

# HIQ home automation

Manual v1.7 rev 2

# Content

## General

Overview	1
Features	2
Feasibility	3
Layout	4
Usage	5
Expansion	6
Background	7

## Features

Lights and blinds	8
RGB dimmer	9
Scene	10
Automatic lights	11
Simple automation	12
Ready light	13
Evo light	14
Heating and cooling	15
Timetable	16
Key concepts	17
Automation	18
Alarm	20
Access control	21
Energy	22
Customization	23

## Software

HIQ Configurator	24
HIQ Commander	25
HIQ Universe	26

## Hardware

PS-IQ power supply	27
HC-IQ home controller	28
LC-10-IQ light controller	29
LD-V4-IQ LED dimmer	30
LD-P4-IQ universal dimmer	31
LD-D8-IQ DALI dimmer	32
BC-5-IQ blinds controller	33
SC-4-IQ scene controller	34
TH-1-IQ thermostat	35
TH-2-IQ thermostat	36
TH-3-IQ thermostat	37
FC-1-IQ fan-coil actuator	38
SDM-120C power meter	39
IR-580-IQ and other sensors	40
AS-24RA touchless switch	41
Wiring	42
Switch panel	43
Dimensions	44
Order code	45

# Overview

sensors - controllers - actuators - interface

# HIQ

- comfort
- simplicity
- security
- safety
- practical
- flexible
- cost-effective

HIQ is a home automation system, including lights, blinds, heating and cooling; temperature monitoring, energy management, timetable, event-based automation and alarm.

HIQ consists of both hardware and software. Devices are connected to each other with a common power supply and communication bus.

Although basically simple, expansion capabilities are virtually unlimited. System is configurable, programmable, and allow integration of multiple HIQ installations into a single functional unit.

HIQ can be used for a new project and renovation. Most of the work is done by a common electrician, no specialized expert is needed. Most of the configuration is done by end-user.

System design is very simple, there are no complicated compatibility or dependency rules.

HIQ is fully open to work with many other home devices, either by integrating them in the system (e.g. touchless buttons), or cooperate on the signal level (e.g. professional alarm).



# Features

new concept with unique features

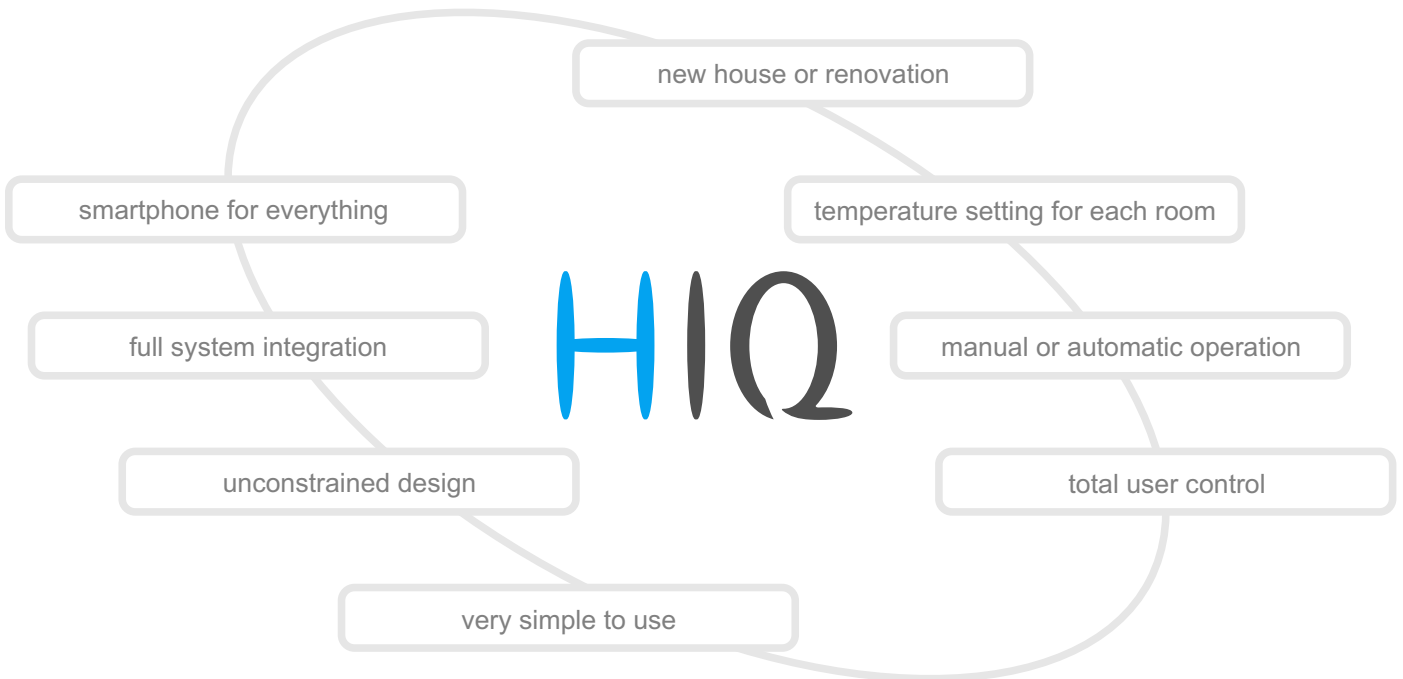
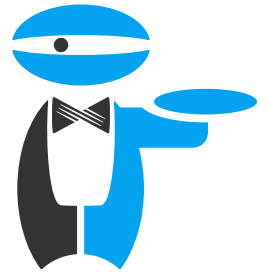

## Multiple timetables

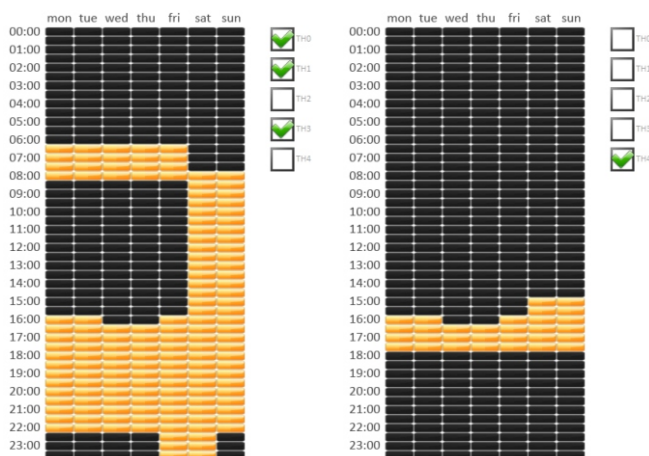

Set things running up to your schedule. To configure the timetable, select active hours, then select devices to be affected. You can manually override output at any time.

## Advanced RGB control

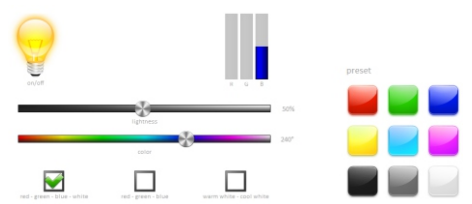

RGB mode allows control of hue, saturation and brightness; instead of individual red, green and blue channels.

In white temperature mode, output goes between different kinds of white, from bright daylight to warm incandescent light.

Evo light function provides synchronization between light temperature and time of day. In the evening, lights will automatically reach the warmer tone.

# Feasibility

suitable for most lodging solutions



small house



large house

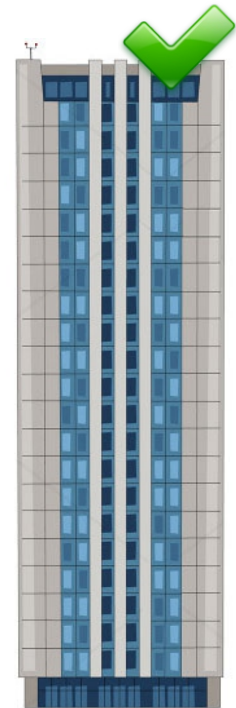

highrise



apartment building



office building



urban house



farm house



cottage



new house



full renovation



partial retrofit

HIQ system is suitable for house or apartment, small or large, residence or weekend house. It may not be the best choice for a partial or temporary retrofit, where wireless solution is preferred.

# Layout

from a switch to the cloud computing

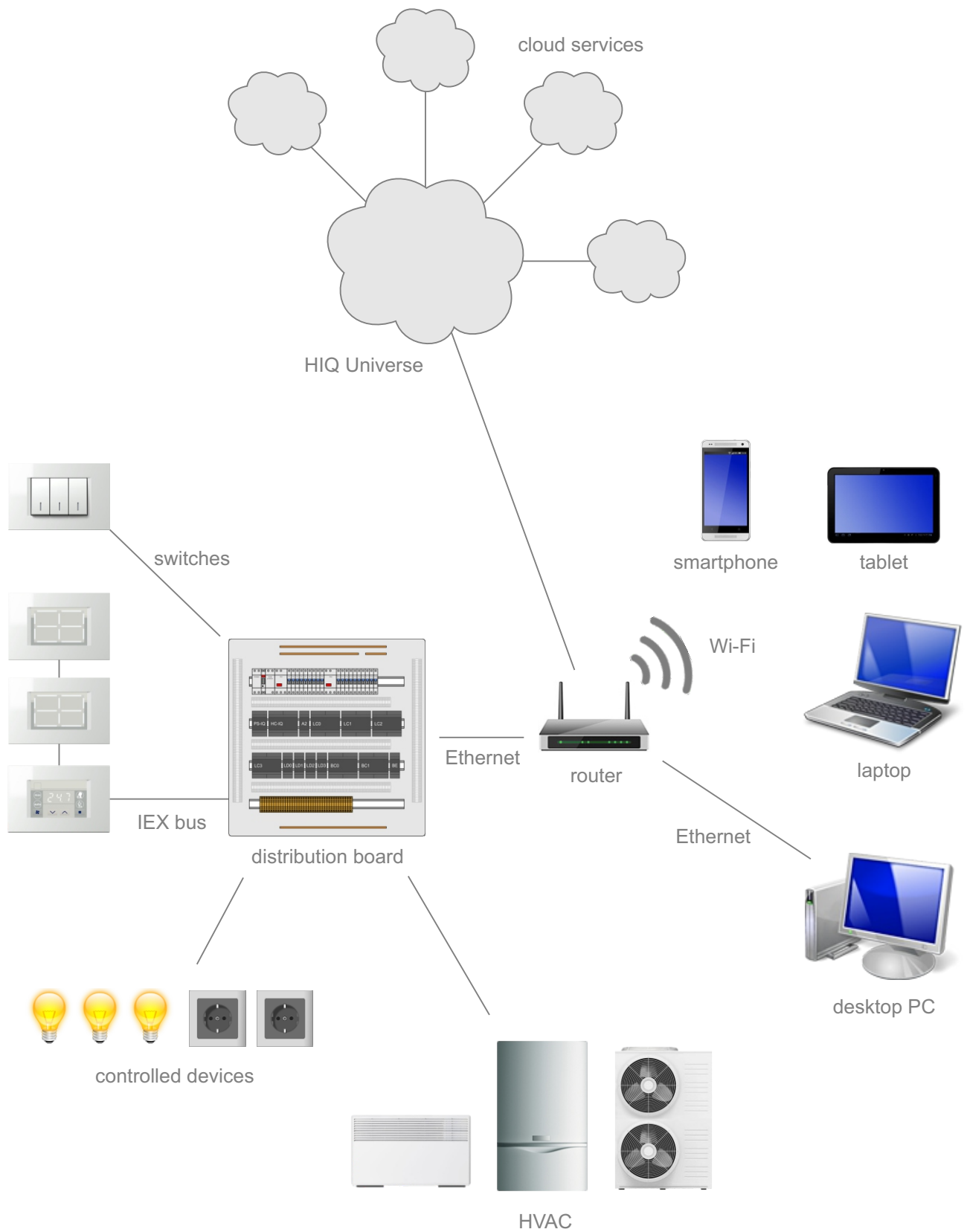

# Usage

what all this hardware is for

Device	Used for
	<p>LC-10-IQ light controller</p>
	<p>halogen and LED downlighters, all kinds of general-purpose lights</p>
	<p>managed socket for floor lamp, table fan, hi-fi system, projector, and all kinds of appliances</p>
	<p>LD-V4-IQ LED dimmer</p>
	<p>LED stripes</p>
	<p>LD-P4-IQ LD-D8-IQ universal dimmer</p>
	<p>dimnable lights of all kinds</p>
	<p>BC-5-IQ blinds controller</p>
	<p>window blinds, shutters and jalousies</p>
	<p>SC-4T-IQ scene controller</p>
	<p>SC-4S-IQ scene controller</p>
<p>user-selectable arrangement of lights and blinds</p>	
	<p>TH-1-IQ TH-2-IQ TH-3-IQ electronic thermostat</p>
	<p>heating, cooling and fan control</p>
	<p>FC-1-IQ fan-coil controller</p>
	
	<p>HC-IQ master controller</p>
<p>smartphone and PC connection, automation, timetable, alarm, energy and other functions</p>	

# Expansion

out-of-the-box and project-based features

## Basic configuration

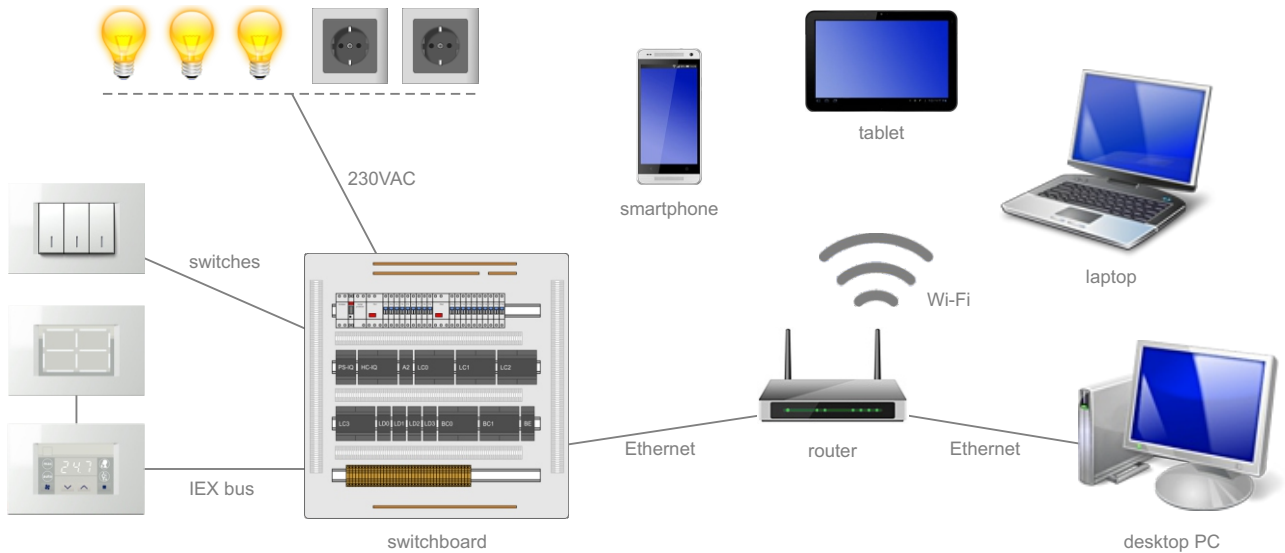

One basic configuration covers approximately 200m<sup>2</sup>, or one floor in a multistory object.

## Advanced system



HIQ system offer many out-of-the-box functions. However, modern home automation is all about integration, and that is where the HIQ excels. HIQ is capable of connecting various devices into a functional system. Integration is project-based, each home is attuned to investor and building requirements.



# Background

technical experience behind the product

## Design

Cybrotech originate from industry control and automation, all devices are designed and build up to a much higher standards then usually expected in home automation.

## Features

- hardware watch-dog
- transient supression
- short circuit tolerant outputs
- reverse polarity tolerant supply
- wide temperature range

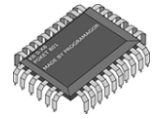

## Addressing

Devices are addressed automatically, not a single address is set by user.

## Firmware

All devices are build to implement firmware upgrade, so the future for your investment is assured.

## Responsive

From keypress to action, typical reaction time is 10 milliseconds.



**CAN bus** is a multi-master, deterministic bus which offer optimum between performance, network architecture and cost.

## Power consumption

HIQ take a great care to use as little electricity as possible.

**Autorange** inputs always ensure a full scale motion.



## No batteries

The whole system is operated from a single 24V power supply.



**No hidden costs** at any level - everything is simple and elegant (and beautiful, too).

**Programming tools** are free, everybody is welcome to give it a try. Only a basic programming skills are needed. Join our group and discover how fun and simple house automation can be.



## Wire vs. wireless

- no batteries
- more reliable
- faster response
- less EMI pollution
- simpler setup
- lower price



We don't sell switches, luminaries, computers, portable devices, tablets or phones; you have a freedom to select anything you like, buget models or expensive designer items. What we do sell is electronics, software and home automation experience at it's finest.

# Lights and blinds

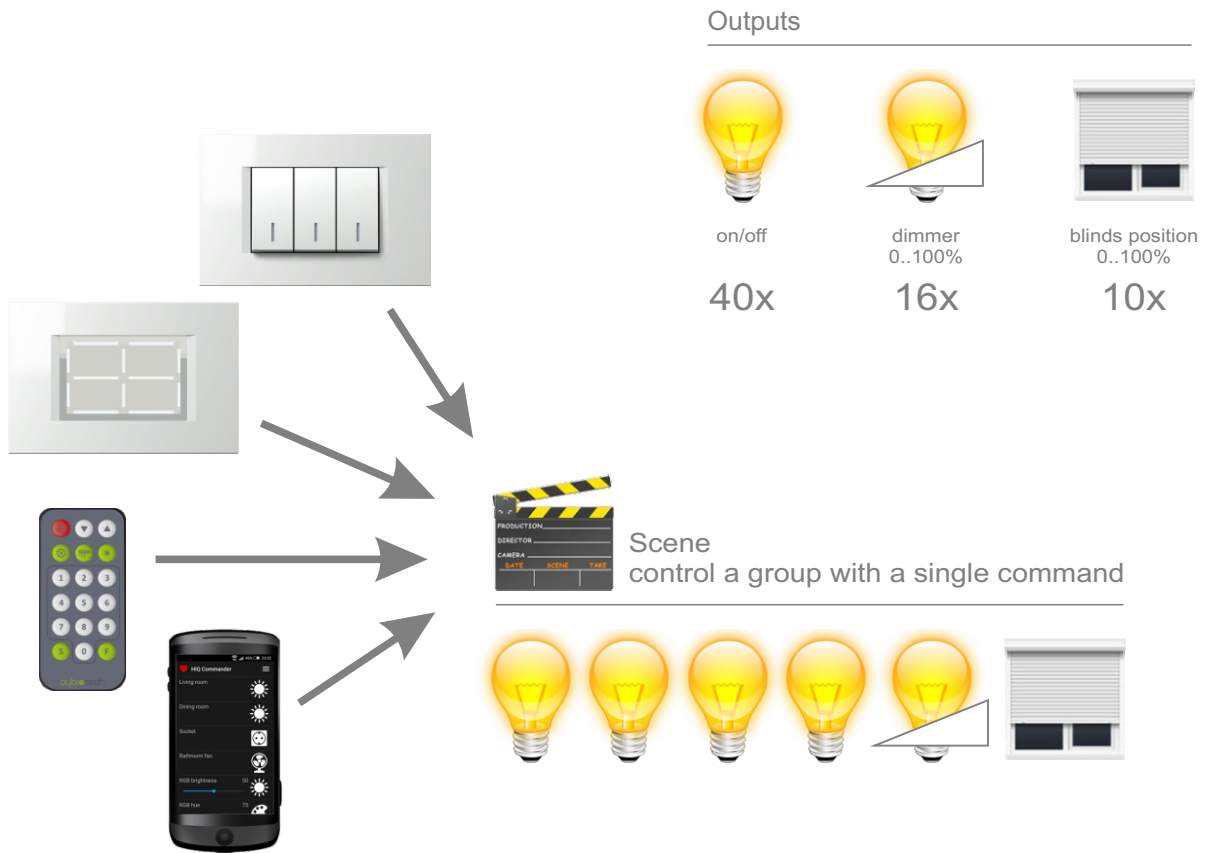

control everything from everywhere



## Light type

-  incandescent/halogen
-  compact fluorescent
-  compact LED E27/E14
-  LED strip 12/24V

## Blinds type

-  classic blinds
-  slatted blinds
-  Roman shades
-  managed socket for a floor lamp, table fan, dehumidifier, electric mosquito repellent, hi-fi system
-  blinds control with an intermediate position

# RGB dimmer

hue, saturation and brightness

In RGB mode, dimmer channels are connected to red, green, blue and white lights. White channel is optional. Instead of individual channels, user controls total brightness, hue and saturation.

RGB dimmer may be used in white temperature mode. Here, user controls brightness and white temperature. White light is obtained by mixing all four channels. For best result, use white strip 2700K (warm white) and RGB strip 5600K (cool white).

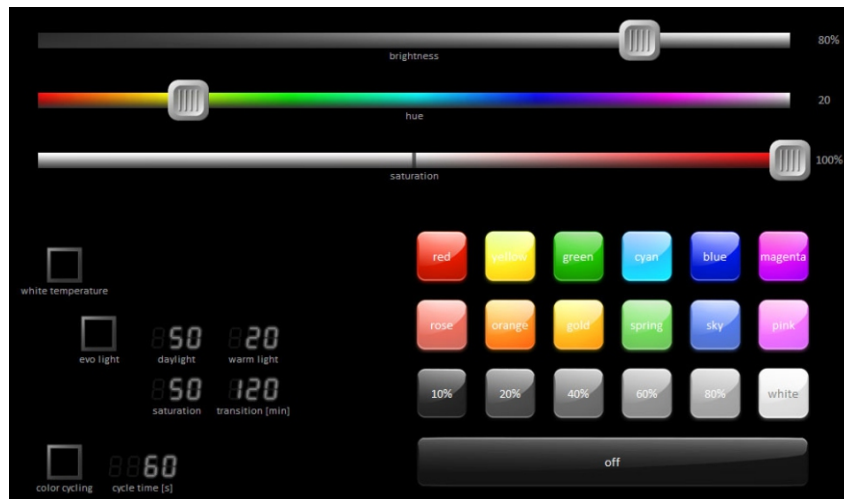

## White temperature

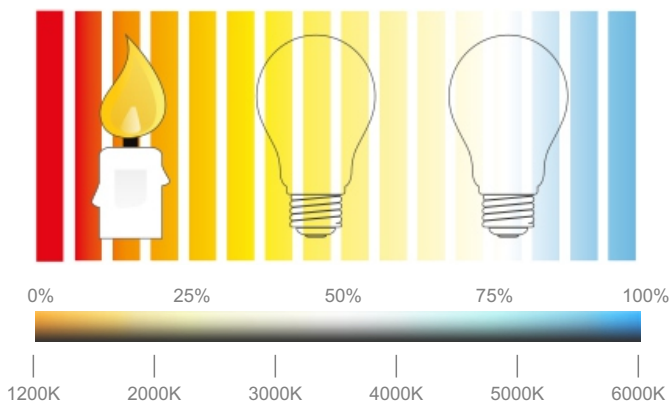

In RGB mode, saturation goes from white to selected color (0..100%). In white temperature mode, saturation goes from natural white (white strip) to selected white (0..100%).

## Color cycling

Automatically rotate through the available colors. Brightness and saturation are selected manually.



## Color picker

Color picker is a quick way to choose a color, available with the HIQ Commander application. To control the RGB, just touch a color or slide finger over the screen.

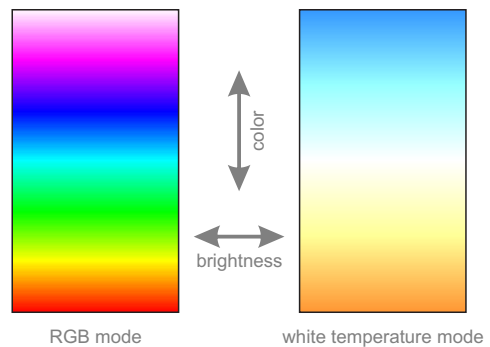

# Scene

one touch to rule them all



Scene is user-defined memory including lights, dimmers and blinds. Each output is either defined by scene (on/off, lightness and position), or not affected.

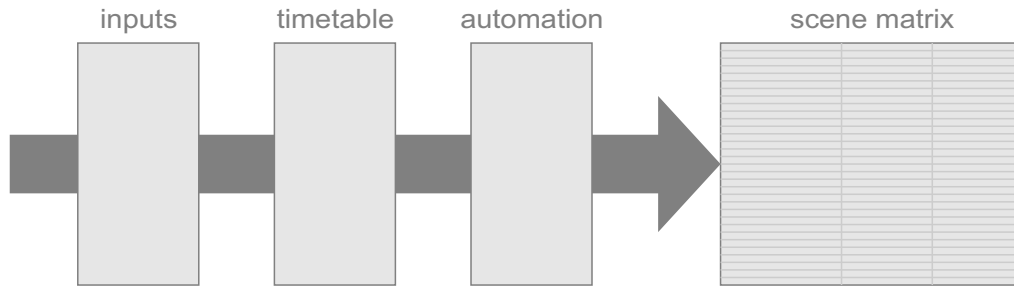

## Scene mapping

SC0	0
	1
	2
	3
SC1	4
	5
	6
	7
SC2	8
	9
	10
	11
SC3	12
	13
	14
	15
	16
	17
	18
	19
	20
	21
	22
	23
	24
	25
	26
	27
	28
	29
	30
	31

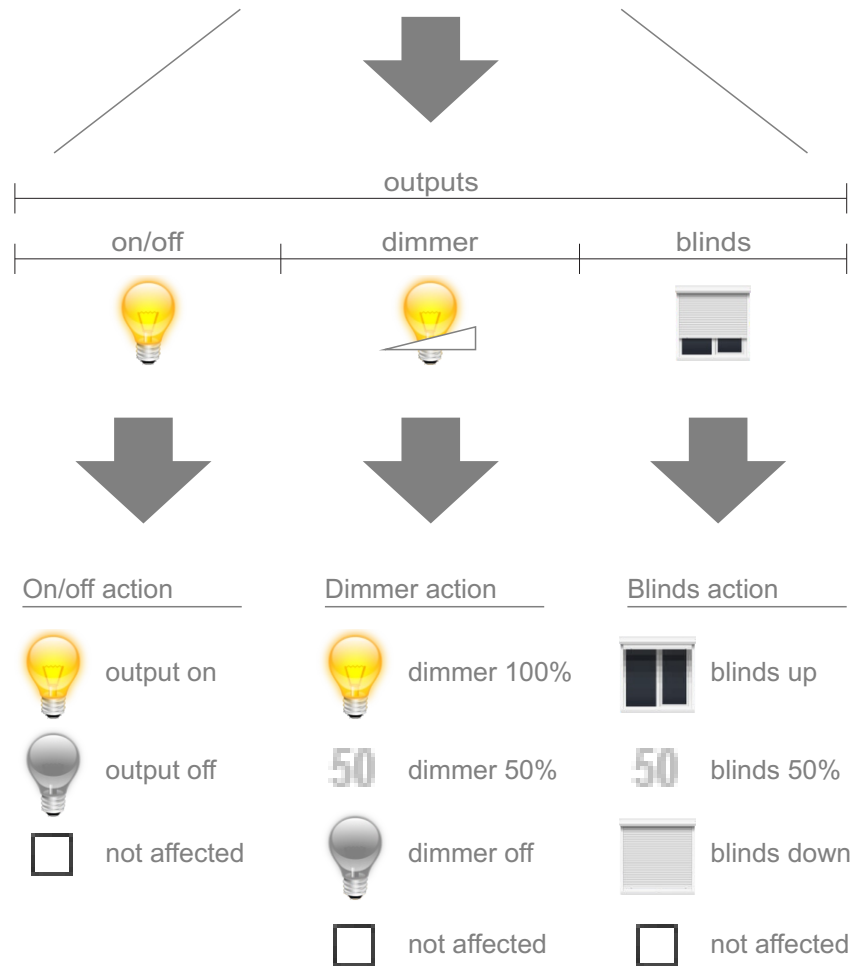

Hint: use scene 31 to turn all lights off.





Scene is initially created with HIQ Configurator. Once saved, it can be modified with a long press.

# Automatic lights

where and how to use automatic lights

Benefits of automation depend mostly on how the space is used:



-  smart light
-  ready light
-  motion sensor
-  door sensor
-  manual control

Smart light is based on low light and presence signal, and it is used for a main living space. It can be combined with evo light to control light temperature during the evening.

Ready light take advantage of door and motion sensors. It is suitable for a space used occasionally, like a bathroom.























Motion sensor cover open spaces, hallway or porch.

Door sensor cover small rooms used temporary, like a closet, cloak or wardrobe.

Other areas, like a bedroom, are handled manually.

# Simple automation

light automation based on a single sensor

usage	input mode	output mode	description
on/off			press on, press off
on/off + timer			press on, press off in case light is left on, timer turns it off
staircase			press on press again to reload the timer when timer expires, light goes off
doorbell			press on, release off
scene			press to set multiple lights press again to turn the scene off
motion sensor			movement is keeping the light on when timer expires, light goes off
			movement is keeping the light on when timer expires, light goes off active only during the night
door sensor			open door to turn the light on close door to turn the light off
			open door to turn the light on close door to turn the light off active only during the night
ready light	 		advanced automatic light control
not used			input only, used for custom functions

# Ready light

advanced automatic light control

Ready light is an advanced lighting system, based on motion and door sensors. It is best suited for closed spaces that residents don't occupy permanently.

### Features:

- instant on as soon as door begins to open
- never turn off while somebody is inside
- quickly turns off when everybody is out

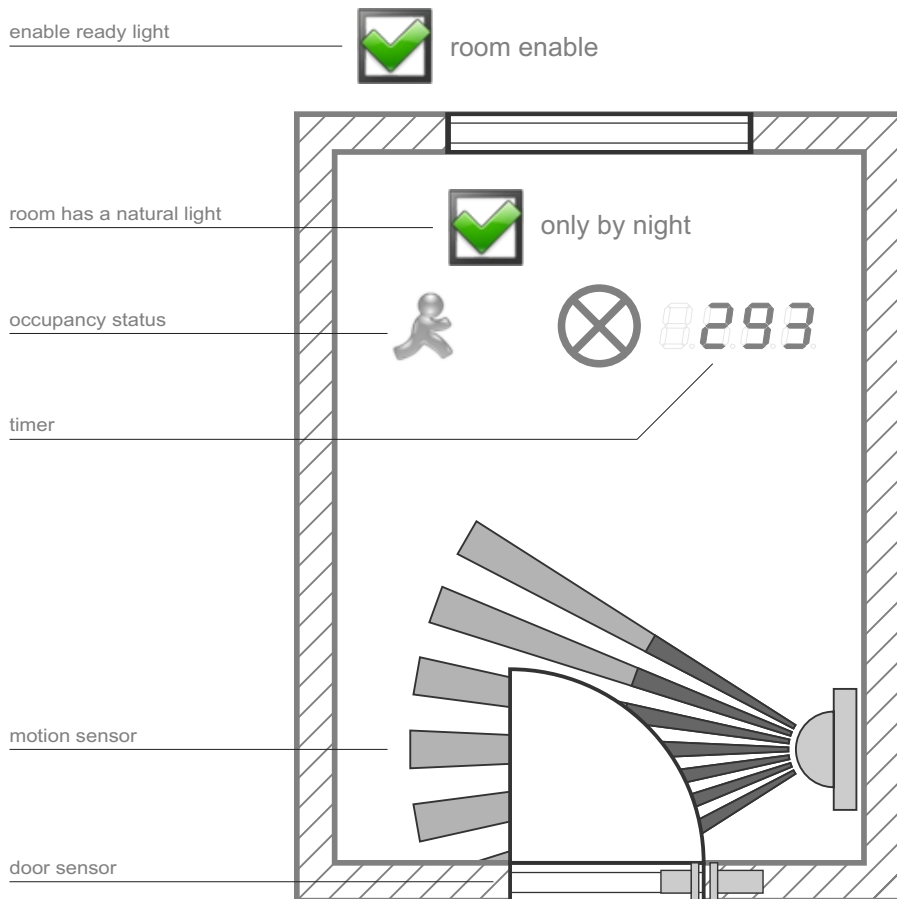

### Input setup

Sensors are connected to spare inputs of light controller. Input must be configured to ready light mode.

### Sensor placement

For a best result, sensor must be activated just after person closes the door.

### Short timeout

Time from closing the door to light off. If time is too short, light may turn off after entering the room.

### Long timeout

Time from leaving the room to light off, without closing the door.

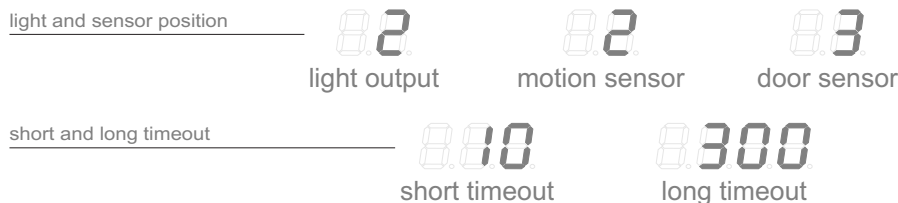

Patent rights granted 2016-04-29 by patent office Slovenia, number 24867, class G06F 9/00.

### How it works

When door begins to open, reed sensor is activated and the light turns on. When a person enters the room and closes the door, PIR activation means person is surely in the room. As long as door is closed, light will stay on. When person leaves room and closes door, system will wait for a short time, then turn the light off. If the door is left open, long timeout is active. If the PIR sensor is not activated during that time, light switches off.

# Evo light

automatic transition to warm evening lights

Evo light is a half-automatic system for controlling light temperature. It uses RGB dimmer in white temperature mode. Brightness is controlled by user, hue and saturation are controlled by the system.

During the selected period, lights are going from a cool white to warm white, perfectly matching our natural daily cycle.

System can be combined with smart lights. In that case, operation is fully automatic, smart lights control brightness, and evo light control light temperature.

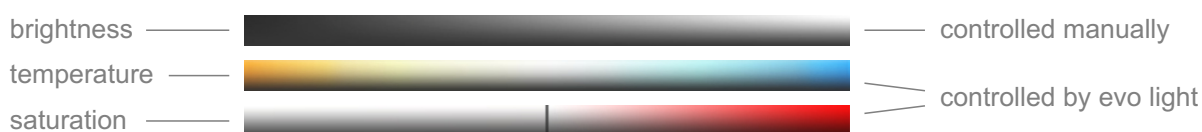

Term evo is a short for 'evolution'. During the most of our evolutionary past, our ancestors were using no artificial lighting, so daily rhythm was synchronized by sunlight. Evo light is an attempt to mimic that natural conditions.

## Operation

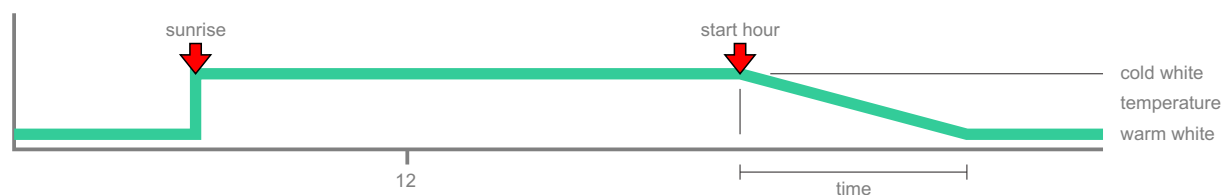

To configure evo light, first experimentally find the best light for early and late evening. Start hour and transition time should be configured so the warm light is reached at least one hour before bedtime.

When dimmer is switched back to RGB mode, evo light will automatically stop. Enabling again, it will catch on correctly, recalculating the new parameters.

Note: evo light setup is located on RGB page.



# Heating and cooling

general features of heating/cooling system

## Heating/cooling

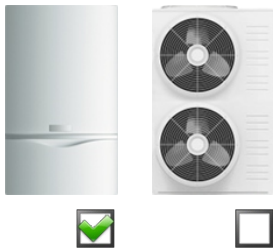

## Energy demand

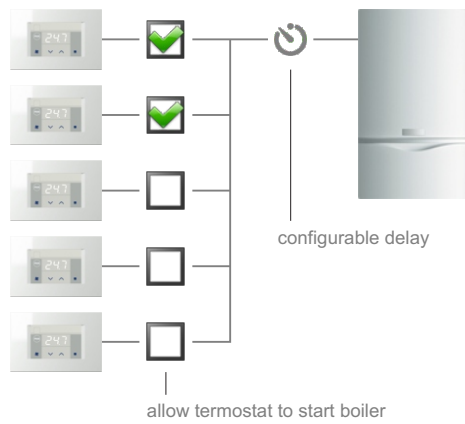

Up to five regulation zones are supported, each with their own thermostat. Generally, energy comes from boiler for heating and chiller for cooling, but other combinations are possible.

## Thermostat



## Actuator

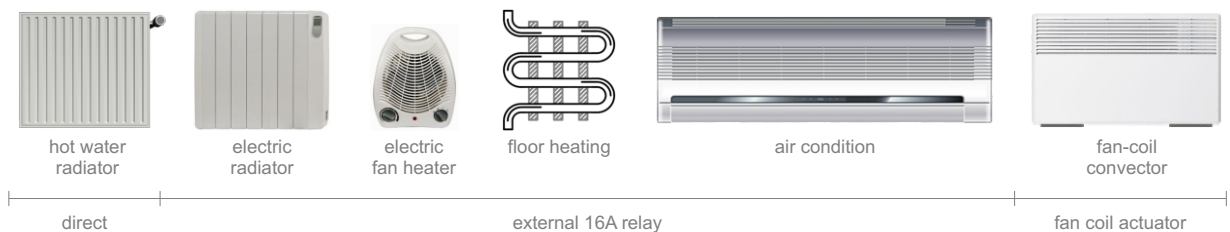

System is versatile enough to handle most actuator options. Hot water valve is connected directly, others require either external power relay, or fan coil actuator. Different actuator types can be mixed.

## Examples

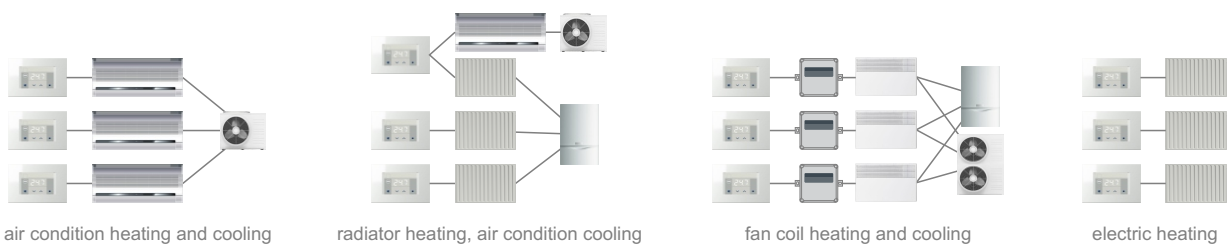

# Timetable

weekly event scheduler

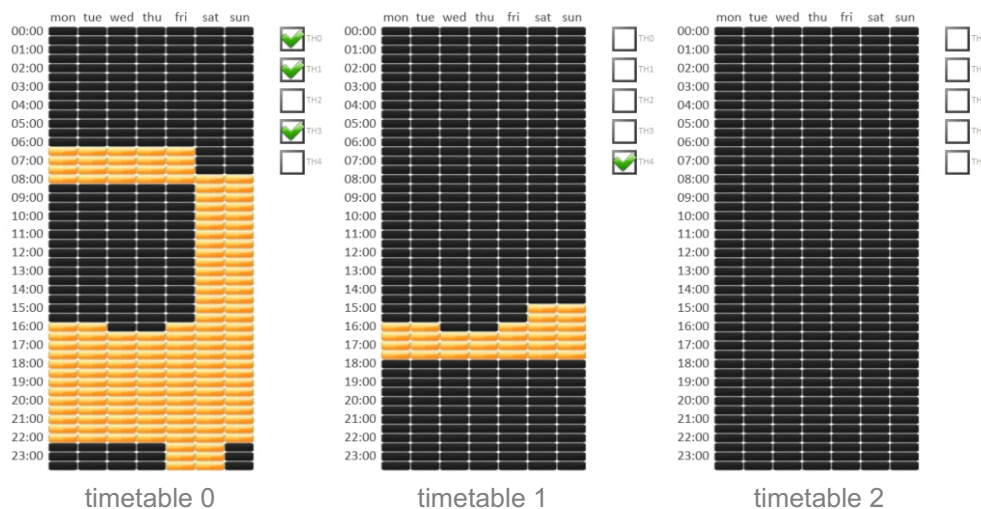

Each timetable can directly control an output or apply a selected scene.

Selected part is a period when heating system is active. Each rectangle represents a half hour. Tables are fully independent of each other. To set multiple fields, hold left button and drag mouse.

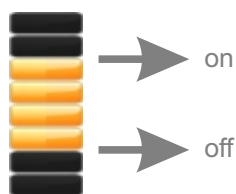

Each block create on and off event.

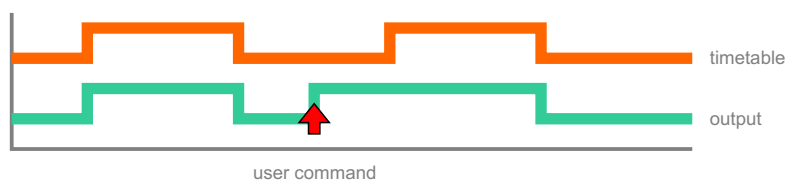

When timetable controls an output, manual override is possible at any time, timetable will catch on with the next transition.

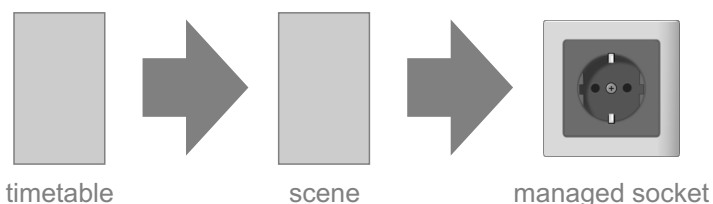

Timetable can be used to control mostly anything. Use a managed socket to create a time plan for your devices.

# Key concepts

low light and presence signal

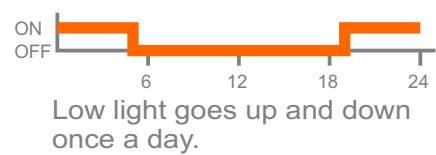
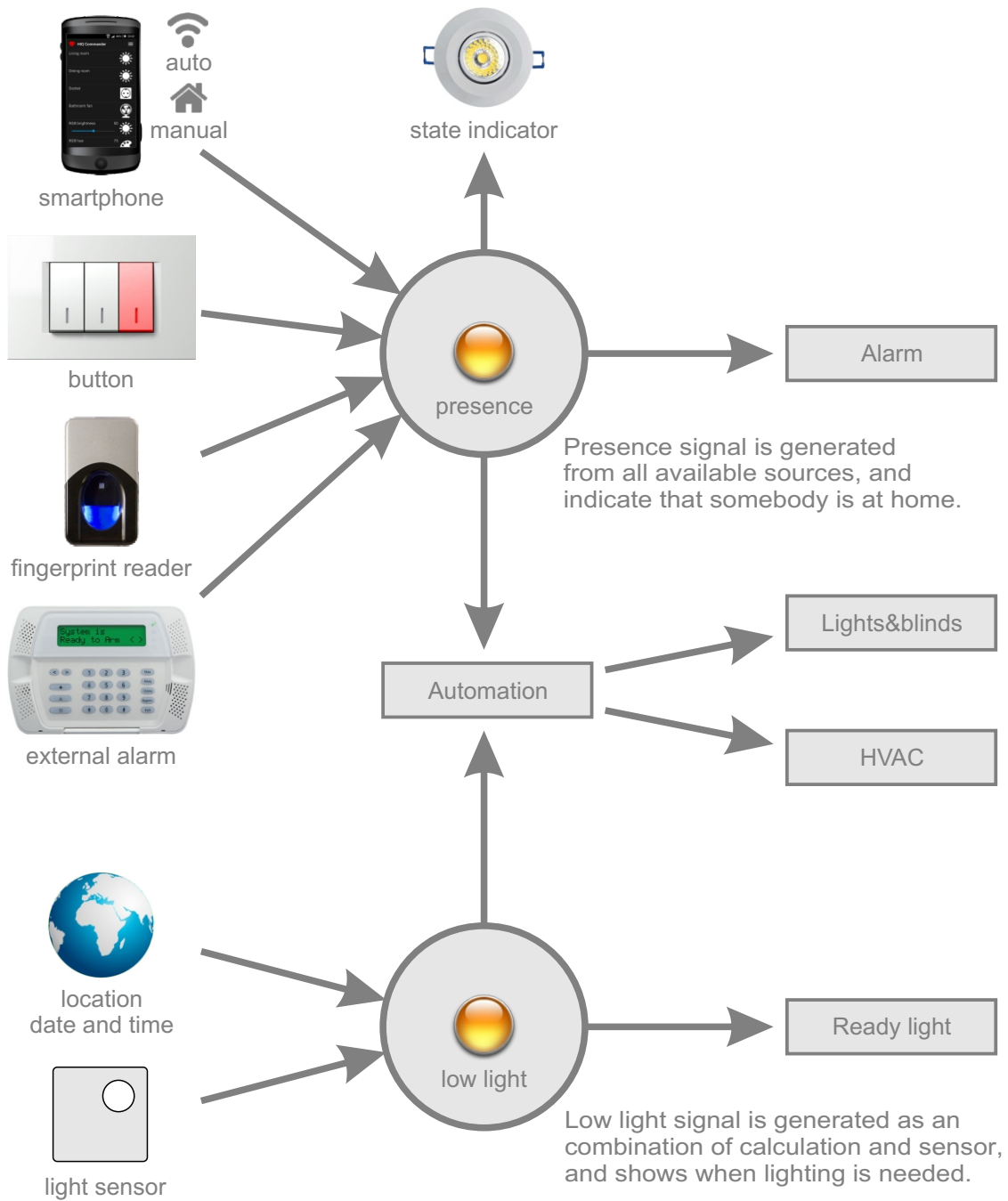

# Automation

execute tasks automatically



## Coming home

Let your house show how happy it is when you come back home. When phone connects to your wi-fi network, lights and heating will turn on automatically.



## Default setpoint

When active, any setpoint adjustment is valid for about half hour, then it returns to the temperature defined in automation setup.



## Leaving home

When you leave the house, smartphone disconnects from home wi-fi network, a few minutes later system will turn lights and heating off.



## Bio offset

Following your natural biological rhythm (chronotype), let the house be a little warmer (or cooler) at the specified time of the day.



## Smart lights

In the evening hours, when sunlight goes down, automatically set evening scene, turn on the lights and lower blinds. Works only when tenants are at home.



## Connect charger

Do you charge your phone every day before going to bed? Use that action to automatically turn lights and heating off.



## Random lights

When nobody is at home, discourage snooping with a simple deception: turn lights on and off to leave impression that house is not empty.



## Disconnect charger

Phone is charged until morning, right? When disconnecting the charger, automatically turn lights and heating on.



## Comfort wake up

System will turn thermostat on a predefined number of minutes before smartphone rings, whenever you set the alarm.



## Call notification

When you receive a call, selected light will turn on and off a couple of times, to bring the attention when phone is away or silenced.



## Sunny wake up

Wake up naturally, by gradually lifting blinds and let the sunlight wake you up, a predefined number of minutes before smartphone alarm.



## Text notification

When you receive a text message, selected light will turn on and off a couple of times, to bring the attention when phone is away or silenced.

The most frequent question about home automation is - how to turn the damn thing off. However, regardless the inglorious reputation of smart machines, we strongly believe HIQ will gradually grow up into your daily routine. Events are generated automatically, you are in charge to assign actions according to your preferences.

### Coming home

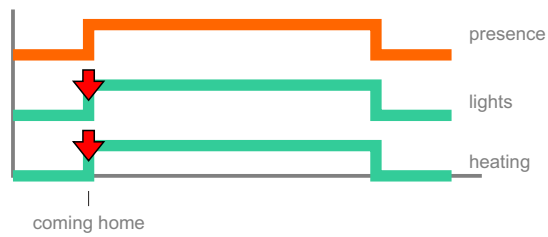

Use presence signal to set the scene and turn the heating on.

### Leaving home

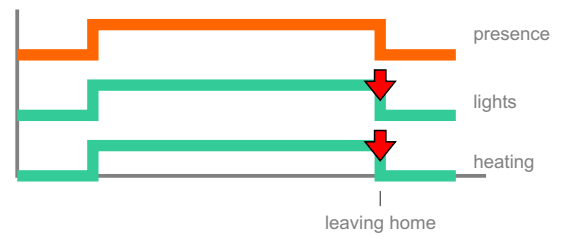

Use presence signal to turn the lights and heating off.

### Smart lights

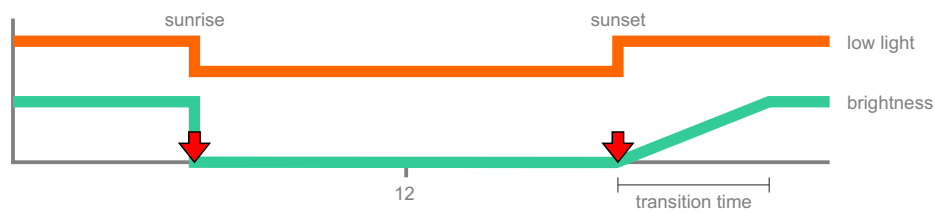

Automatic lights with an optional slope control, synchronized with the low light signal. Smart lights are also dependent on presence signal.

### Random lights

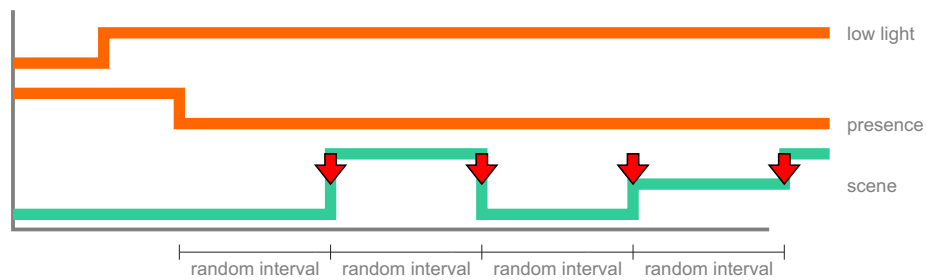

Turn the lights on and off to leave the impression that house is not empty, to discourage burglars.

### Comfort wake up

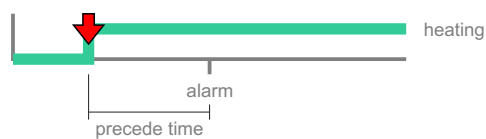

Turn the heating on a few minutes before the alarm clock.

### Default setpoint

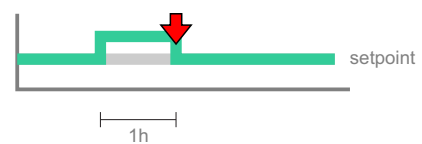

When setpoint is adjusted manually, one hour later return it to the predefined value.

### Sunny wake up

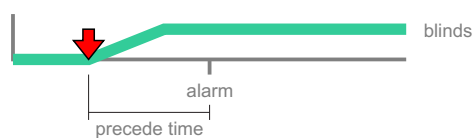

Lift the blinds up a few minutes before the alarm clock.

### Bio offset

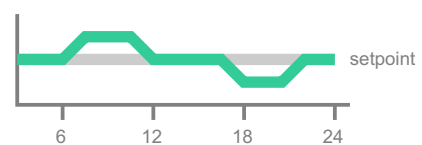

A minute temperature correction depending on time of the day. Adjustable up or down.

# Alarm

security at no additional cost

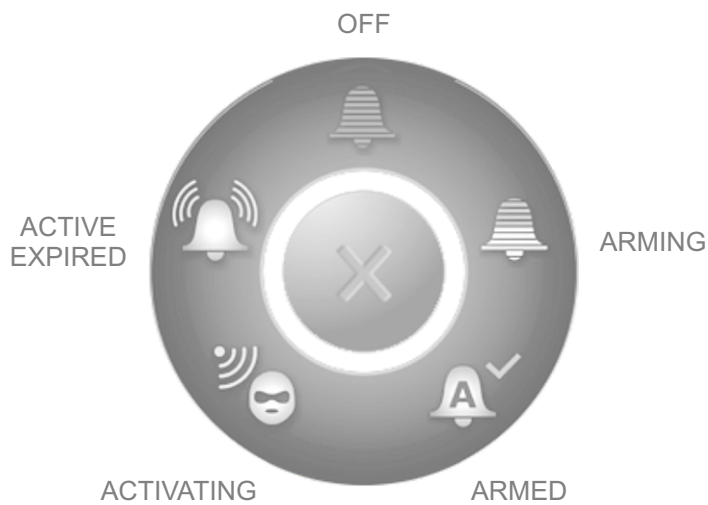

OFF	alarm inactive
ARMING	alarm turned on and will be armed when time expires (default 30s)
ARMED	alarm ready, no intrusion
ACTIVATING	sensor activated, alarm has to be turned off before delay time expires (default 30s)
ACTIVE	burglary, siren output active
EXPIRED	delay time expired, siren is turned off (default 120s)

## Alarm on/off

- longpress on a selected wall switch
- smartphone using HIQ Commander
- smartphone by connecting to wi-fi (Android only)
- PC with HIQ Configurator
- PC with HIQ Configurator and 4-digit code
- automatically with presence signal

## On/off indicator

- small light connected to an output
- blinking of a selected light
- smartphone with HIQ Commander
- PC with HIQ Configurator

## Zone covering

- zone 0 - house exterior
- zone 1 - ground floor, living area
- zone 2 - first floor, sleeping area

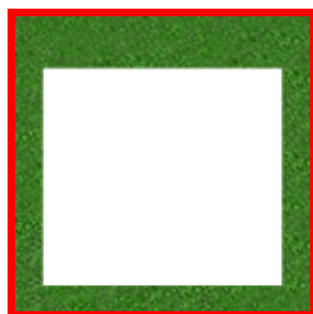

zone 0  
residents at home  
minimum security



zone 0+1  
residents sleeping  
partial security



zone 0+1+2  
residents away  
full security

# Access control

unlock front door automatically

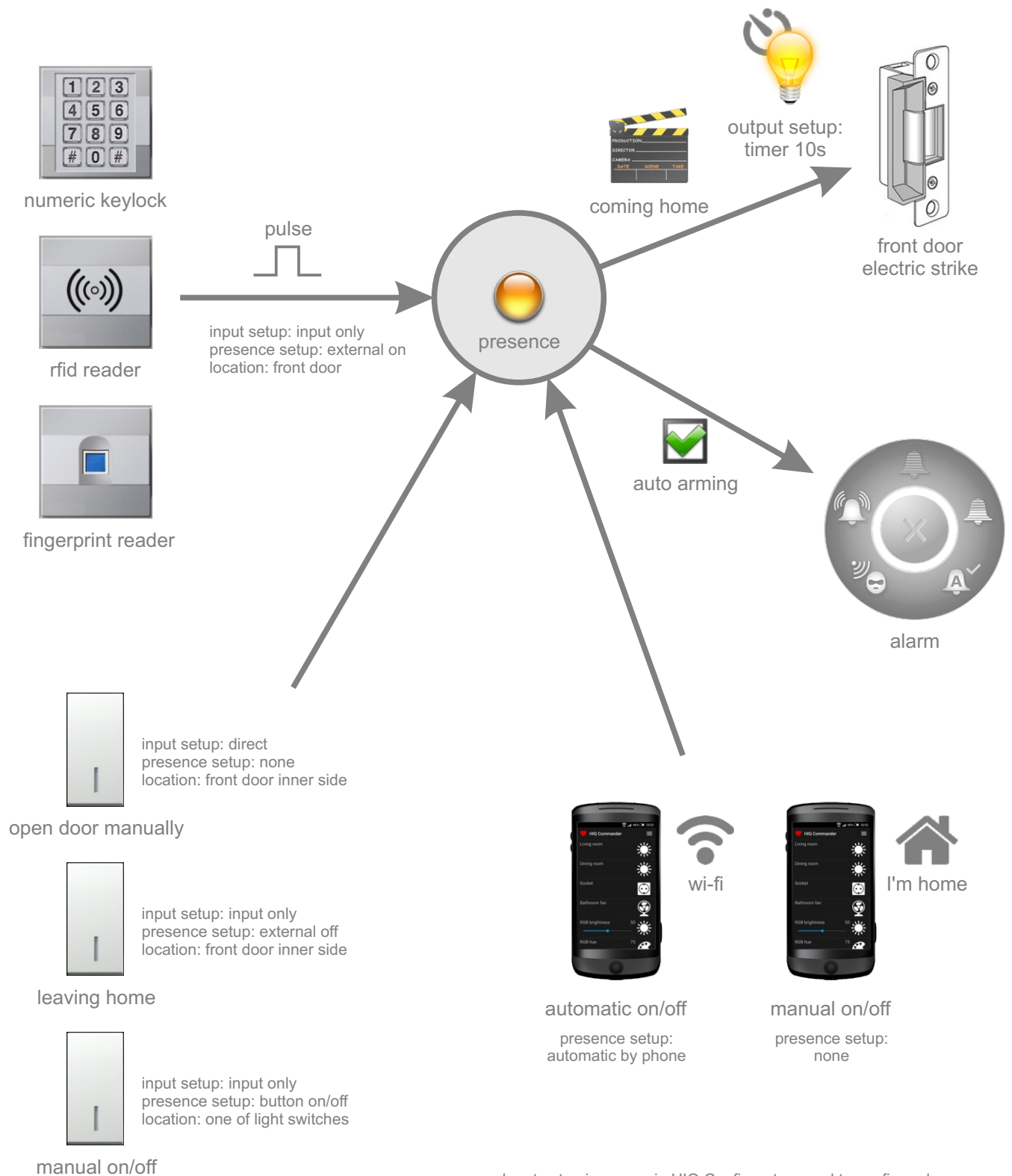

Input setup is a page in HIQ Configurator, used to configure how an input affects its related output. Presence setup is a part of Automation, used to configure what will activate the presence signal, and what will be activated by the presence signal. Location is a place where device is expected to be installed.

# Energy

electricity measurement

Energy monitoring is the first step to efficient energy usage. Once knowing how much energy something is using, one can make a rational strategy for saving.

## Required hardware

SDM-120C power meter  
CAD-232-A2 converter

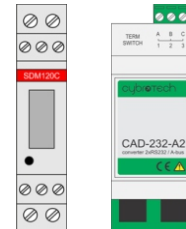

## Energy consumption in last 30 days [kWh]

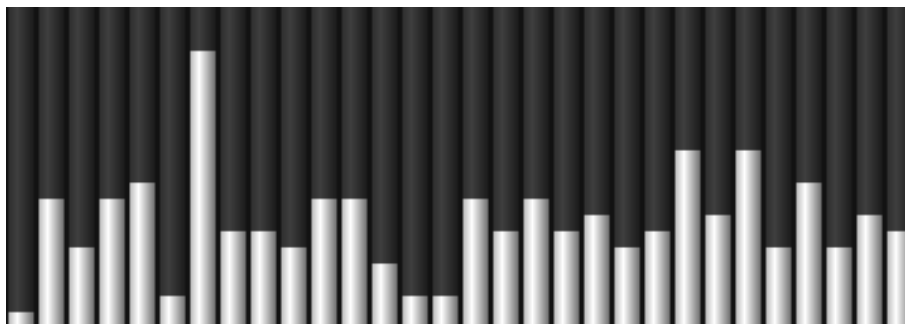

Bargraph for last 30 days is a quick way to check for an excess consumption.

## Energy by output

Power count - a number how many times the output is turned on.

Working hours - total number of hours the output spent in on state.

Nominal power - output power configured by user. It can be measured by resettable power meter, or read from the label.

Current power - output power at the current moment.

Energy today - total energy used from last midnight, expressed in Watt-hours.

Energy total - total energy consumed by the specific output.

How to measure the amount of electricity something is using

1. Turn the output off.
2. Reset relative power.
3. Turn the output on.

A few seconds later, measured relative power is displayed. If the reading is not stable, temporary turn off any load which may consume variable amount of power.

Measured rating may be used to set the nominal power on 'By output' page.



# Customization

get the maximum out of your system

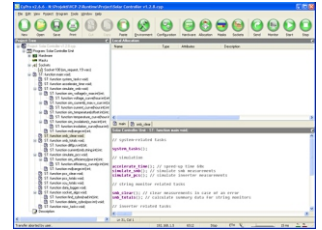

integrated development environment

The goal of customization is to add functionality related to some specific needs. HIQ system is flexible and open for all kinds of modifications. This page will give a short overview how to start with modifications.

Customization is for the one who wants to get the maximum out of the system. It requires a basic programming skills. Programming language is «structured text», a kind of simplified Pascal. Development environment (editor, compiler, on-line monitor) is called CyPro, and it is free to download from the company web site.

standard HIQ system



custom program



custom devices

### Modify HIQ program

- load program source directly from controller
- put your code into custom\_algo module
- send modified program back to controller

### Combine HIQ and non-HIQ modules

- all HIQ modules are fully IEX compatible
- delete unused HIQ modules from hardware setup
- add your own selection of IEX modules
- modify program according to your needs

### HIQ Commander for non-HIQ applications

- allocate variables for autodetection manually
- use allocated variables in your cybro application
- check Cypro example HiqCommanderDemo

### Non-standard HIQ configuration

- custom selection of modules, e.g. 10x LC-10-IQ
- hardware setup, manually add new modules
- adjust program and mini scada up to your needs

### Modify HIQ Mini View for your house

- no special tools are needed
- configuration consist of one text file and images
- use Notepad to change configuration file
- use an image editor to create custom graphics

### Connect HIQ systems together

- create system as big as you like
- use sockets as a link between controllers
- implement all kinds of commands

## Example

Task: add counter how many times light is switched on

### 1. CyPro

- allocate variable lc00\_qx00\_count, make it retentive
- add the following lines of code into program
- send program to controller

### 2. Mini scada

- open CyBroMiniView.xml in text editor (Notepad)
- add object to xml configuration, inside the first page
- use scada (ctrl-E) to move object to the right place



```
if fp(lc00_qx00) then
  lc00_qx00_count:=lc00_qx00_count+1;
end_if;
```

```
<object>
  <type>led</type>
  <var>c1000.lc00_qx00_counter</var>
  <digits>4</digits>
  <decimals>0</decimals>
  <zeroblanking>1</zeroblanking>
  <sign>0</sign>
  <ledcolor>$FF0000</ledcolor>
  <height>42</height>
  <x>100</x>
  <y>100</y>
</object>
```

# HIQ Configurator

PC application for system setup and configuration



## Install

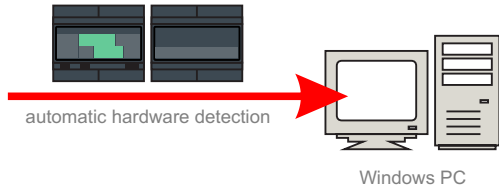

Edit name:  
ctrl-E - edit mode  
right click - rename  
ctrl-E - return to normal mode

## HIQ Configurator

- control center for everything
- universal configuration tool
- screen resolution 1366x768

## HIQ Timeplot

- timeplot for temperatures
- timeplot for consumed energy
- screen resolution 1920x1080

## HIQ View

- template for custom app
- replace floorplan image
- add and rearrange icons

## HIQ Simulator

- test all without the hardware

## Configuration

- ..... output timer
- ..... input mode
- ..... blinds travel time and intermediate position
- ..... graphical scene editor
- ..... ready light
- ..... alarm
- ..... heating and cooling
- ..... timetable
- ..... automation

## System limits

4x		LC-10-IQ light controller	40 on/off outputs
4x		LD-V4-IQ LED dimmer	16 dimmer channels
or		LD-P4-IQ universal dimmer	
4x		LD-D8-IQ DALI dimmer	10 blinds
or		BC-5-IQ blinds controller	
2x		SC-4-IQ scene controller	16 scenes
4x		TH-1-IQ thermostat	5 regulation zones
5x		FC-1-IQ fan-coil controller	
5x		HC-IQ main controller	one central controller

## Autodetect

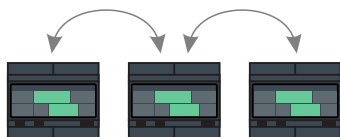

To switch from controller to controller, use Autodetect function.

## Autoaddress

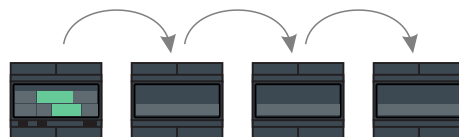

To get all modules in order, use Autoaddress function.

# HIQ Commander

application for your smartphone

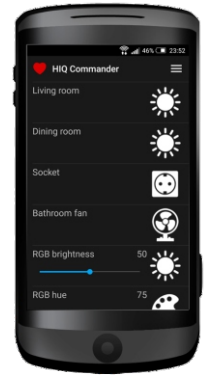
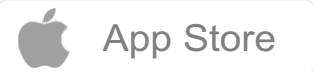

## Autodetect

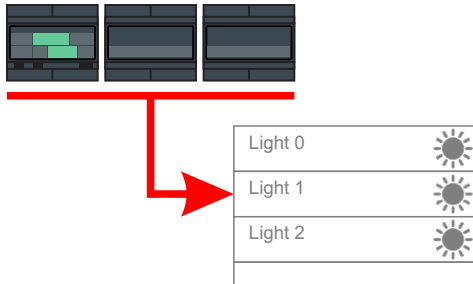

Autodetect must be executed in local network, to discover installed HIQ components and register them on the server. Multiple controllers are listed one after another.

## Rename



## Change icon

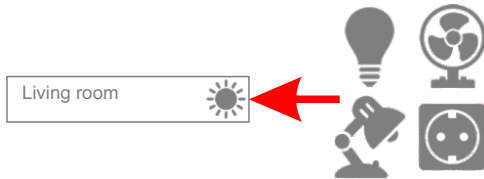

## Rearrange

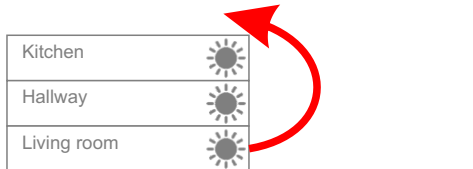

## Remove

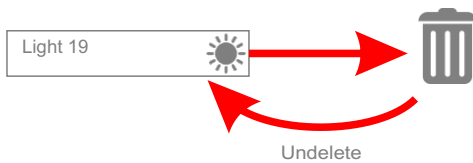

## Copy configuration

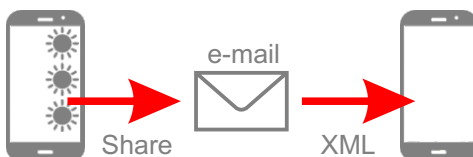

## Features



Features	Android	Apple
direct control for all objects	+	+
coming home leaving home	+	-
warm wake up sunny wake up	+	-
smart lights random lights	+	+
default setpoint bio offset	+	+
connect charger disconnect charger	+	-
call notification text notification	+	-
export configuration to another phone	+	+

## Application limits

HIQ Commander will autodetect more devices then nominal system limits:

- 10x LC
- 10x LD
- 10x BC
- 10x TH

Additional devices are used for project-based features. Number of master controllers is not limited.

# HIQ Universe

cloud access and management

## Local and internet connection

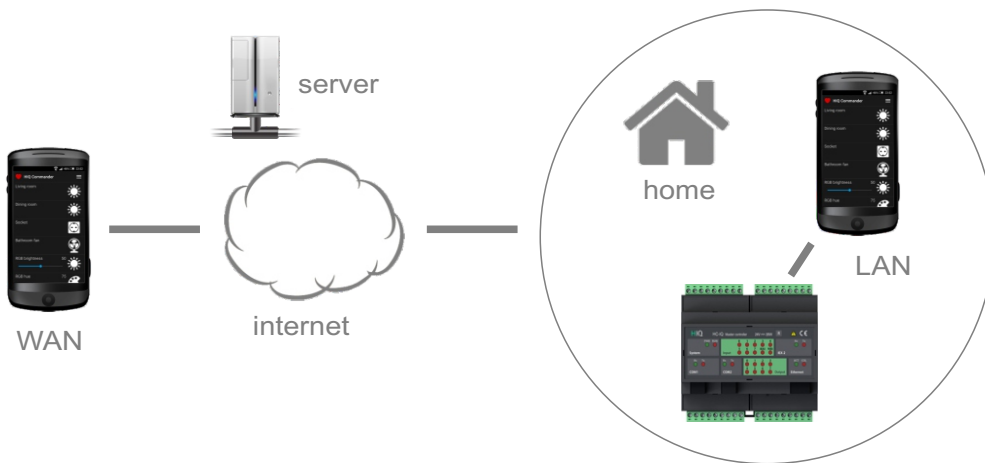

LAN / WAN switching is fully automatic. Number of phones is not limited.

## Remote access and management

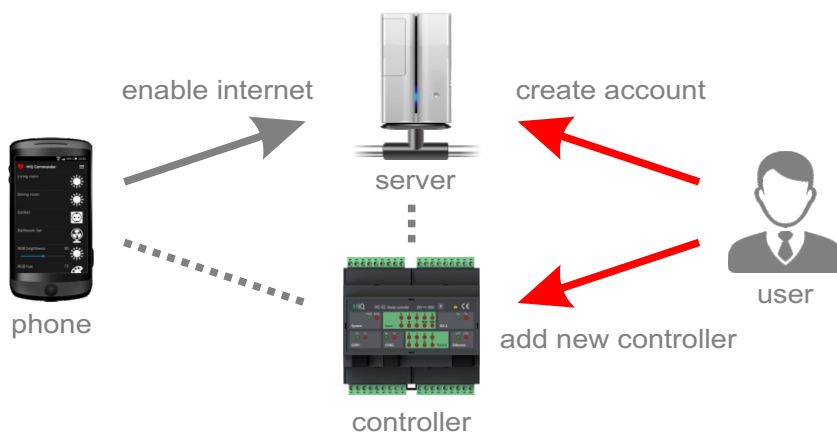

HIQ account consists of two parts, remote access and user account. Remote access is automatically created with autodetect command. User account is created by registering on my.hiq-home.com, and it allows management of connected controllers and phones.

## Account management

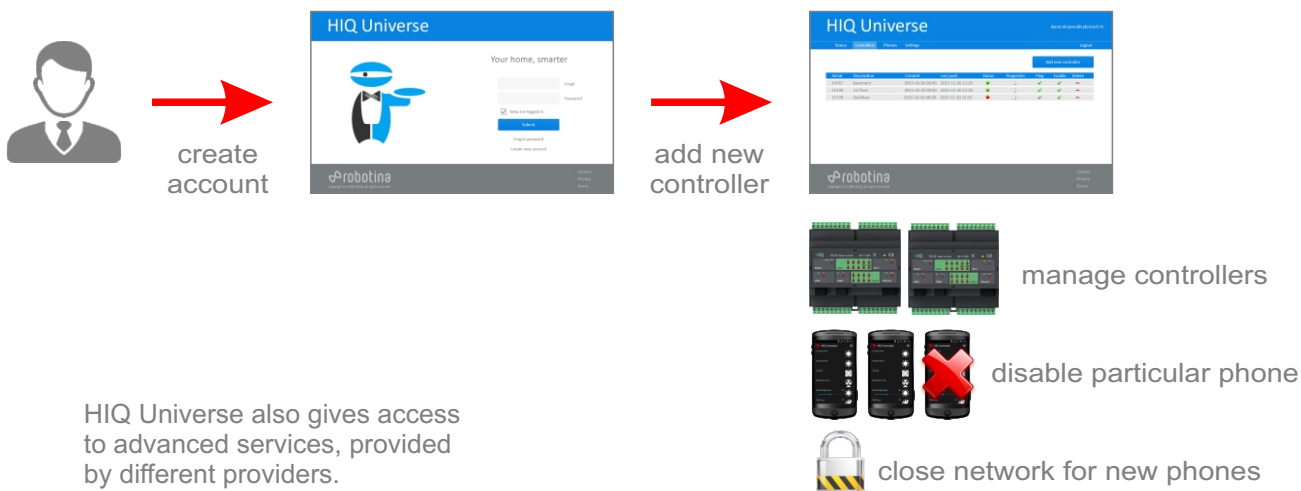

HIQ Universe also gives access to advanced services, provided by different providers.

# HC-IQ master controller

home automation main controller



Mounting: 35mm DIN rail 6M

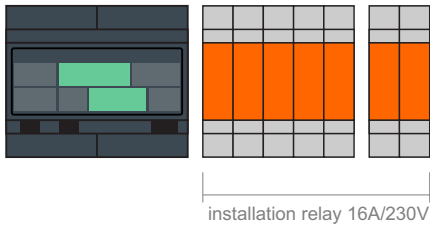
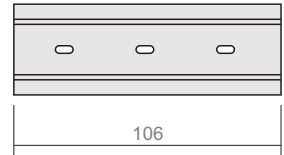

- QX0 - radiator 0
- QX1 - radiator 1
- QX2 - radiator 2
- QX3 - radiator 3
- QX4 - radiator 4
- QX5
- QX6 - boiler
- QX7 - chiller

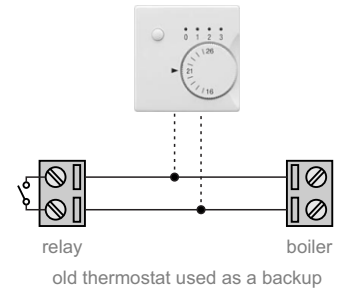
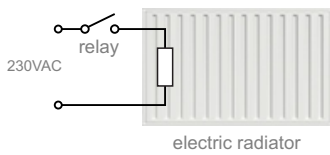
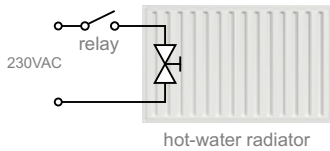
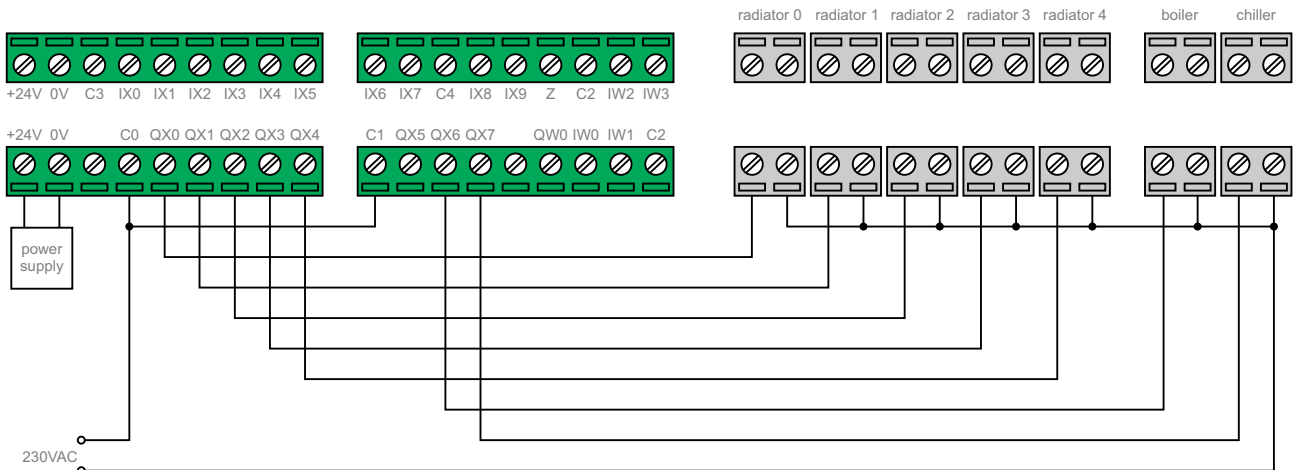

## Features

- smartphone connection
- alarm
- HVAC
- timetable
- automation
- scene link
- internet connection

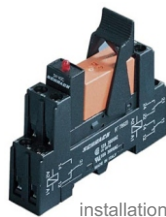

installation relay

Internal relay is used for valves, other loads are recommended to use an additional 16A installation relay.

## IEX-2 © HIQ □ CE

- |                        |  |
|------------------------|--|
| Relay outputs:         | 3A/250V resistive load only  |
| Communication:         | Ethernet 100M  |
| Power supply:          | 24V/50mA   |
| Ingress protection:    | IP20   |
| Operating temperature: | 0..45°C  |
| Storage temperature:   | -20..75°C  |
| Relative humidity:     | 0..95% n/c   |
| Mounting:              | DIN rail   |
| Dimensions:            | 106x108x58mm   |
| Weight:                | 360g   |
| Standards:             | EN 61000-6-2, EN 61000-6-3,<br>EN 61131-1, EN 61131-2,<br>EN 61000-3-2, EN 61000-3-3 |

# PS-IQ power supply

power source for the whole system

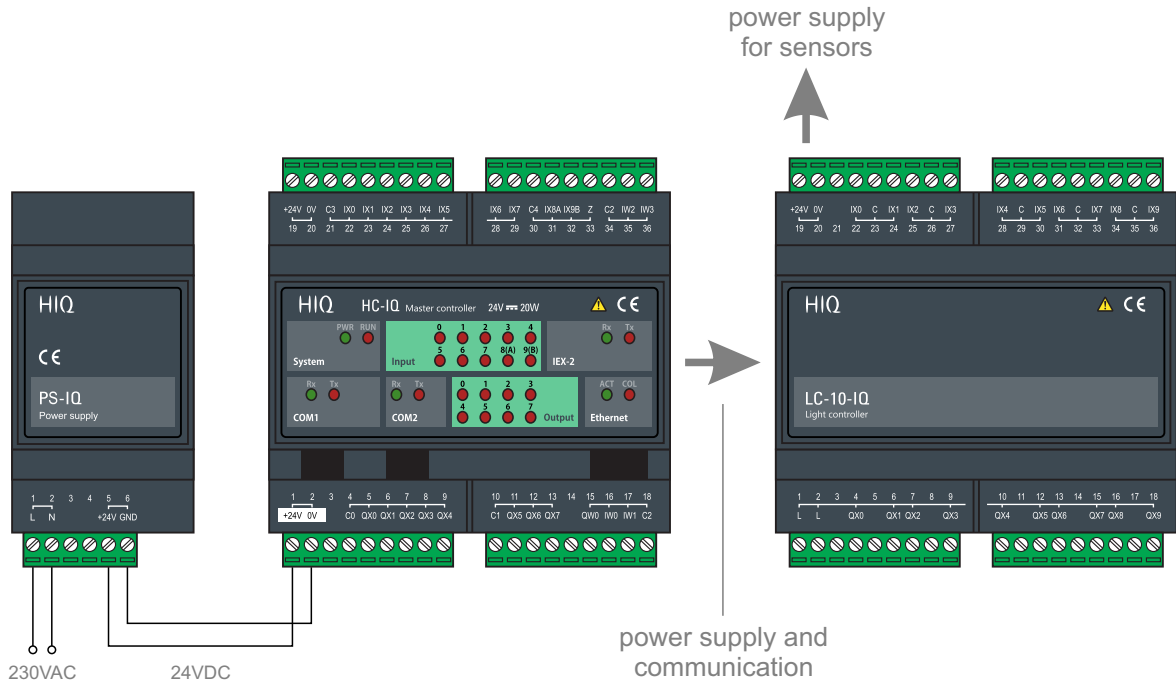

## Backup power

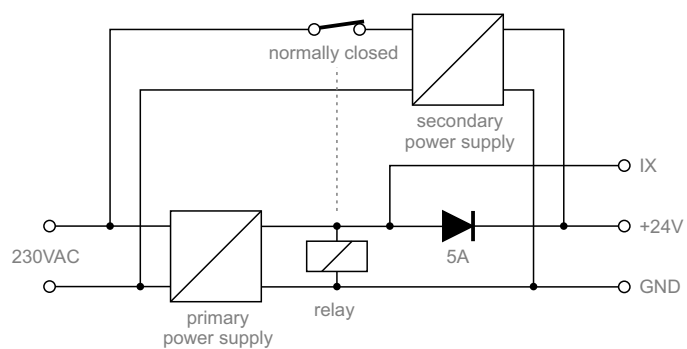

Power supply is usually the most vulnerable part of the system. To prolong service life, secondary power supply may be added. When primary source is broken, the secondary takes on, so the operation is not interrupted. As secondary supply is connected to power only when first breaks, the same service life can be expected as the primary one. A spare input is used as failure indicator.

# LC-10-IQ light controller

10 relay outputs

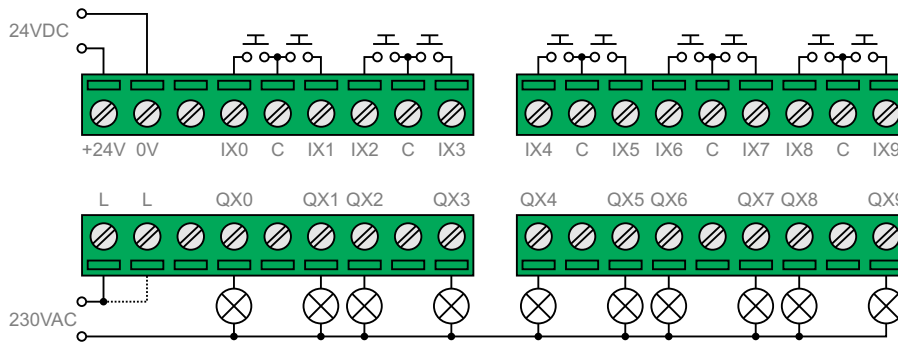

When total output power is 2kW or more, connect mains power supply to both L terminals.



Mounting: 35mm DIN rail 6M

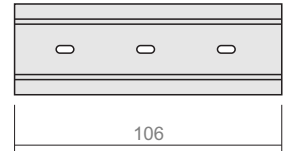

## Output mode

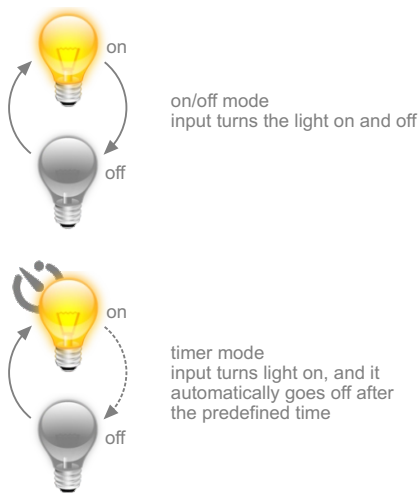

## Features

**8A** output relays are rated 8A, for a more load use external installation relay or contactor



power outage:  
<10min - lights come back  
>10min - lights will stay off

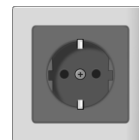

managed socket  
for devices such as floor lamp,  
table fan, dehumidifier, electric  
mosquito repellent, hi-fi system...  
a distinct color is recommended

## Input mode



Input mode defines how input affect the output. Basic functions are handled internally by light controller, night mode and ready light are handled with home controller.

IEX-2 © HIQ □ CE

Output power per relay:  
- incandescent / halogen 230V 800W  
- halogen 12V with transformer 400W  
- fluorescent with electronic ballast 400W  
- parallel compensated fluo lamps 250W/30uF  
- LED with transformer or compact 400W  
Total output power (all relays): 4000W  
Maximum input cable length: 50m  
Power supply: 24V/120mA  
Ingress protection: IP20  
Operating temperature: 0..45°C  
Storage temperature: -20..75°C  
Relative humidity: 0..95% n/c  
Dimensions: 106x108x58mm  
Weight: 250g  
Standards: EN 61000-6-2  
EN 61000-6-3  
EN 60730-1

# LD-V4-IQ LED dimmer

4-channel constant voltage dimmer for LED stripes

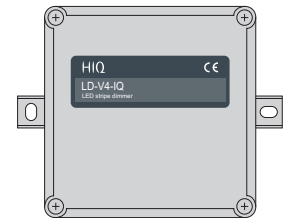

Mounting in-field, junction box or drywall

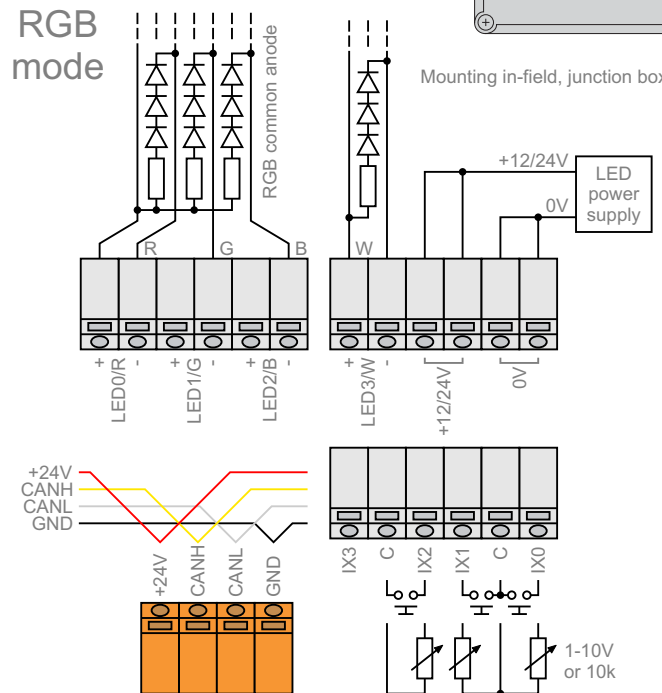
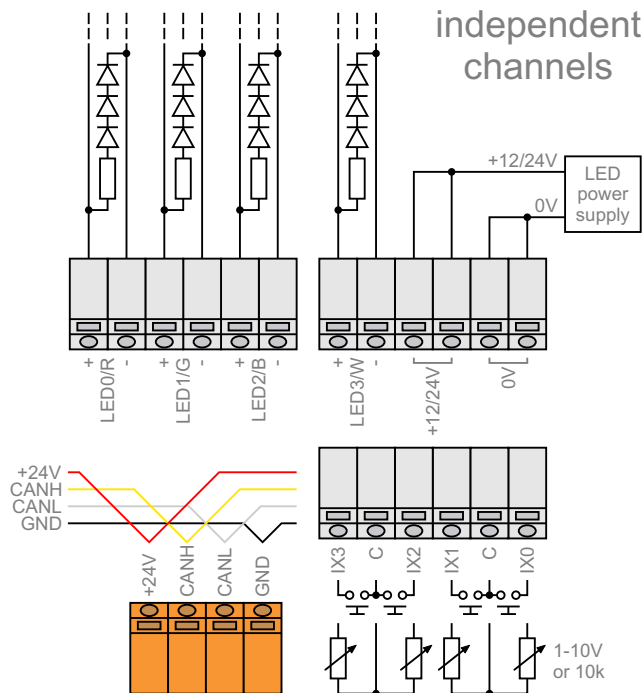

## Features

 RGB mode  
hue, saturation, brightness instead of individual RGB

 white temperature mode  
adjust hue in range from warm white to cold white

button or potentiometer input:  
- autodetect input mode  
- mixed controls possible  
- potentiometer auto-range



S-shaped on/off curve:  
- soft start and landing  
- fast and slow mode  
- reduce electric noise

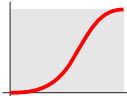

exponential output curve:  
- natural feeling  
- lowest level is 0.025%  
- smooth transition

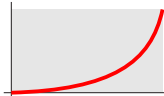

**500Hz**

high frequency PWM:  
- no flickering  
- avoid headache  
- reduce eye-strain

output protection:  
- overcurrent  
- overvoltage  
- undervoltage  
- watch-dog



power outage:  
<10min - lights come back  
>10min - lights will stay off

maximum current	
output	supply
1x10A	1x10A
2x10A	2x10A
3x6.7A	2x10A
4x5A	2x10A

## Operation

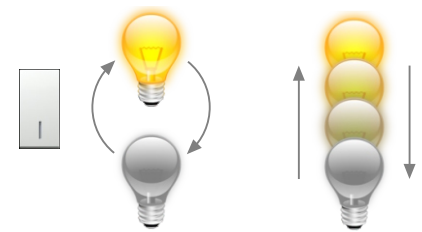

short press: on/off

long press: 0..100%

IEX-2 © HIQ 

LED power supply: 12/24V (10..28V)  
Total output power: 240W at 12V  
480W at 24V  
10A  
Max current per terminal:  
PWM frequency: 500Hz  
Output resolution: 12-bit  
Power supply: 24V/25mA  
Galvanic separation: supply/outputs  
Operating temperature: 0..45°C  
Storage temperature: -20..75°C  
Relative humidity: 0..95% n/c  
Dimensions: 108x86x46mm  
Weight: 160g  
Standards: EN 61000-6-1  
EN 61000-6-3  
EN 60669



# LD-P4-IQ universal dimmer

4-channel dimmer with a separate power driver

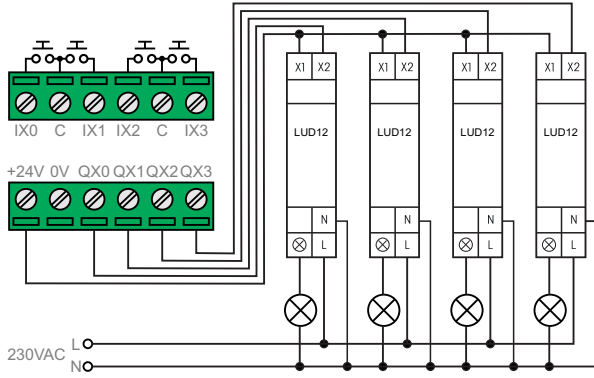
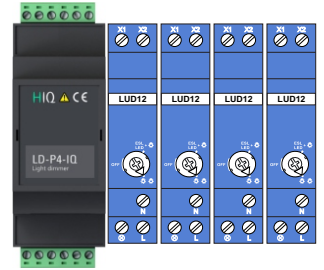

Standard connection with four independent power drivers

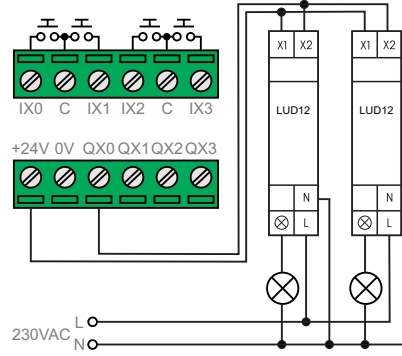

Power increased with a parallel connection of drivers

Mounting: 35mm DIN rail 2M + 4x1M

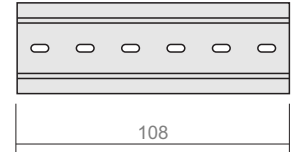

## Features



RGB mode  
hue, saturation, brightness  
instead of individual RGB



white temperature mode  
adjust hue in range from  
warm white to cold white

button or potentiometer input:  
- autodetect input mode  
- mixed controls possible  
- potentiometer auto-range

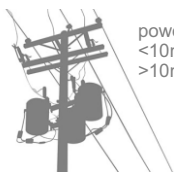

power outage:  
<10min - lights come back  
>10min - lights will stay off



- 400W power MOSFET
- automatic load detection
- low noise zero switching
- electronic overload protection
- overtemperature shutdown

## Operation

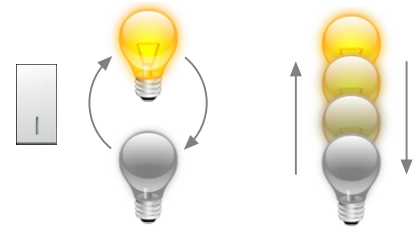

short press: on/off

long press: 0..100%

## Driver rotary switch

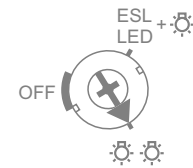

switch must  
be adjusted  
to indicated  
position

## Output options



incandescent/halogen



compact fluorescent



compact LED E27/E14

IEX-2 © HIQ □ CE

Lamp power supply:	230V
Output power per driver:	100W
Drivers per output channel:	unlimited
Driver control signal:	PWM 100Hz 24V
Power supply:	24V/25mA
Galvanic separation:	supply/outputs
Operating temperature:	0..45°C
Storage temperature:	-20..75°C
Relative humidity:	0..95% n/c
Dimensions:	36x108x58mm
Weight:	80g
Standards:	EN 61000-6-1 EN 61000-6-3 EN 60669

# LD-D8-IQ DALI dimmer

8-channel dimmer for DALI ballasts

## Features

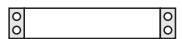
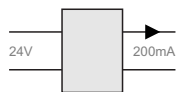
- 8x  control 8 independent groups
- 64x  drive up to 64 ballasts
-  internal DALI current source, no additional power needed

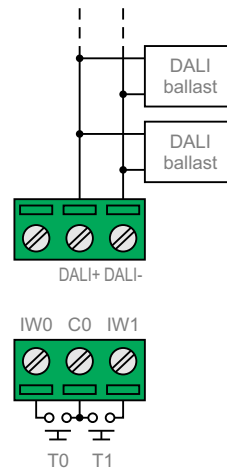

Mounting:  
DIN rail 2M

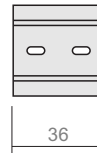

## Operation

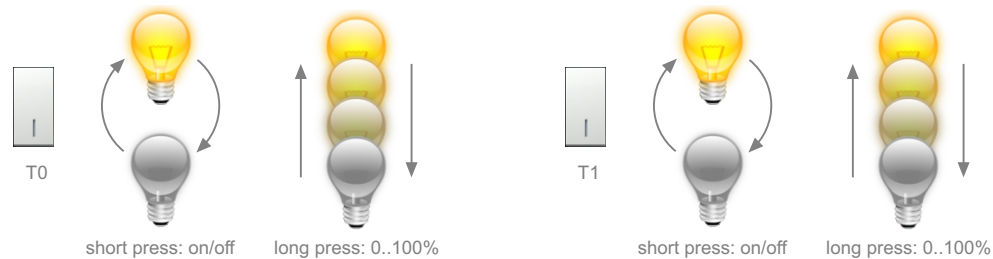

Groups 3 to 8 doesn't have physical input, so they can't be controlled directly, only as a scene or with a phone.

## Ballast configuration



Organize your ballasts into groups with address 1 to 8. DALI dimmer master can't control individual ballasts.

## Output options



## IEX-2 © HIQ □ CE

- |                        |                              |
|------------------------|------------------------------|
| Digital inputs:        | internal pull-up 12V, 2mA    |
| DALI output:           | 64 ballasts/200mA max.       |
| Power supply:          | 24V/120mA                    |
| Galvanic separation:   | none (DALI must be SELV)     |
| Ingress protection:    | IP20                         |
| Operating temperature: | 0..45°C                      |
| Storage temperature:   | -20..75°C                    |
| Relative humidity:     | 0..95% n/c                   |
| Dimensions:            | 36x108x58mm                  |
| Weight:                | 80g                          |
| Standards:             | EN 61000-6-2<br>EN 61000-6-3 |

# BC-5-IQ blinds controller

5-channel blinds position controller

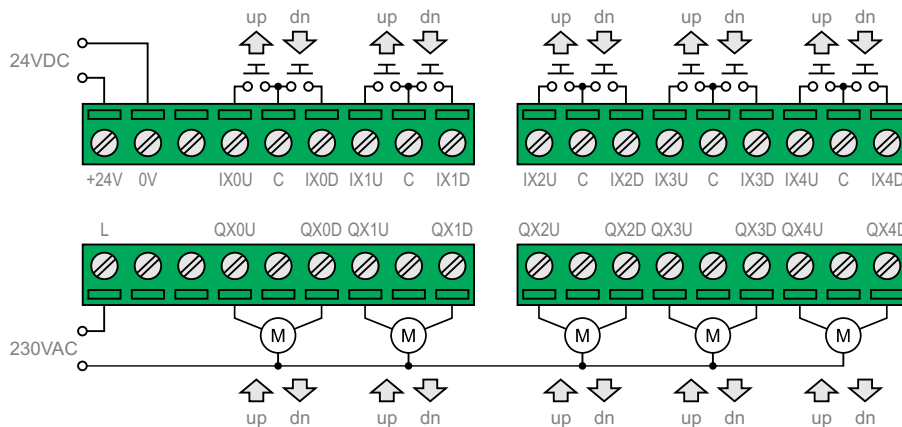

Mounting: 35mm DIN rail 6M

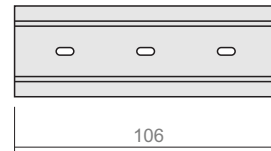

## Features

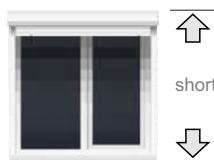

short press: move up/down

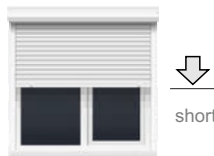

short press while moving: stop at the position

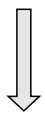

long press: stop after released



short press: move to intermediate position



automatic position related to scene



up and down button



automatic correction at boundary position

Travel time adjustment:

1. Adjust top and bottom limit switch.
2. Use stopwatch to measure travel time in both directions.
3. Mark a position on the window (e.g. 75%), then move blinds a few times up and down, without reaching the top or bottom. If the desired position shifts up, increase down time (or decrease up time) and check again. Repeat procedure until the positioning is precise enough.

IEX-2 © HIQ □ CE

Output power per relay:	200W
Total output power (all relays):	2000W
Maximum input cable length:	50m
Power supply:	24V/60mA
Ingress protection:	IP20
Operating temperature:	0..45°C
Storage temperature:	-20..75°C
Relative humidity:	0..95% n/c
Dimensions:	106x108x58mm
Weight:	250g
Standards:	EN 61000-6-2 EN 61000-6-3 EN 60730-1

# SC-4-IQ scene controller

4-button universal scene controller



## SC-4T-IQ

- 4 configurable touch buttons
- IR receiver + haptic feedback

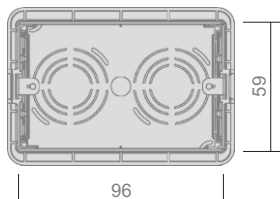
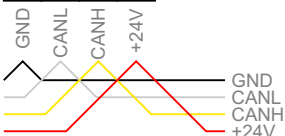
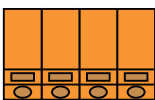

mounting: rectangular box 3M

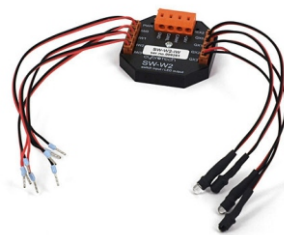
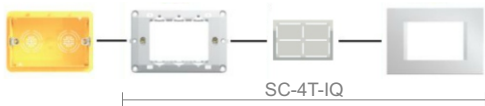

## SC-4S-IQ

- 4 button inputs and 4 LED indicators
- connect to any classic button system
- extra-small size fits into any mounting

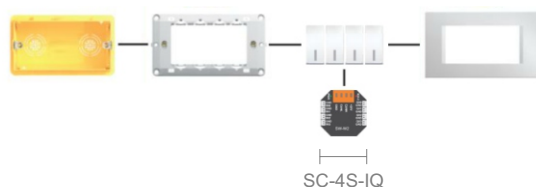
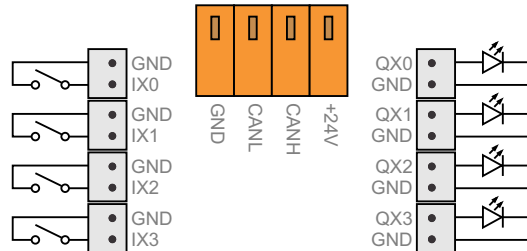

### Panel layout (SC-4T-IQ)

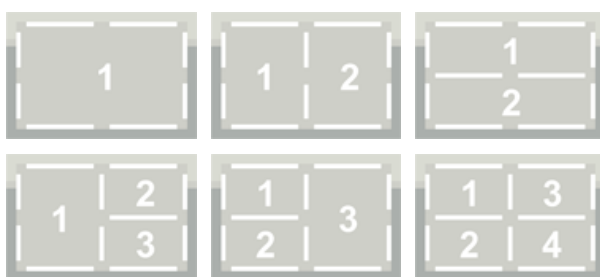

### Button action



### Inverse scene



second press force all lights to off, blinds are not changed

### Memorize scene



long press, confirmed by beep, store current state as a new scene

### Remote controller

- 0** set scene 0 (code 1152)
- 1** set scene 1 (code 1153)
- 2** set scene 2 (code 1154)
- ...
- 9** set scene 9 (code 1161)
- ...
- set scene 10 (code 1162)
- ...
- set scene 31 (code 1183)

## IEX-2 © HIQ □ CE

- IR remote receiver: RC5 36kHz
- Power supply: 24V/25mA (SC-4T)  
24V/35mA (SC-4S)
- Ingress protection: IP20
- Operating temperature: 0..45°C
- Storage temperature: -20..75°C
- Relative humidity: 0..95% n/c
- Mounting: rectangular box 3M (SC-4T)  
any installation box (SC-4S)
- Dimensions: 122x80x23mm (SC-4T)  
49x49x7mm (SC-4S)
- Weight: 80g (SC-4T)  
20g (SC-4S)
- Standards: EN 61000-6-2  
EN 61000-6-3

# TH-1-IQ thermostat

simple electronic thermostat

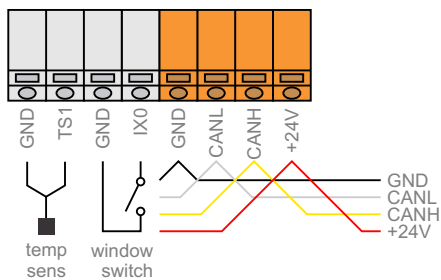

**TH-1M-IQ**  
mechanic buttons









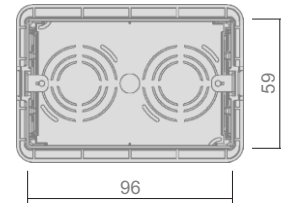

**TH-1T-IQ**  
touch buttons







Mounting: rectangular box 3M



## Features

-  on/off
-  setpoint
-  fan control
-  fan max  
maximum output for a limited time
-  secondary setpoint when thermostat is off
-  manual measurement correction
-  window switch  
shut down heating when window is open
-  night mode  
attenuate display during the night

## Fan options

-  fan speed 0 or 1
-  fan speed 0, 1 or 2
-  fan speed 0, 1, 2 or 3
-  maximum output for a limited time

## Display when on

-  measured temperature
-  setpoint temperature
-  fan speed

## Display when off

-  off
-  dashes
-  temperature

## Temperature sensor



Remote measurement should be handled by plc program

## IEX-2 © HIQ □ CE

Window switch input:	internal pull-up 12V, 2mA
Temperature measurement:	internal and external
Measurement range:	0..45°C
Default offset:	-2.5°C
Power supply:	24V/15mA
Ingress protection:	IP20
Operating temperature:	0..45°C
Storage temperature:	-20..75°C
Relative humidity:	0..95% n/c
Mounting:	rectangular flush box
Dimensions:	122x80x23mm
Weight:	80g
Standards:	EN 61000-6-2 EN 61000-6-3

# TH-2-IQ thermostat

blind electronic thermostat



Mounting: on wall

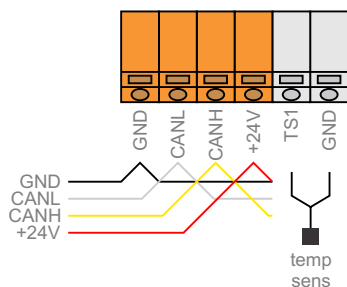

## Signalisation

- device not addressed
- device selected
- setpoint change up
- setpoint change down

## Features

- on/off
- setpoint
- fan control
- fan max  
maximum output for a limited time
- precise temperature measurement
- manual measurement correction
- secondary setpoint when thermostat is off
- humidity meter

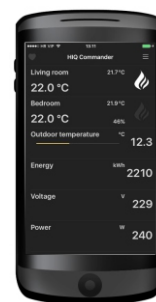

all functions handled by a mobile phone

## Temperature sensor



Remote measurement should be handled by plc program

## IEX-2 © HIQ □ CE

Temperature measurement:	internal and external
Temperature range:	0..45°C
Default offset:	-1.4°C
Humidity range:	0..100%rh
Power supply:	24V/10mA
Ingress protection:	IP20
Operating temperature:	0..45°C
Storage temperature:	-20..75°C
Relative humidity:	0..95% n/c
Mounting:	wall surface
Dimensions:	71x71x27mm
Weight:	50g
Standards:	EN 61000-6-2 EN 61000-6-3

# TH-3-IQ thermostat

thermostat with display and configurable buttons

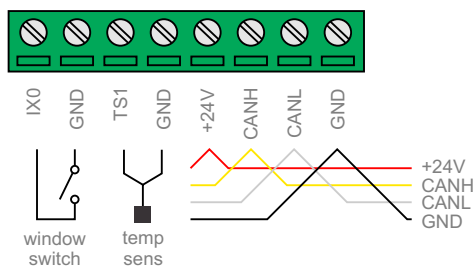
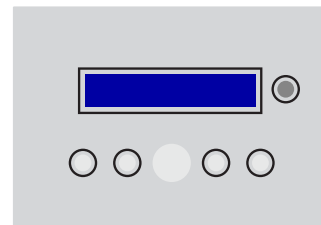

Mounting: regular 60mm junction box



## Features

- on/off
- setpoint
- fan control
- fan max  
maximum output for a limited time
- secondary setpoint when thermostat is off
- manual measurement correction
- window switch  
shut down heating when window is open
- night mode  
attenuate display during the night
- humidity meter

## Configuration

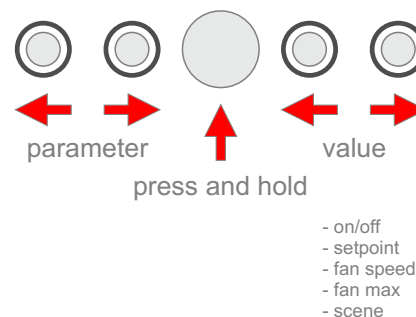

## Features

- massive aluminium body
- glass power plate
- white blue alphanumeric display
- mechanical buttons with a click
- button function fully configurable
- IR receiver

## Temperature sensor



Remote measurement should be handled by plc program

## IEX-2 © HIQ □ CE

Temperature measurement:	internal and external
Measurement range:	0..45°C
Default offset:	-2.0°C
Power supply:	24V/25mA
Ingress protection:	IP20
Operating temperature:	0..45°C
Storage temperature:	-20..75°C
Relative humidity:	0..95% n/c
Mounting:	wall surface
Dimensions:	136x96x36mm
Weight:	450g
Standards:	EN 61000-6-2 EN 61000-6-3

# FC-1-IQ fan-coil actuator

3-speed fan coil actuator

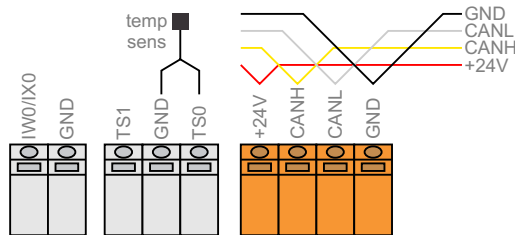
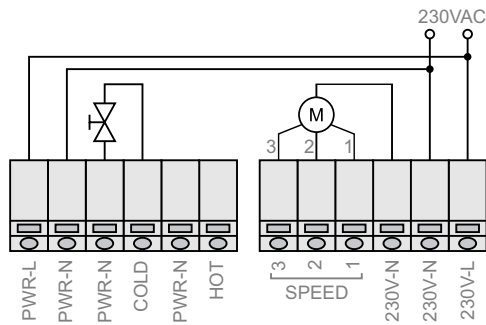
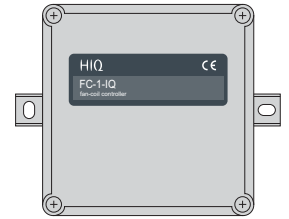

Mounting: inside fan-coil

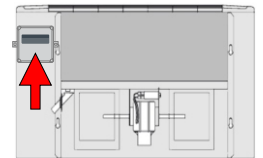

fan coil

- 2-pipe system
- electromechanical valve
- 3-speed fan
- both heating and cooling

## Features

simple  
no adjustments, no jumpers or DIP switches,  
configuration is completely performed on PC

flexible  
can be used with a wide range of  
home, office and industrial convectors

fallback mode  
device continue operation even in  
case that communication is broken

IEX-2 © HIQ  

Relay outputs:	3A/250V
Temperature measurement:	external sensor ES or ES-A
Power supply:	24V/45mA
Operating temperature:	0..45°C
Storage temperature:	-20..75°C
Relative humidity:	0..95% n/c
Mounting:	inside the fan coil unit
Dimensions:	108x86x46mm
Weight:	150g
Standards:	EN 61000-6-2 EN 61000-6-3 EN 60730-1



# SDM-120C power meter

voltage, power, relative power and energy meter

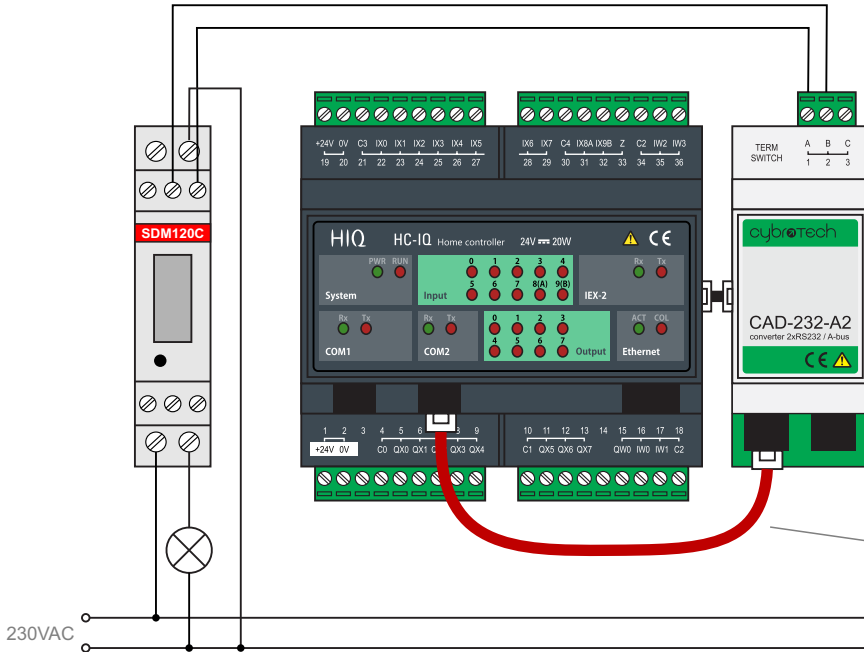
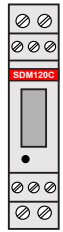

Mounting: 35mm DIN rail 1M + 2M



SDM120C

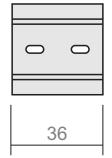

CAD-232-A2

Note: CAD-232-P0 communication cable is delivered together with converter.

SDM-120C  
power meter

CAD-232-A2  
RS232/485 converter

## IEX-2 © HIQ □ CE

Nominal voltage:	230VAC, 110VAC
Voltage range:	77..300VAC
Maximum current:	45A
Operational frequency:	50..60Hz
Power consumption:	2W
Communication setup:	2400 8e1
Modbus address:	1
Communication cable:	CAD-232-P0
Ingress protection:	IP51
Operating temperature:	-25..55°C
Storage temperature:	-30..70°C
Relative humidity:	85%
Mounting:	DIN rail
Dimensions:	119x17.5x62mm
Weight:	85g
Standards:	IEC 62053-21

# IR-580-IQ and other sensors

motion sensor, door sensor, light sensor



## Motion sensor

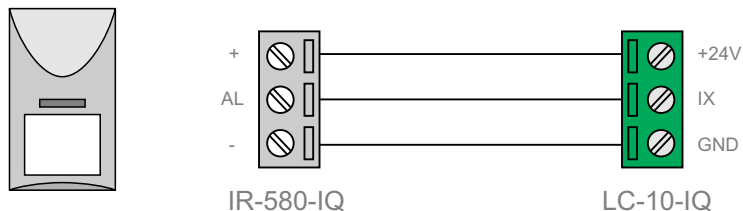

Motion sensor is mounted above or lateral to room entrance. People entering the room must intersect sensor beams. At the moment when closing the door, person should be in the area of maximum sensitivity.

## Door sensor



Door sensor is mounted on the knob side, usually about 20cm from the top. Magnet goes into the door, contact goes into the doorpost.

Sensors are connected to spare LC-10-IQ inputs. Input type must be configured as sensor input.

## Light sensor

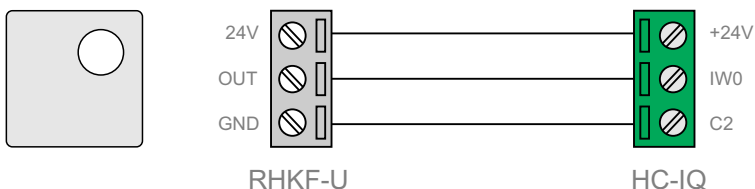

Light sensor is mounted on top of an outside looking window. Best option is west or south side.

For a room with more than one entrance, door sensors are connected in series (sensor is closed when door is closed), and motion sensors are connected in parallel.

## Mounting

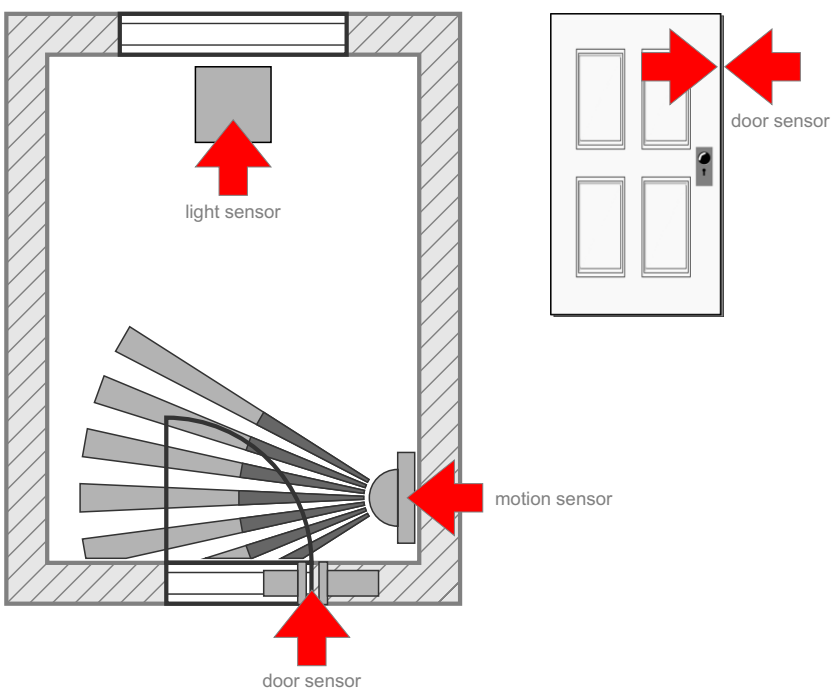

## IEX-2 © HIQ □ CE

Door sensor	-
Switch type:	reed switch, normally open
Dimensions:	25x7mm
Weight:	12g
Motion sensor	
Output type:	NPN o.c. 75mA
Power supply:	24V 10mA
Operating temperature:	20..50°C
Storage temperature:	-20..75°C
Dimensions:	100x60x42mm
Weight:	85g
Light sensor	
Output type:	0..10V
Power supply:	24V 80mA
Operating temperature:	0..50°C
Storage temperature:	-20..75°C
Dimensions:	85x85x27mm
Weight:	65g

# AS-24RA touchless switch

no-contact wall mounting switch

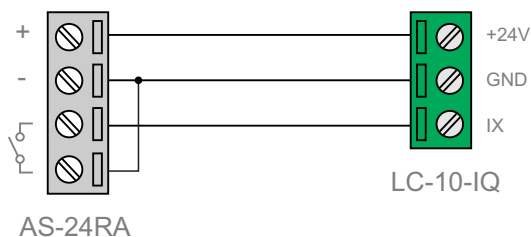

Mounting: regular 68mm junction box

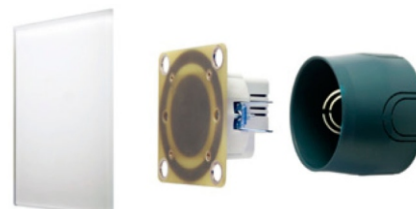

## Operation

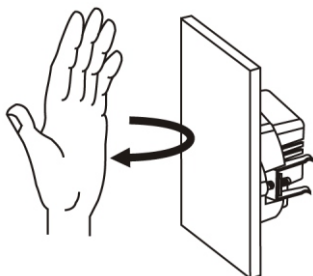

## Features

- reliable way to detect a hand through most materials
- countless decorative switchplates
- switchplates attach via magnets and are easily exchanged
- range adjusted with potentiometer
- low power consumption
- excellent noise immunity

## Drawing

### Dimensions

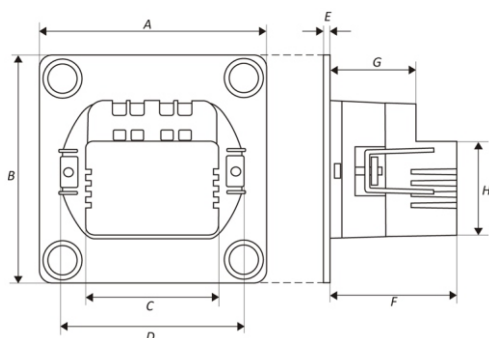

A (width)	70mm
B (height)	70mm
C (back housing width)	40mm
D (back housing width)	59mm
E (plate thickness)	1.6mm
F (depth)	34.4mm
G (depth)	25.5mm
H (back housing height)	28.5mm

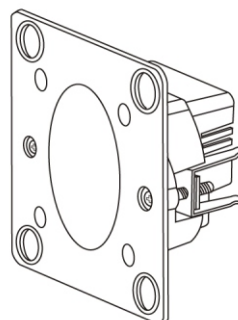

IEX-2 © HIQ □ CE

Switch model:	AS-24RA
Detection distance:	2..10cm adjustable
Detection delay:	200ms
Output type:	NPN o.c. momentary
Power supply:	24V 6mA
Operating temperature:	0..50°C
Storage temperature:	-20..75°C
Weight:	85g

# Wiring

## Switchboard and field modules

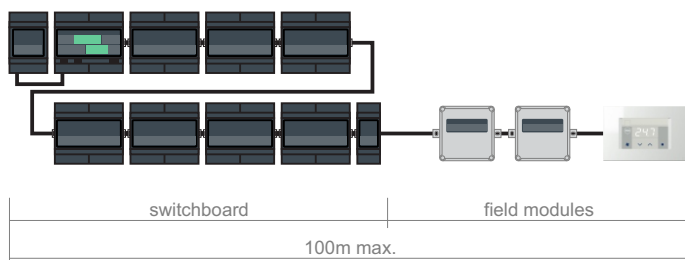

Power supply must be connected to the first (leftmost) device. When devices are connected, autoaddress procedure must be started using HIQ Configurator.

Devices inside switchboard are addressed sequentially, from left to right. Devices outside of switchboard (field modules) are addressed in order of ascending serial numbers - lowest serial number gets the first address, second lowest the second, and so on.

Inside the switchboard, bus is connected with 4x flat cable and RJ9 connectors. Outside the switchboard, bus is connected with a unshielded twisted-pair cable and orange push-wire terminals.

Maximum bus length is 100 meters. Up to that length, bus can be connected with no special rules, branching is allowed. Longer bus (up to 300m) is possible, but cable must be connected in line (no branches/trunks), and last device must be terminated with a 120ohm resistor between CANL and CANH.

### Recommended bus cable

unshielded twisted pair 2x2 0.5mm<sup>2</sup>

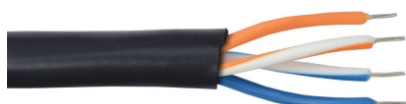

### Wire stripping

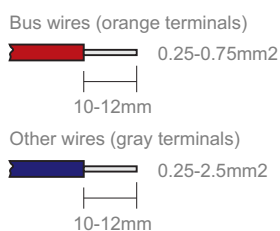

### Push-wire handling

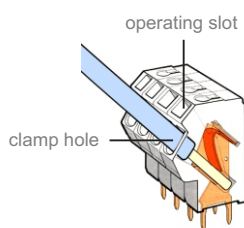

#### Solid wire insertion

1. Push wire in the clamp hole

#### Stranded wire insertion

1. Push screwdriver in the operating slot
2. Insert wire in the clamp hole

#### Solid/stranded wire removal

1. Push screwdriver in the operating slot
2. Remove wire

## Bus wiring

1. Take one ingoing and one outgoing wire together, and remove insulation for about 10-12mm.

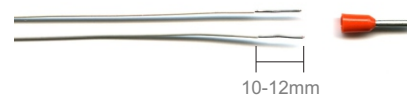

2. Crimp wires together into a ferrule.



3. Wrap wires together for a few centimeters.

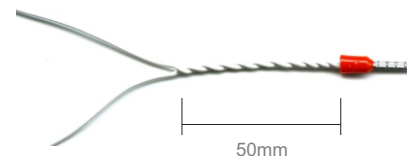

4. Push ferrules into clamps.

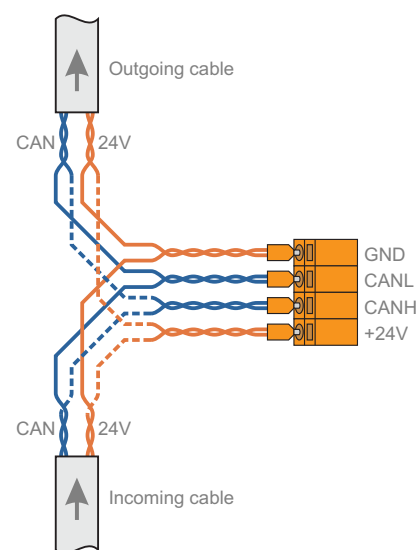

### Wire type



# Switch panel

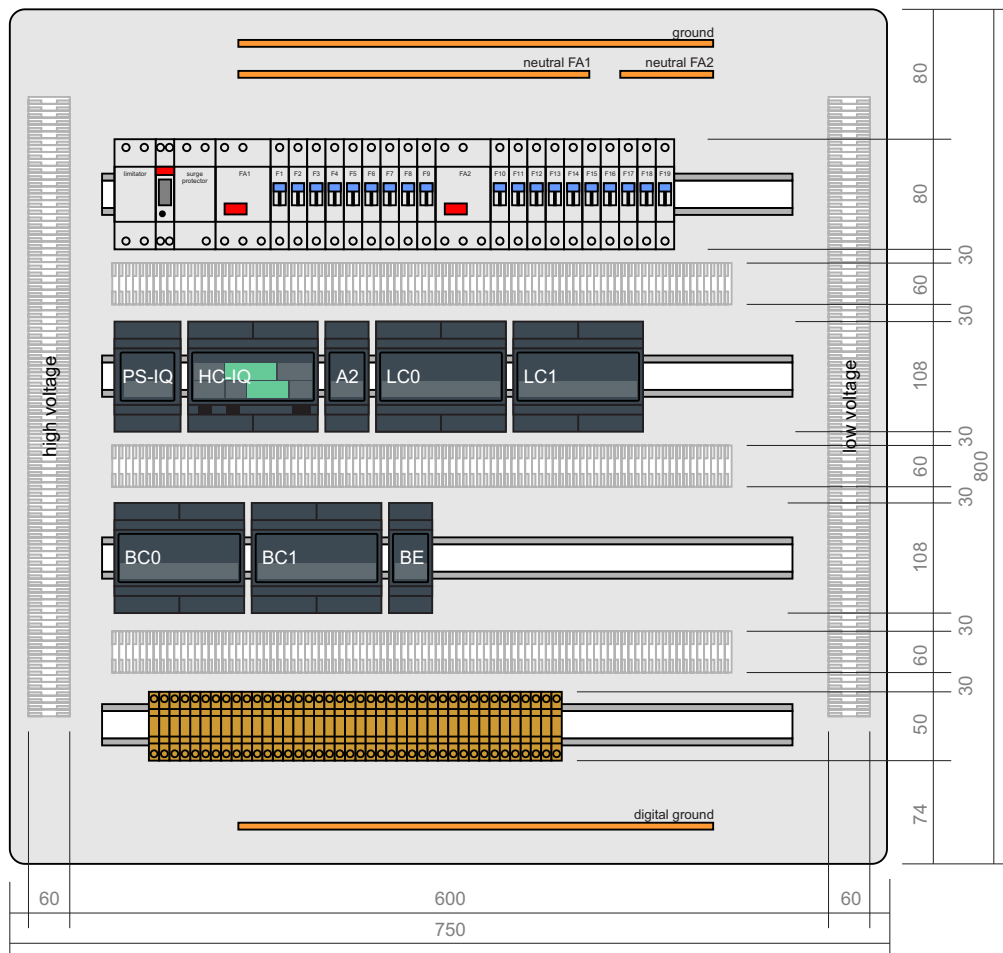

## Schematic diagram

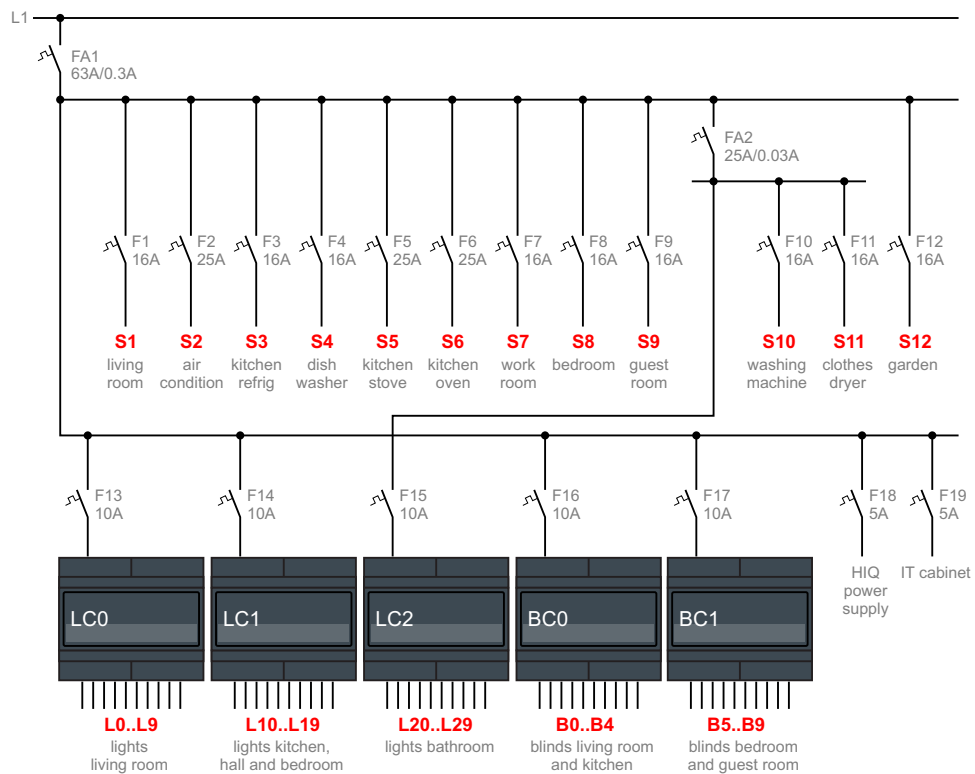

# Dimensions

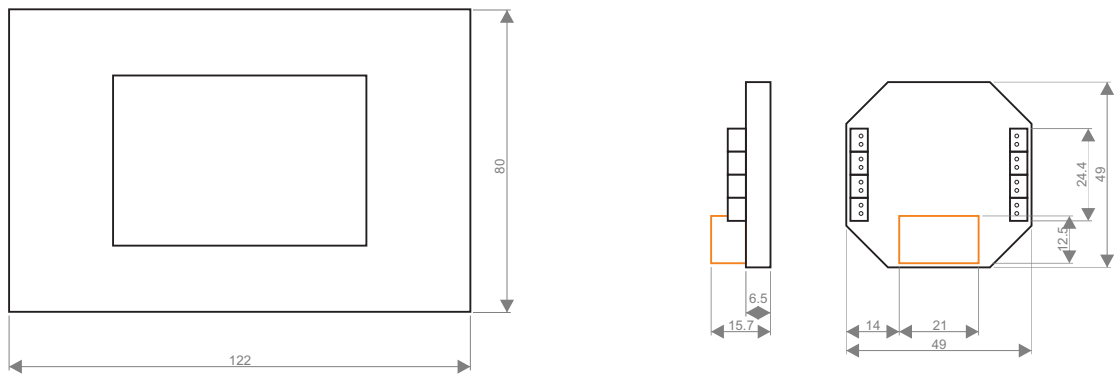
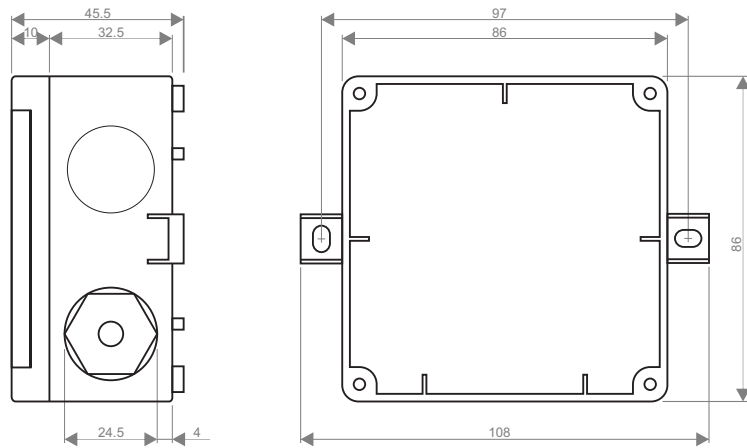
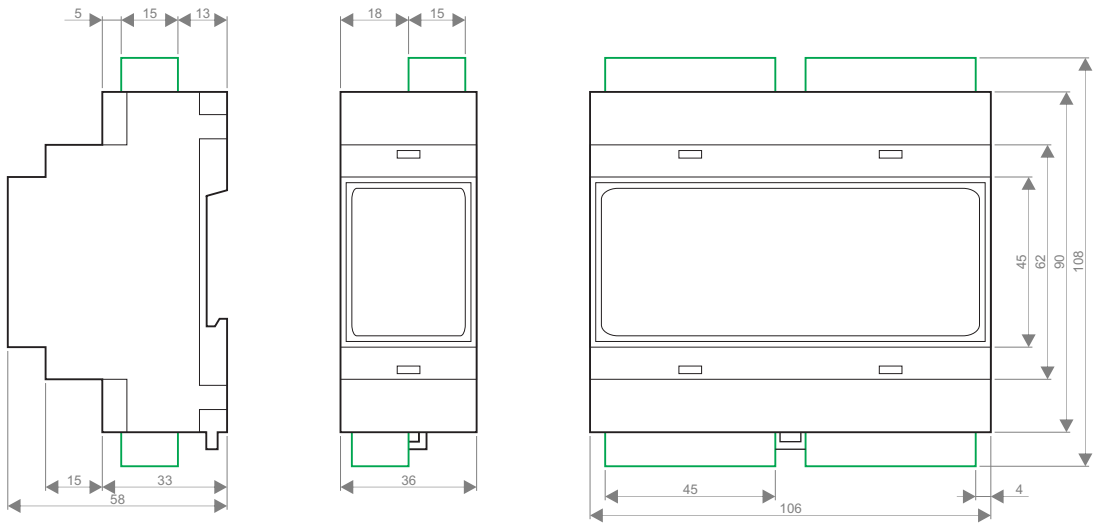

# Order code

devices and sensors



LC-10-IQ  
light controller  
with 10 outputs



LD-P4-IQ  
4-channel  
universal dimmer  
LUD-12  
power driver

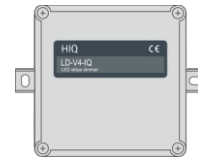

LD-V4-IQ  
4-channel  
LED strip  
dimmer



BC-5-IQ  
5-channel  
blinds controller



LD-D8-IQ  
8-channel  
DALI dimmer



SC-4T-IQ  
touch screen  
scene controller



SC-4S-IQ  
scene controller for  
standard buttons



TH-1T-IQ  
thermostat with  
touch buttons



TH-2-IQ  
blind thermostat



TH-1M-IQ  
thermostat with  
mechanical buttons

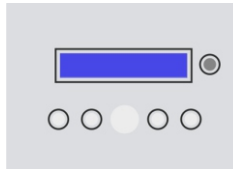

TH-3-IQ  
thermostat with  
scene buttons



FC-1-IQ  
fan-coil  
actuator



HC-IQ  
master controller



PS-IQ  
power supply 24V



BE-PROT  
bus adapter +  
surge protector



IR-580-IQ  
motion sensor



REED-SW  
door sensor



RHKF-U  
light sensor

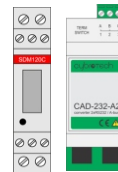

SDM120C  
power meter  
CAD-232-A2  
232/485 converter  
(including cable)

# Order code

cables and accessories



RE-2  
IR remote controller



ES  
temperature sensor



ES-A  
temperature sensor



CAD-P0  
bus cable 2.5cm, RJ9/RJ9  
connecting devices in switchboard



CAD-2-BUT  
2x mini-button



CAD-P2  
bus cable 2m, RJ9/RJ9  
connecting rows in switch panel



CAD-232-P0  
cable for 232/485 converter



OL30-PW  
3M decorative cover



SM11-PW-NT  
push button 1M



NM30  
mounting frame for  
3M rectangular box



SM41-PW-NT  
push button 1M  
up/down



AS-24RA  
touchless switch