



Firmware update

CyBroBinLoader software

- Download latest CyBroBinLoader.exe from www.cybrotech.com



	CyBroBinLoader-v3.0.3.exe Update Cybro kernel and plc program. Also able to set alias, model, baudrate, IP address, Modbus id, and dump controller memory. Works in local network, internet connection is not supported.	766.50 KB 2021-07-17	 
---	--	----------------------	--

Applications

- Replacement for RS485 wiring solution with wireless. Optimal for long range Modbus RTU serial communications with half duplex configuration.

</WRAP>

Installation and mounting

-  Carefully open WM-1 module and configure serial communication with jumpers. (Default configuration is 9600bps, 8N1 with normal timeout)
-  Place WM-1 module at least 10cm from other objects. Installation is not recommended inside metal cabinets.
- Connect RS485 terminals to WM-1 RS485 terminals
 - A - A
 - B - B
 - C - GND
- Connect to 230V power supply
- Configure radio pairing

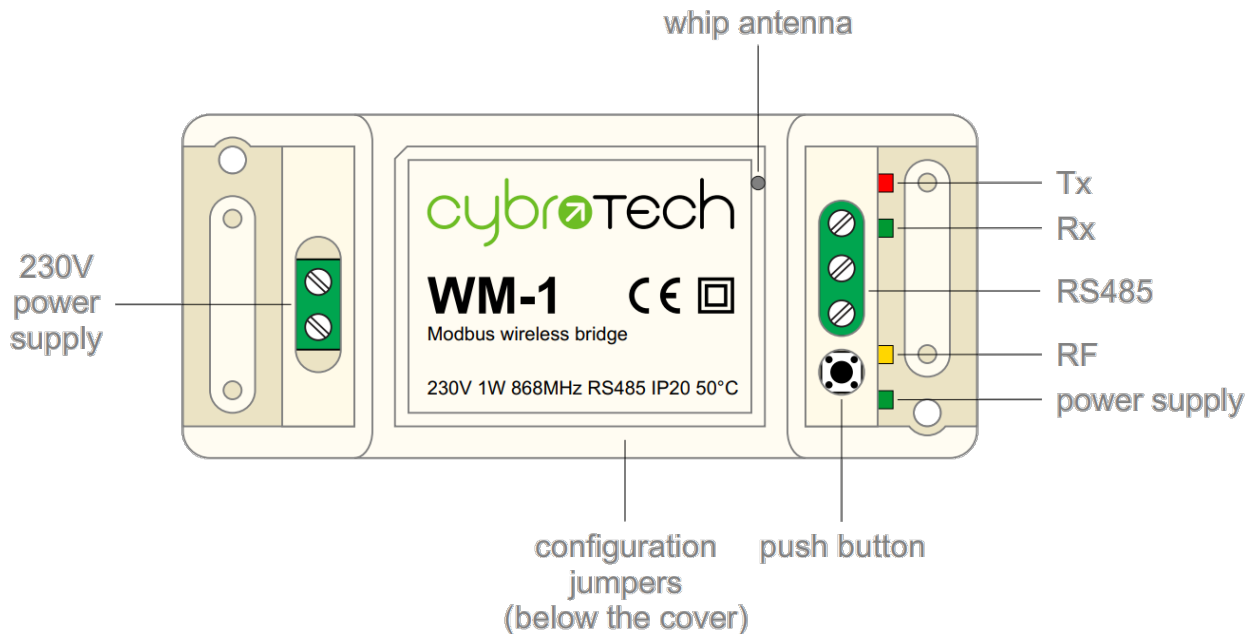

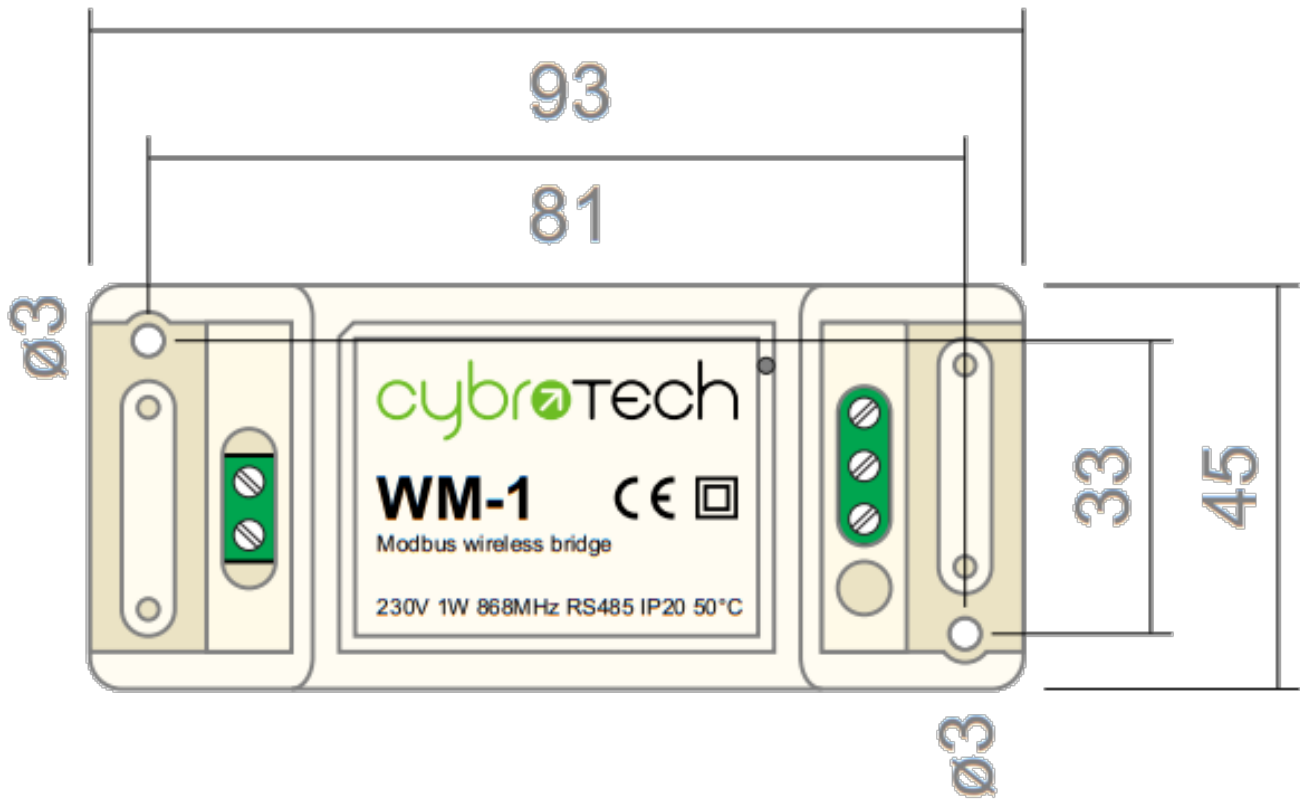

Features

- replacement for RS485 wiring
- Modbus RTU serial protocol
- wired/wireless combinations
- very long range, no hopping
- protected private connection
- multiple slaves per device
- multiple addressable groups

From:

<http://wiki.hiq-universe.com/> -

Permanent link:

http://wiki.hiq-universe.com/doku.php?id=en:hems_v1_2_0:methods_resources:firmwareupdate&rev=1635337321

Last update: **2021/10/27 12:22**

