

HIQ designing

Presented electric wiring plans were made with the help of [Elwin](#) software which is made by [3xM Automation company](#). New plans can be made with modification of included [Elwin project](#) or with modification of [DXF plans](#) with any DXF capable program. With the Elwin project, all HIQ symbols are included. The whole design plan can be also downloaded as a [PDF file](#).

Page 1- Power distribution-RCD switch and power meter

Single phase power input, connection of RCD switch (Residual Current Device) and [power meter](#). Input can be single or three phase.

The [power meter](#) on the wiring plan is connected to measure the whole electricity consumption, but can be connected to any device (or group of devices). Only single phase electricity measurement is available.

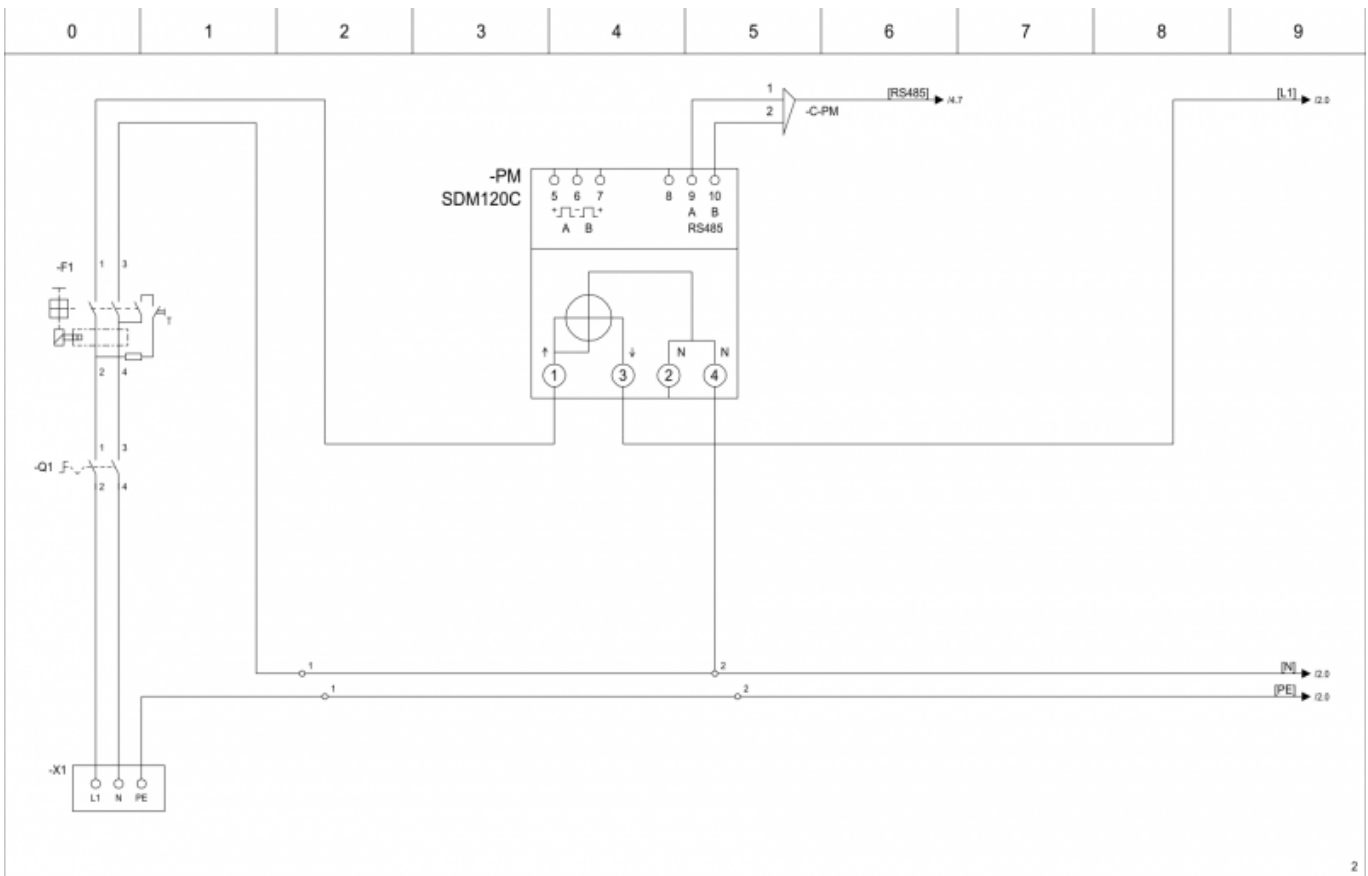

			Last changed by SS Last changed 8/11/2016 Print date 9/11/2016	 Robotina d.o.o. OIC Kozina 38 SI-6240 Kozina	POWER DISTRIBUTION HIQ wiring diagrams	Drawing number 001 Pages 38	Installation = Location + Page number 1
--	--	--	---	--	---	--	---

Page 2-3 - Power distribution - Fuses

Suggested fuse plan.

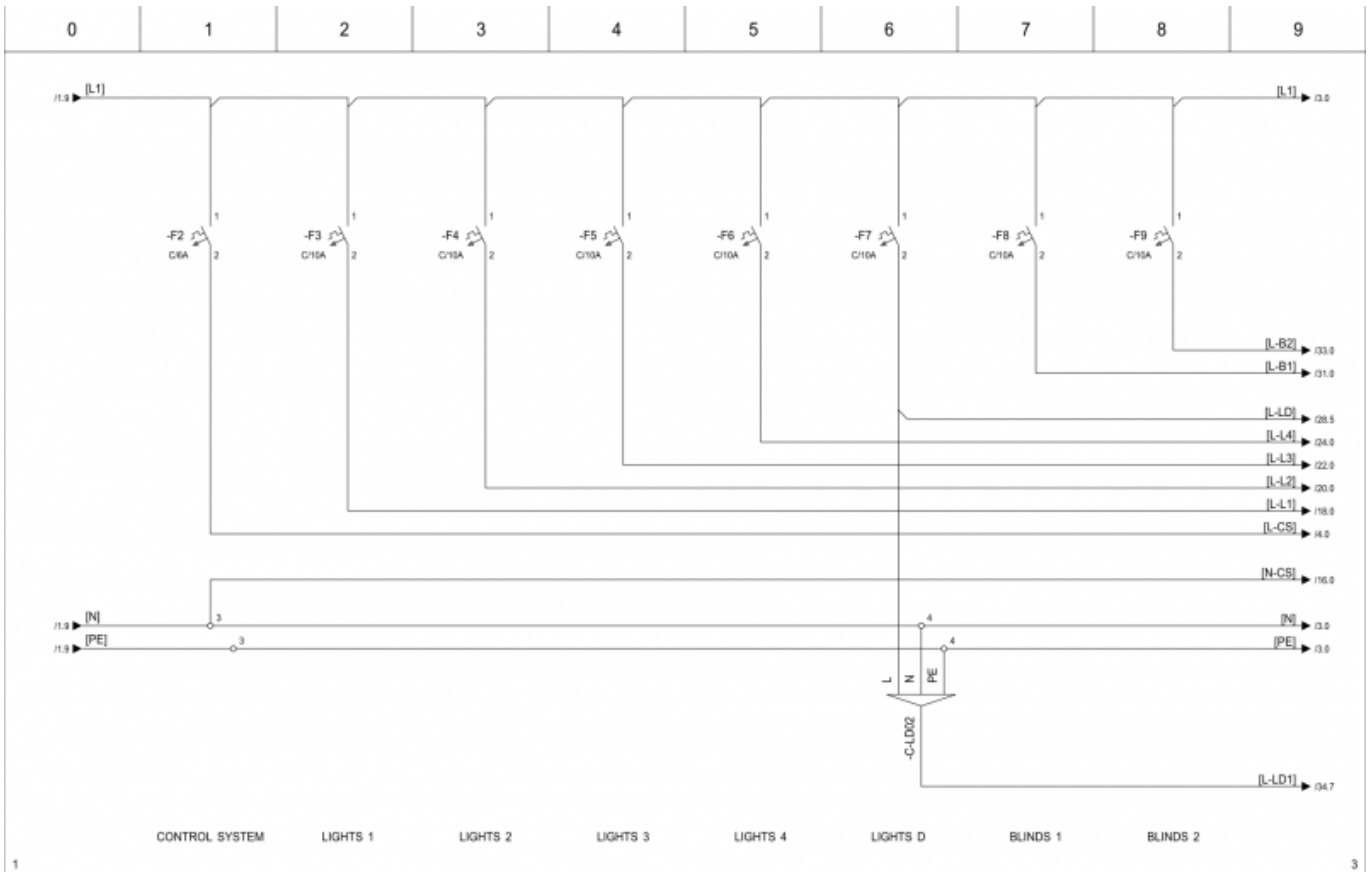

			Last changed by SS Last changed 7/11/2016 Print date 9/11/2016	Robotina d.o.o. OIC Kozina 38 SI-6240 Kozina	POWER DISTRIBUTION HIQ wiring diagrams	Drawing number 001	Installation =
Rev 1	Revision text	Signature	Date			Pages 38	Location +

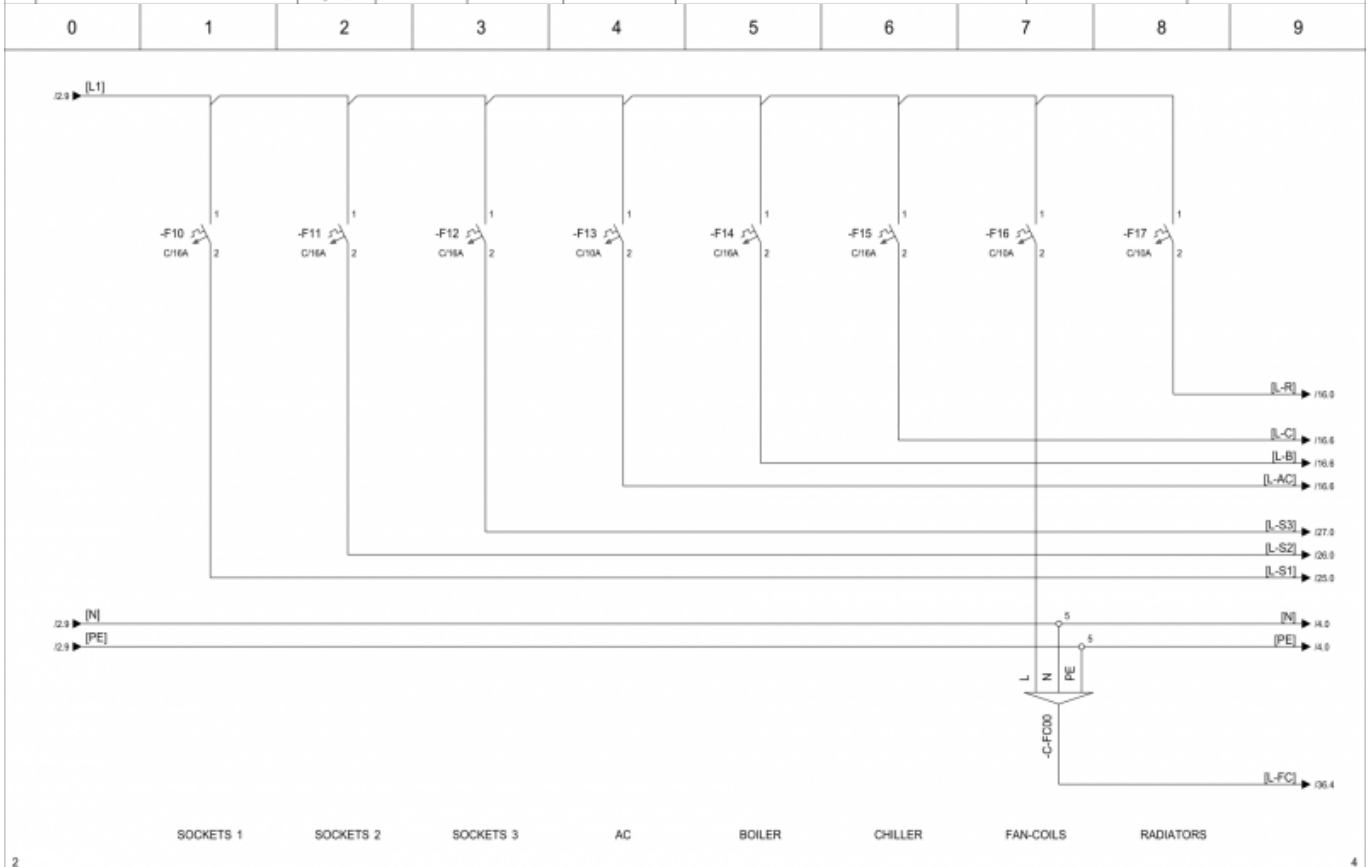

			Last changed by GK Last changed 2/11/2016 Print date 9/11/2016	Robotina d.o.o. OIC Kozina 38 SI-6240 Kozina	POWER DISTRIBUTION HIQ wiring diagrams	Drawing number 001	Installation =
Rev 1	Revision text	Signature	Date			Pages 38	Location +

Page 4 - Control System-Power supply, HC, CAD-232

24V power supply (PS) for control system, Home controller and CAD-232-A2-IQ.

24V power supply can be optionally used for LED lighting (up to 2.5A with serial power supply, larger power supply can be used).

Home controller (HC) is the heart of the system. It is connected to the network (ETH) and has optional inputs (connections are on page 15) and outputs (connections are on page 16).

CAD-232-A2-IQ expander is used as communication interface between home controller and power meter (If power meter is not used then the expander is not necessary). It is connected to a home controller through IEX bus, to COM2 on home controller input and to power meter (RS485 communication).

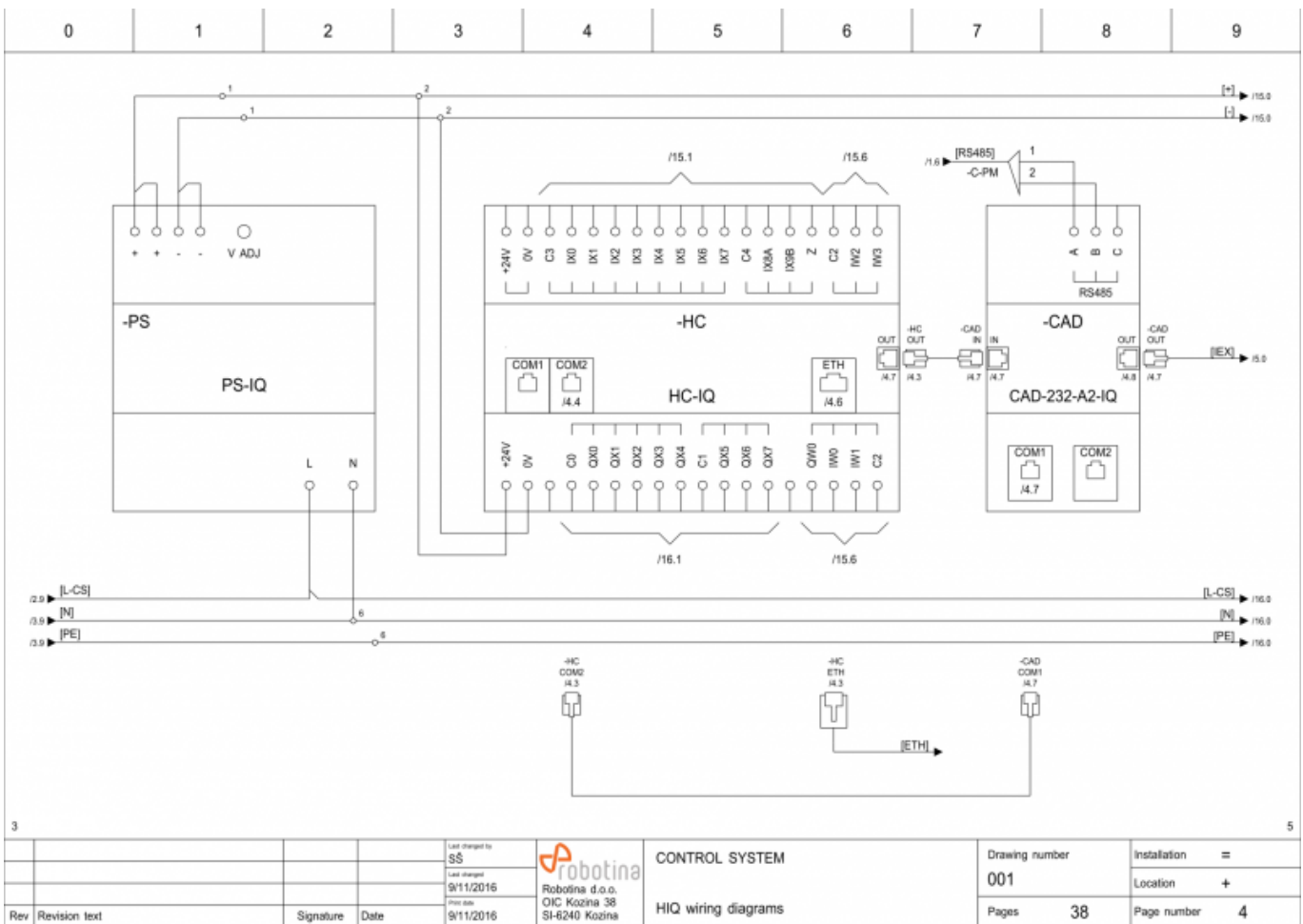

Page 5-6 - CS-Light controller 00 and 01

Light controllers (LC) are connected to IEX bus, we can connect up to up 4 LC to 1 home controller. On the top side are inputs and on the bottom side are outputs (connections are on page 17-24).

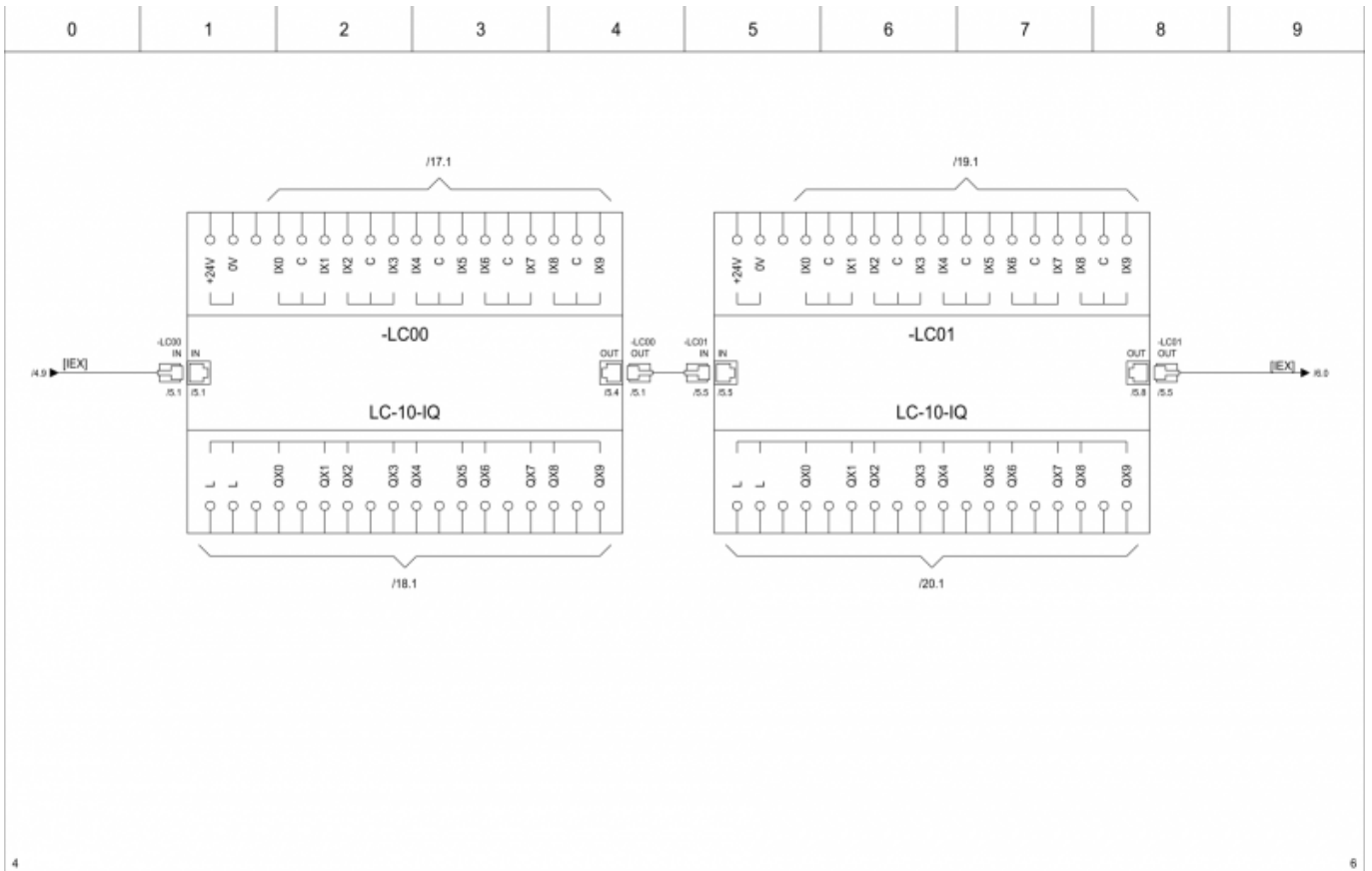

			Last changed by GK Last changed 20/10/2016 Print date 9/11/2016		Robotina d.o.o. OIC Kozina 38 SI-6240 Kozina	CONTROL SYSTEM HIQ wiring diagrams			Drawing number 001 Pages 38		Installation = Location + Page number 5	
Rev	Revision text	Signature	Date									

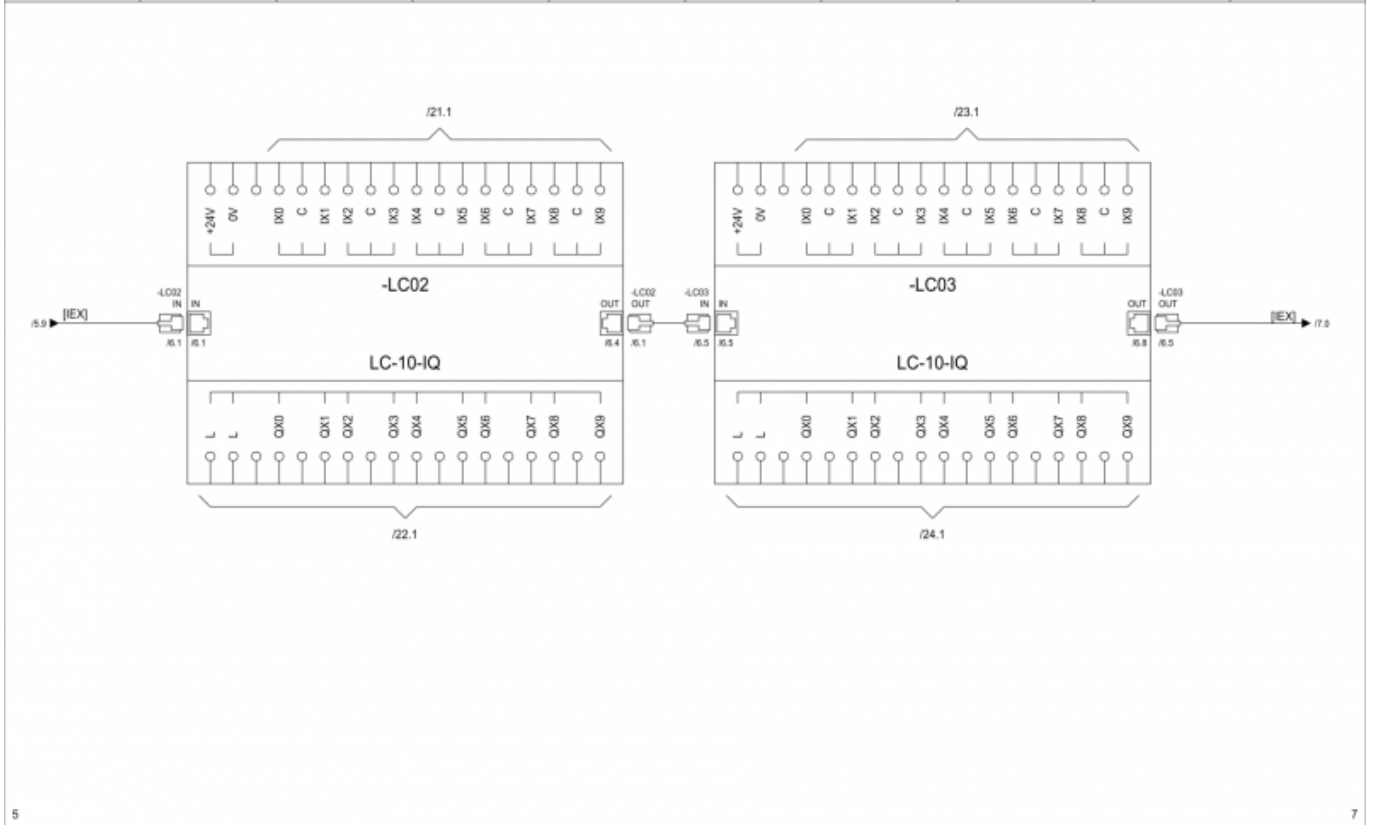

			Last changed by GK Last changed 20/10/2016 Print date 9/11/2016		Robotina d.o.o. OIC Kozina 38 SI-6240 Kozina	CONTROL SYSTEM HIQ wiring diagrams			Drawing number 001 Pages 38		Installation = Location + Page number 6	
Rev	Revision text	Signature	Date									

Page 7 - CS - Light dimmer

Up to 4 light dimmers can be connected to 1 HC. On sample plan we use 2 [Light dimmers drivers](#) for LUD-12 universal light dimmers.

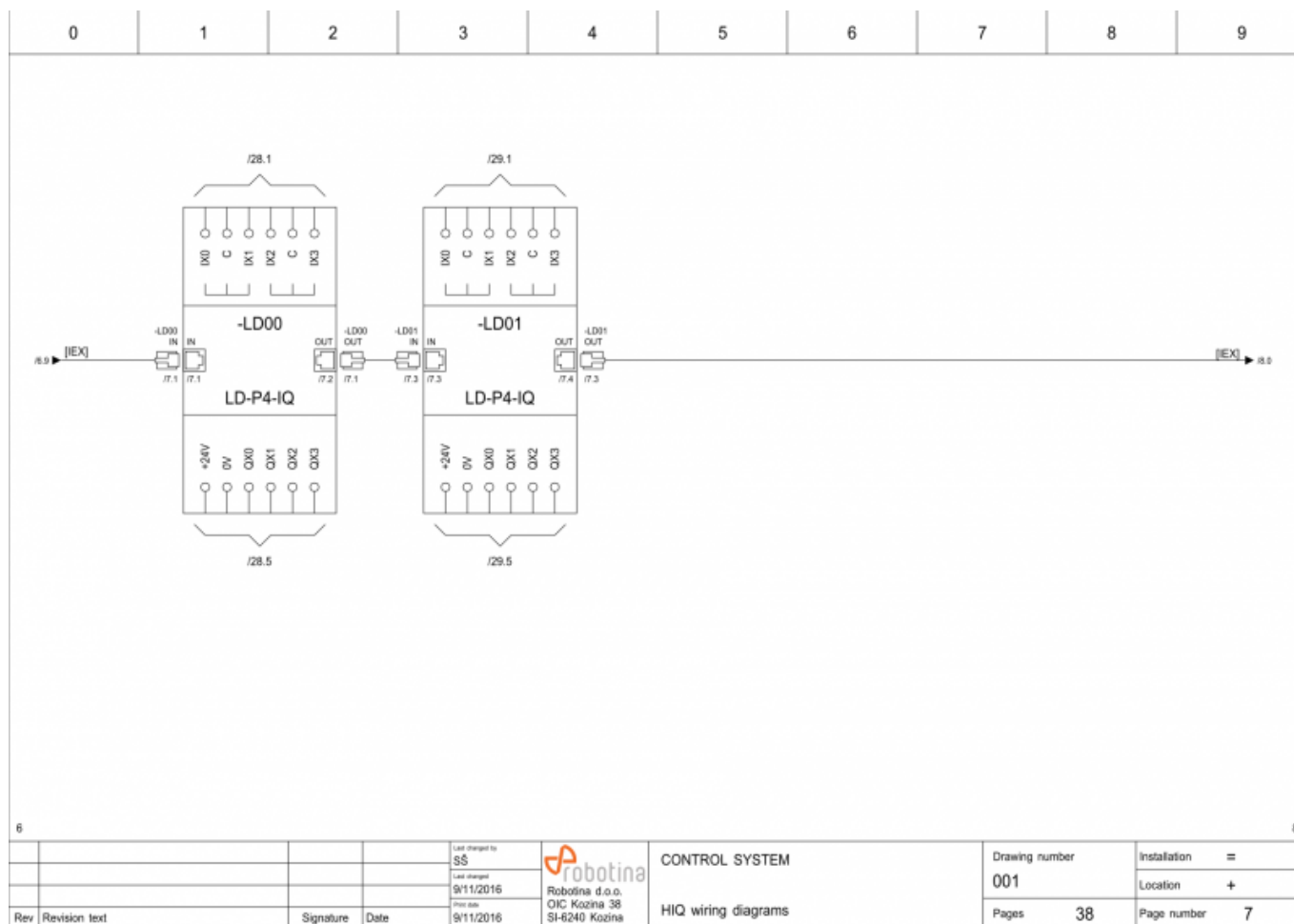

Page 8 - CS - Blinds controllers

Up to 2 [Blinds controllers \(BC\)](#) can be connected to 1 HC.

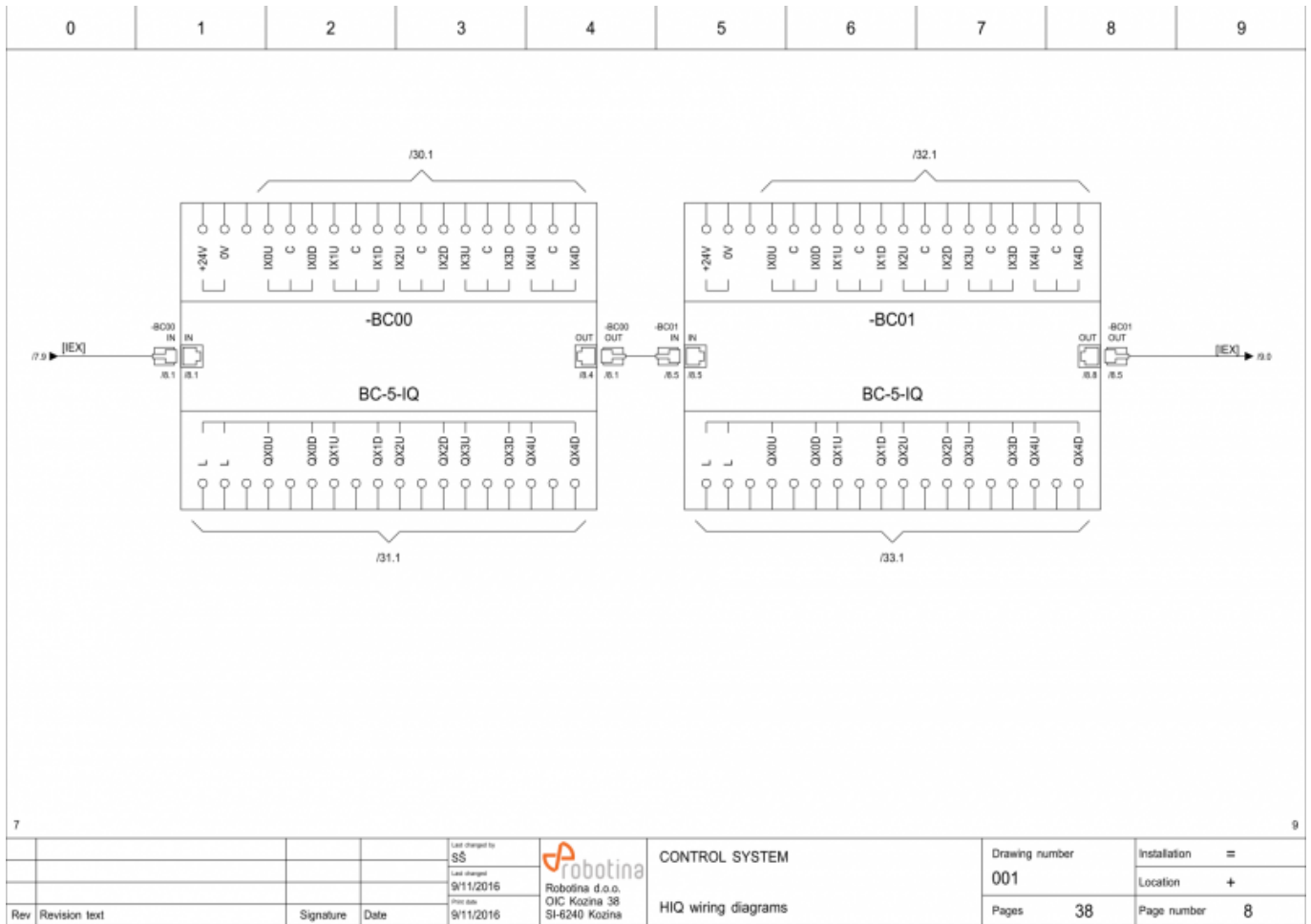

Page 9 - CS - bus extender, LED light dimmer

Bus extender (BE) is a passive switch for easy IEX bus interconnection between cabinet and field modules.

Up to 4 light dimmers can be connected to 1 HC. On sample plan we use 2 LED stripe dimmers.

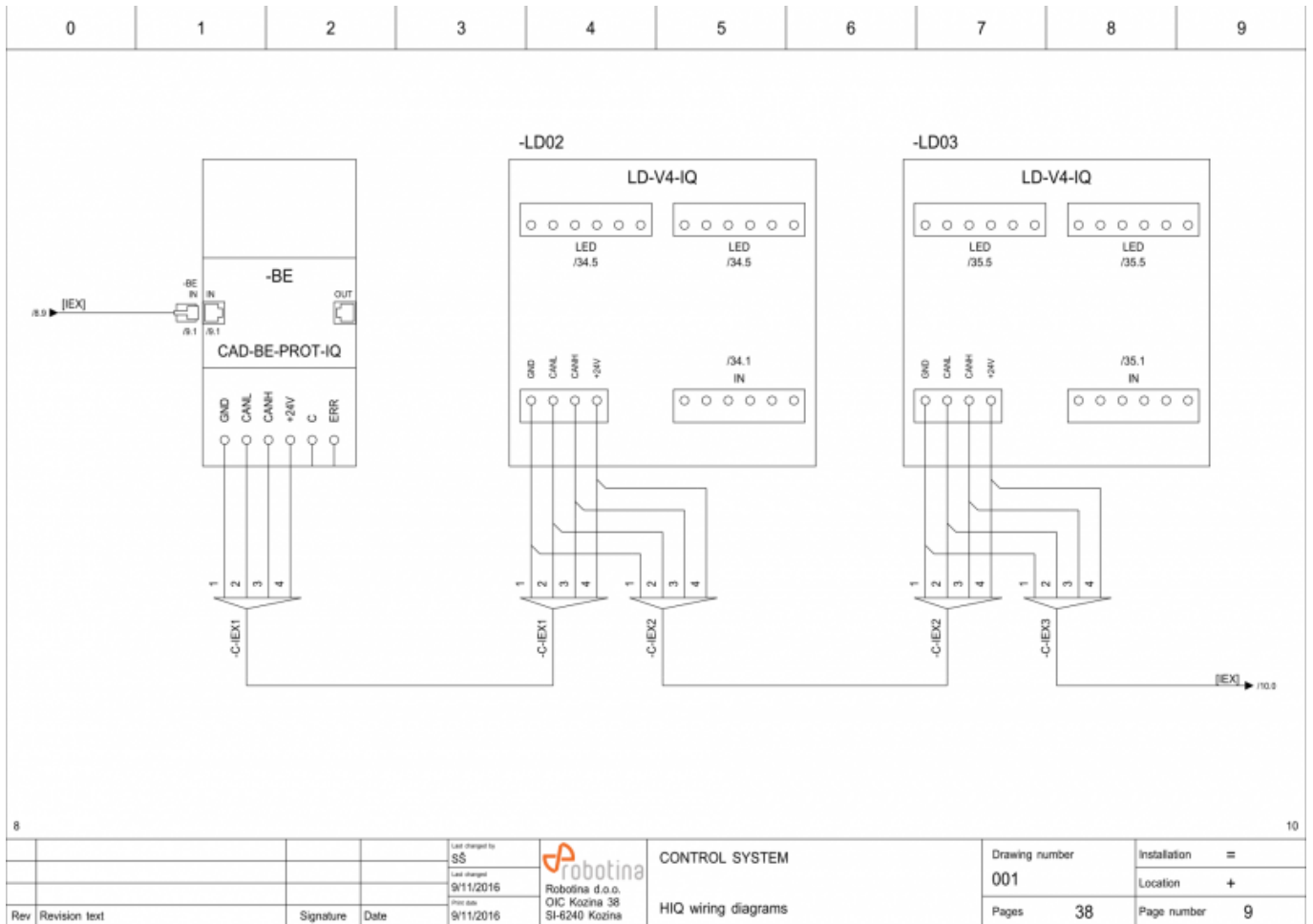

Page 10 - CS - Scene controllers

Up to 4 Scene Controllers can be connected to 1 HC. On sample plan are 4 [Scene Touch Panels](#), but also [Scene Panels](#) and [Scene controllers](#) can be connected in the same way.

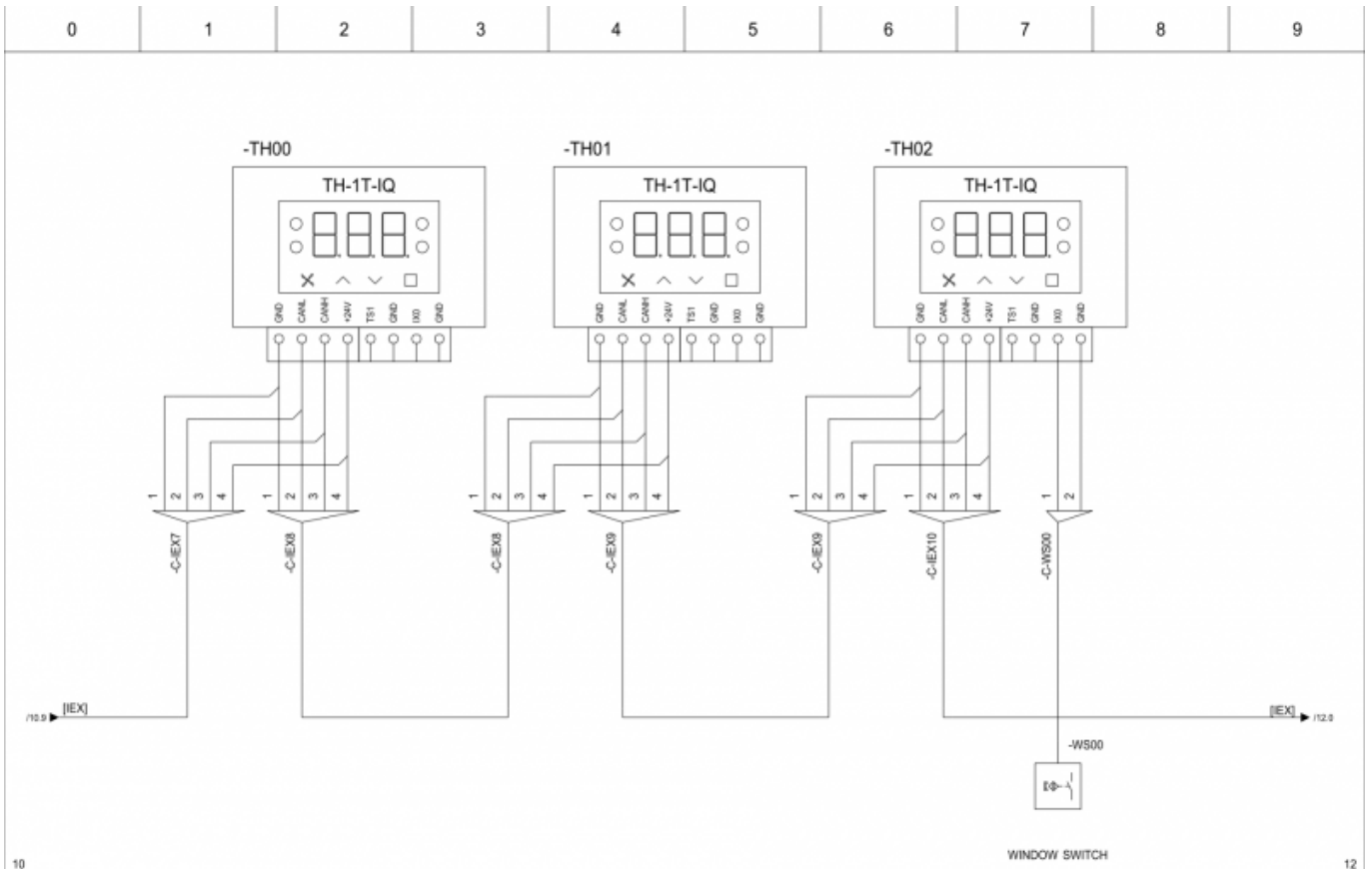

			Last changed by SS Last changed 8/11/2016 Drawn by 8/11/2016	Robotina d.o.o. OIC Kozina 38 SI-6240 Kozina	CONTROL SYSTEM	Drawing number 001	Installation = Location +
Rev	Revision text	Signature	Date		8/11/2016	HIQ wiring diagrams	Pages 38

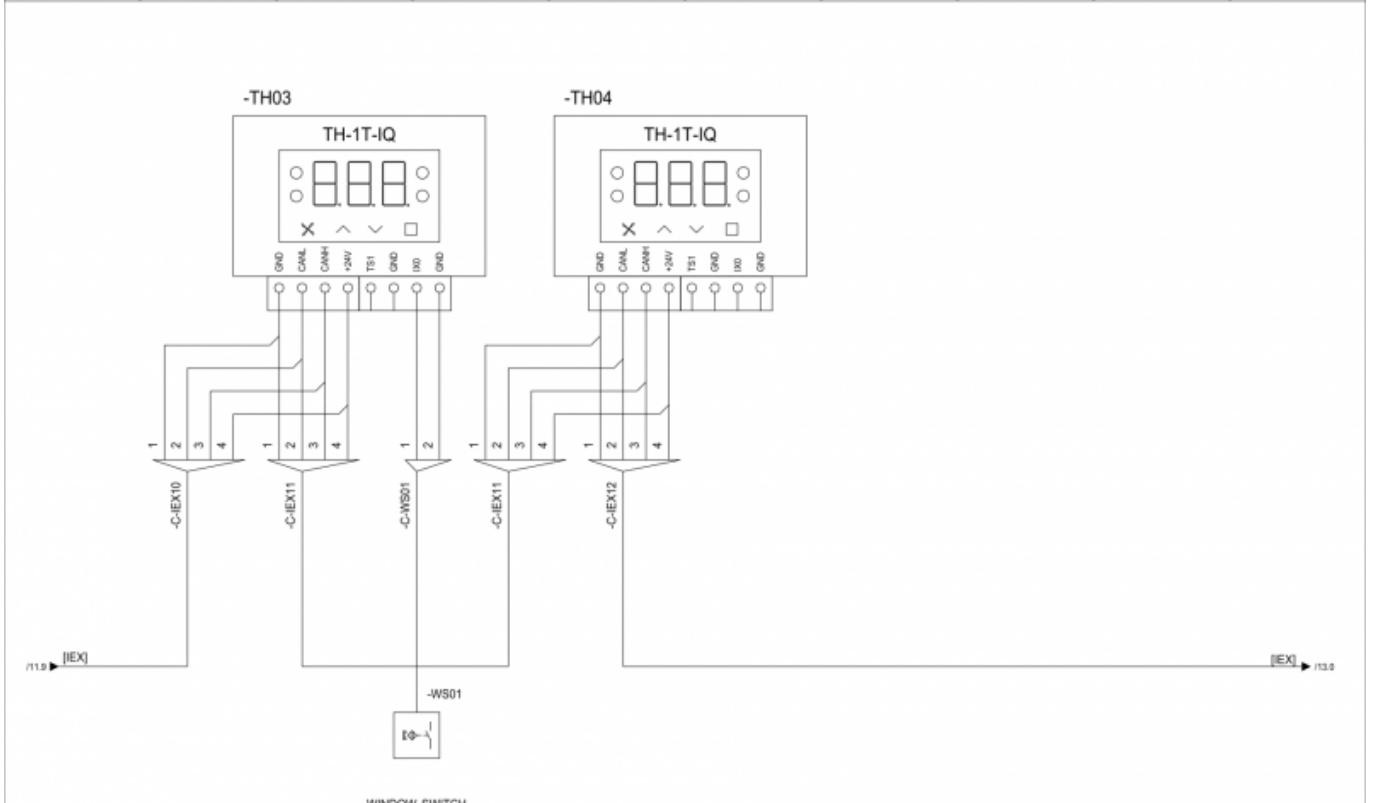

			Last changed by SS Last changed 8/11/2016 Drawn by 8/11/2016	Robotina d.o.o. OIC Kozina 38 SI-6240 Kozina	CONTROL SYSTEM	Drawing number 001	Installation = Location +
Rev	Revision text	Signature	Date		8/11/2016	HIQ wiring diagrams	Pages 38

Page 13 - CS-Fan-coil

Up to 5 Fan-coil controllers (FC) can be connected to 1 HC. On our sample plan we have 3 FC, 2 thermostats are controlling radiator valves (page 36-38).

FC controllers are the last items on IEX bus. Longer IEX bus lines (over 100m) must be terminated with a 120ohm resistor between CANL and CANH (-R1).

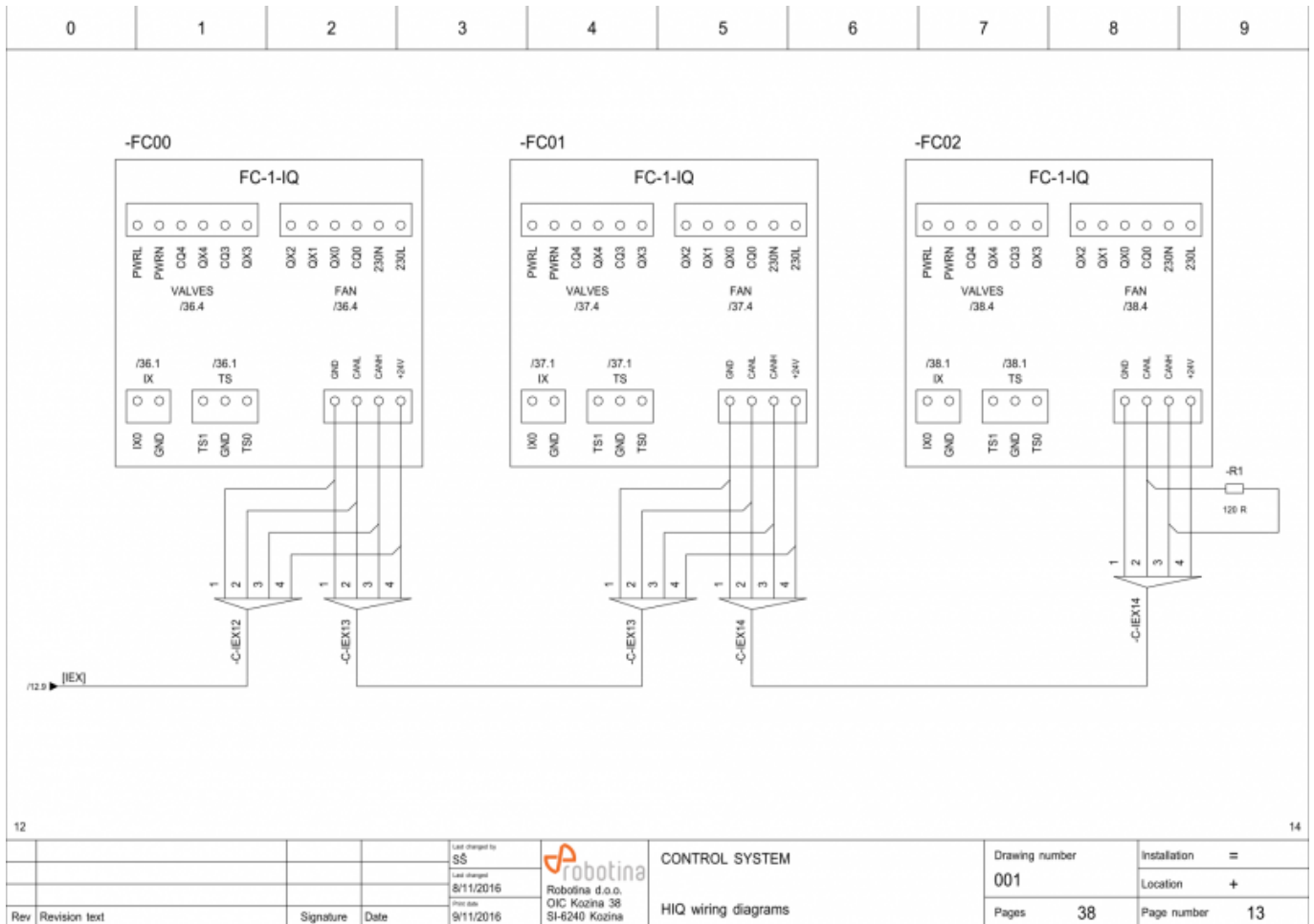

Page 14 - CS-Blank page

Blank page for future extensions.

0 1 2 3 4 5 6 7 8 9

SPARE PAGE -
INTENTIONALLY LEFT BLANK

13

15

				Last changed by GK	 Robotina Robotina d.o.o. OIC Kozina 38 SI-6240 Kozina	CONTROL SYSTEM	Drawing number 001	Installation =
				Last changed 19/8/2016		HIQ wiring diagrams	Location +	
Rev	Revision text	Signature	Date	9/11/2016			Pages 38	Page number 14

Page 15 - Home controller inputs

If used, optional [lightness sensor](#) must be connected to IW0 analog input on [home controller](#).
 All other inputs are left for custom programming solutions (10 digital inputs IX0-IX7, IX8A, IX9B and 3 8-bit analog inputs IW1-IW3).

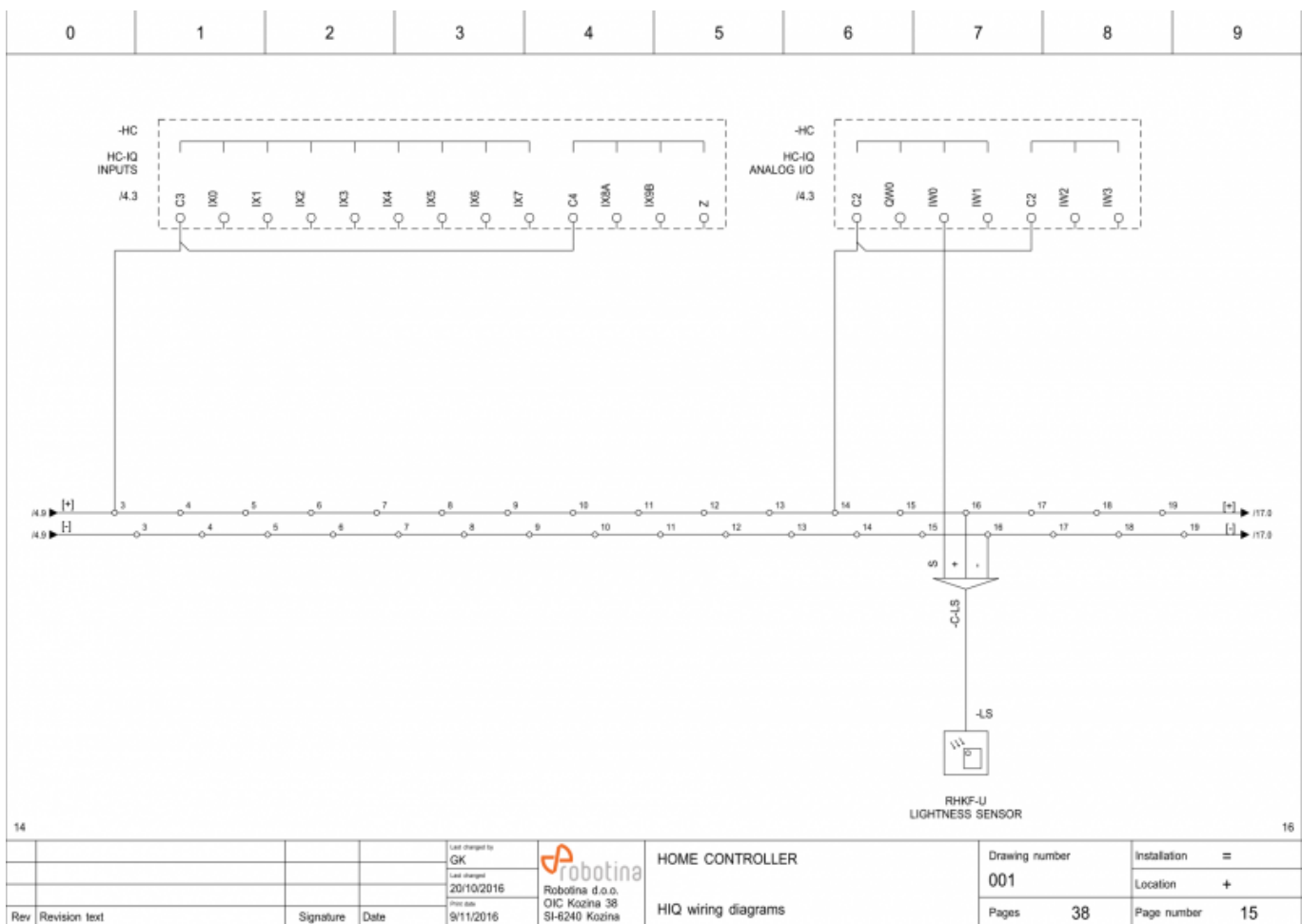

Page 16 - Home controller outputs

QX0-QX4 outputs - can be used for radiator valves or to control other heating/cooling devices. Internal relay is used for valves, other loads are recommended to use an additional 16A installation relay.

In our plan we use 2 radiator valves (and 3 [Fan-coil controllers](#)).

QX5 output - is used for Air Conditioner.

QX6 output - is used for Boiler.

QX7 output - is used for Chiller.

All three outputs are connected to external installation relays (-K.A, -K.B and -K.C) .

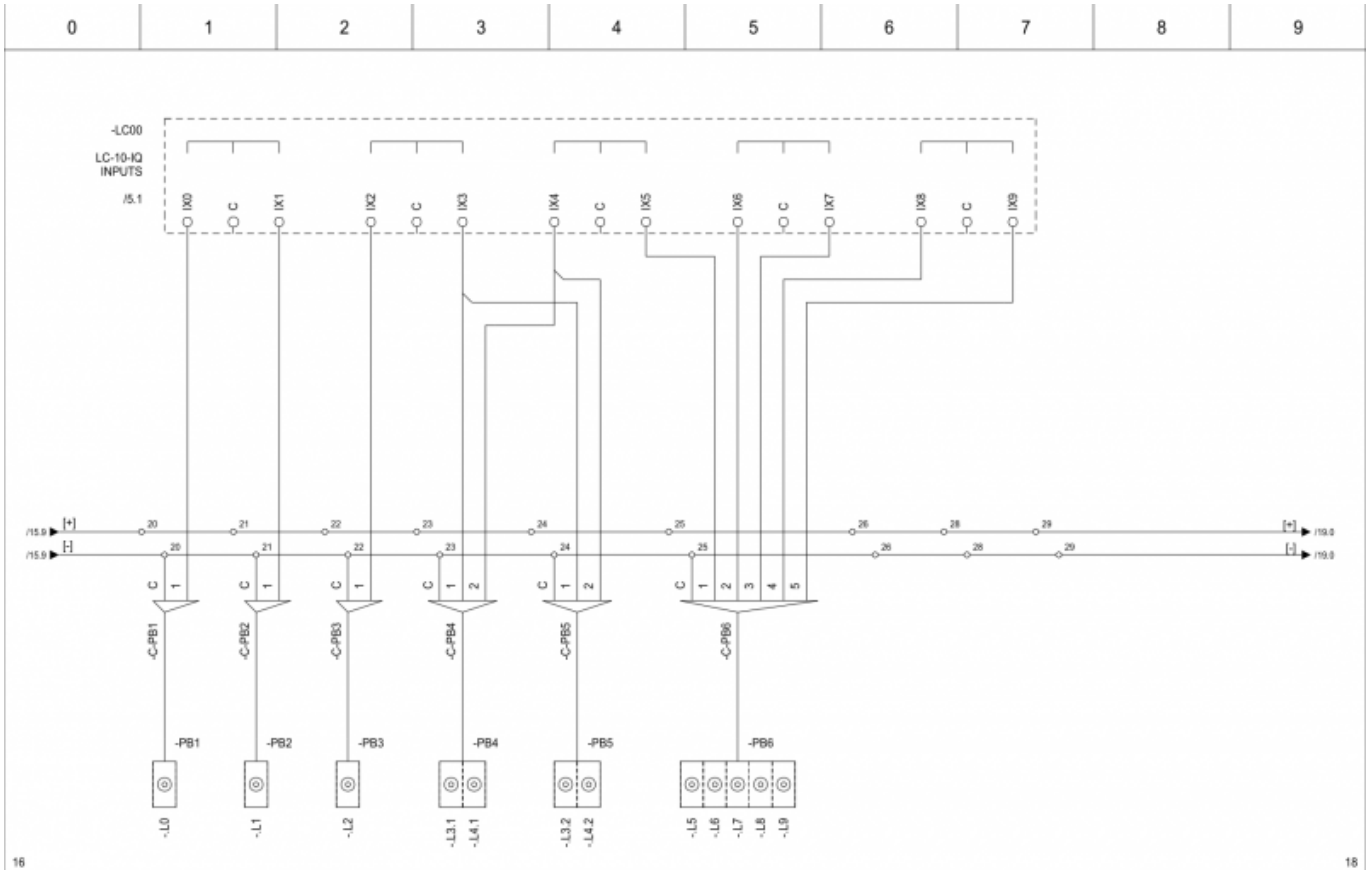

			Last changed by: GK Last changed: 20/10/2016 Print date: 9/11/2016		Robotina d.o.o. OIC Kozina 38 SI-6240 Kozina	LIGHT CONTROLLER HIQ wiring diagrams		Drawing number: 001 Pages: 38		Installation: = Location: + Page number: 17		
Rev	Revision text	Signature	Date									

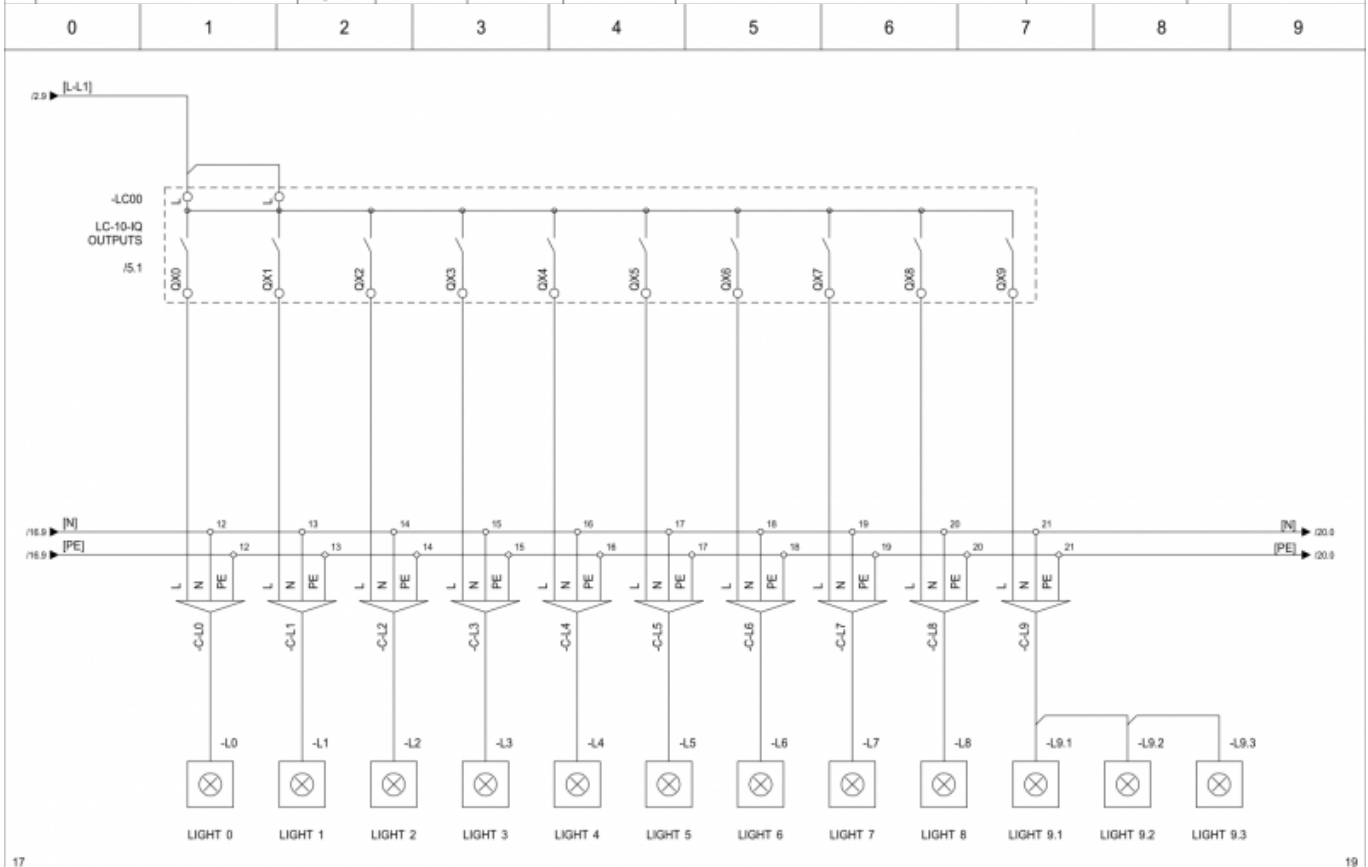

			Last changed by: SS Last changed: 8/11/2016 Print date: 9/11/2016		Robotina d.o.o. OIC Kozina 38 SI-6240 Kozina	LIGHT CONTROLLER HIQ wiring diagrams		Drawing number: 001 Pages: 38		Installation: = Location: + Page number: 18		
Rev	Revision text	Signature	Date									

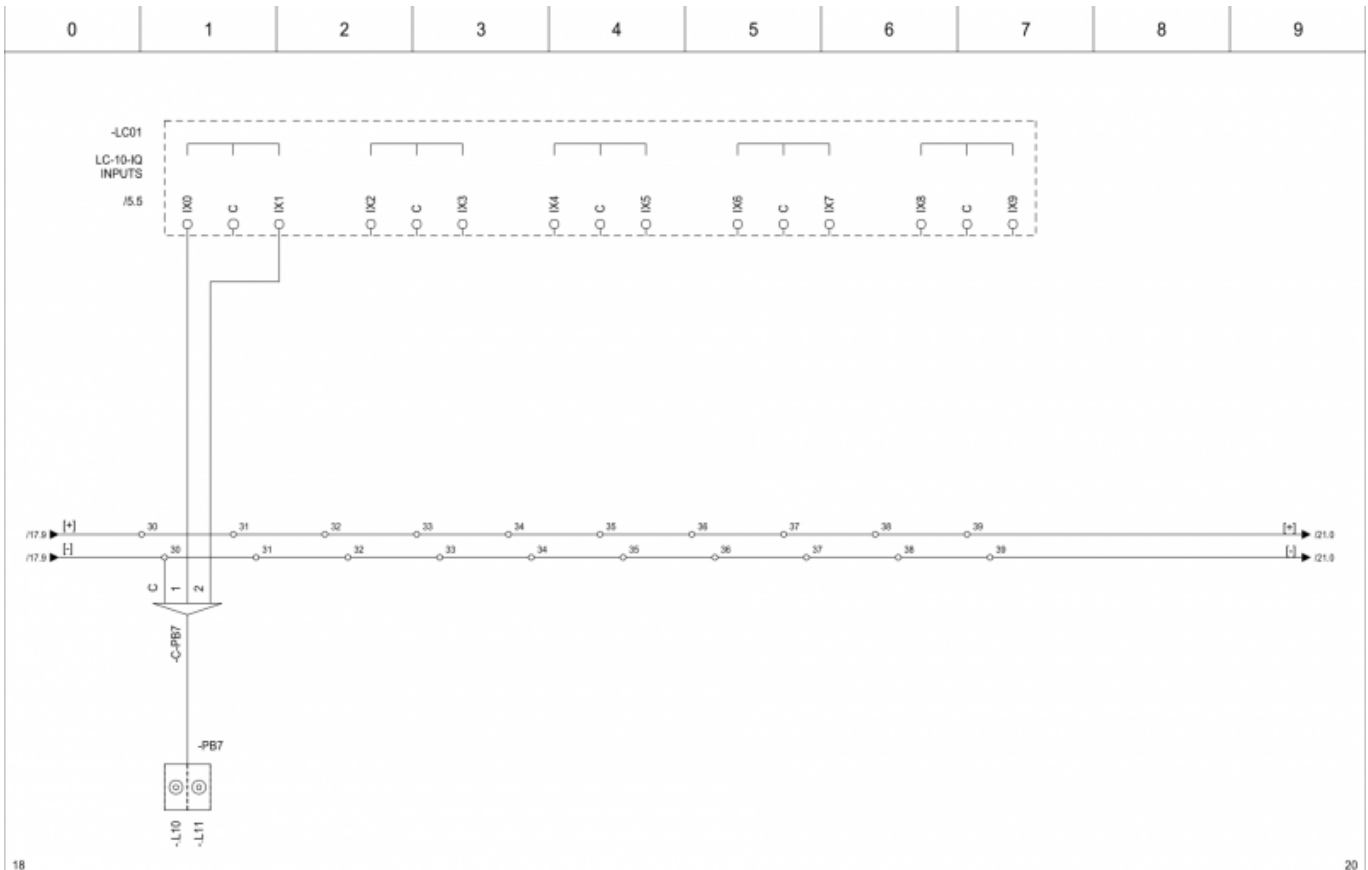

			Last changed to GK		 Robotina d.o.o. OIC Kozina 38 SI-6240 Kozina	LIGHT CONTROLLER		Drawing number 001		Installation =	
			Last changed 20/10/2016			HIQ wiring diagrams		Pages 38		Location +	
Rev	Revision text	Signature	Date	9/11/2016				Page number 19			
0	1	2	3	4	5	6	7	8	9		

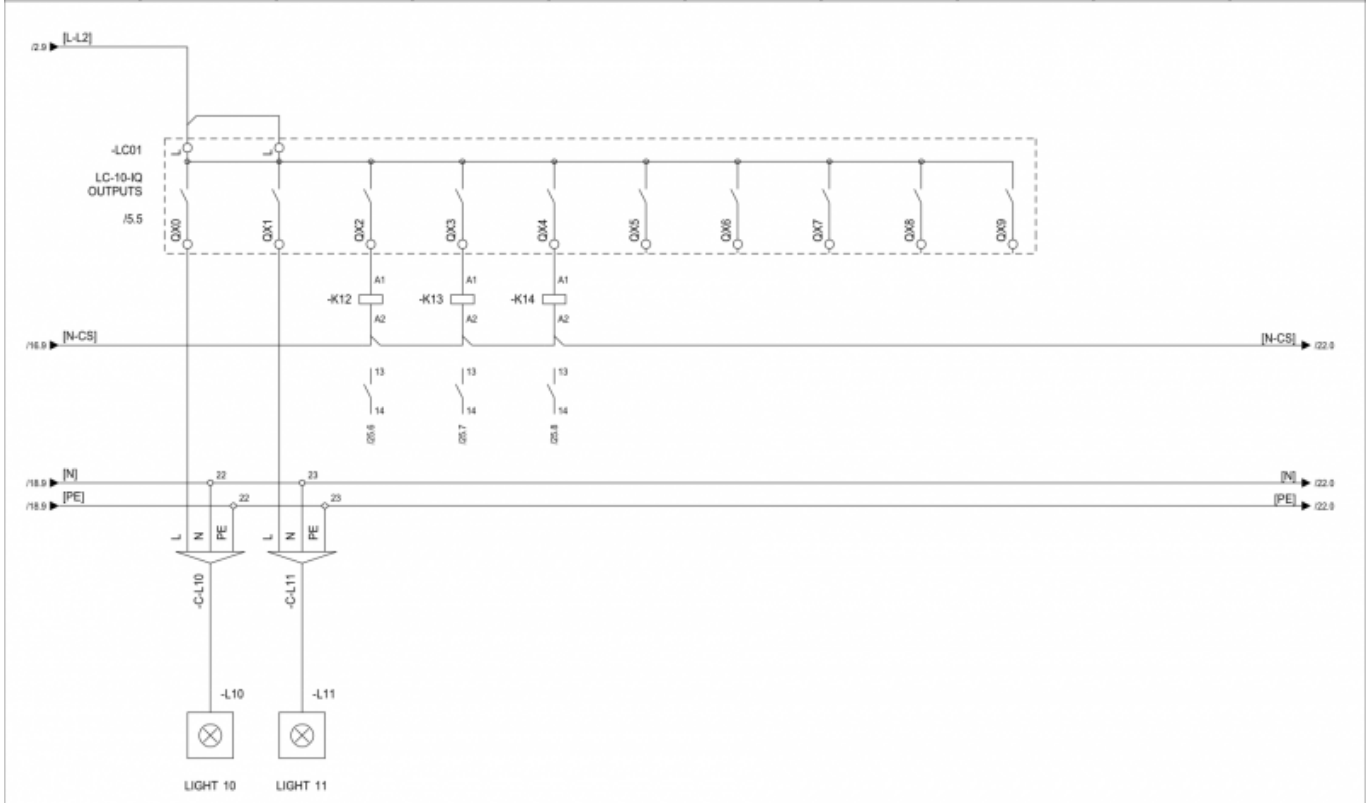

			Last changed to SS		 Robotina d.o.o. OIC Kozina 38 SI-6240 Kozina	LIGHT CONTROLLER		Drawing number 001		Installation =	
			Last changed 9/11/2016			HIQ wiring diagrams		Pages 38		Location +	
Rev	Revision text	Signature	Date	9/11/2016				Page number 20			
0	1	2	3	4	5	6	7	8	9		

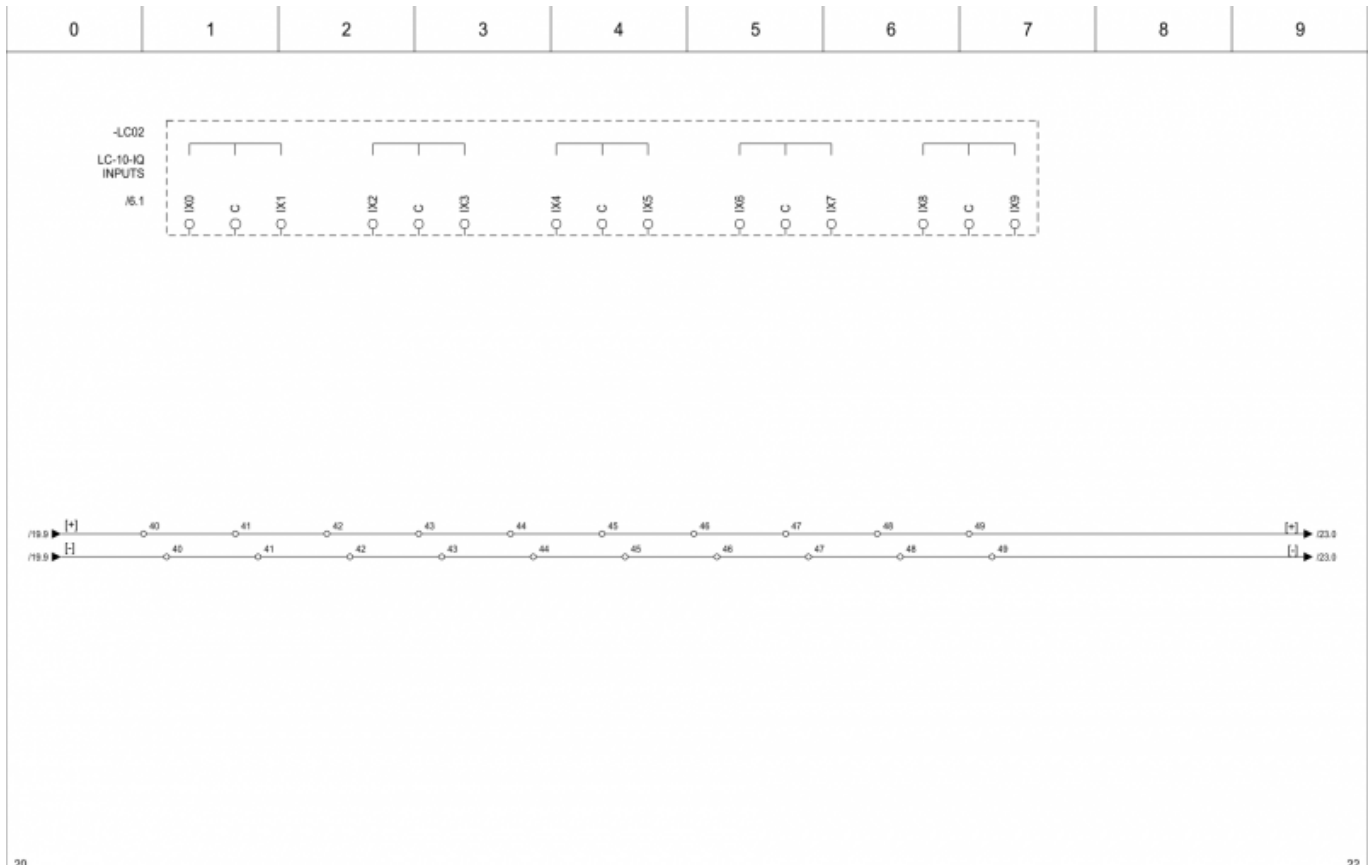

			Last changed by: GK Last changed: 20/10/2016 Print date: 9/11/2016		Robotina d.o.o. OIC Kozina 38 SI-6240 Kozina	LIGHT CONTROLLER HIQ wiring diagrams		Drawing number: 001 Pages: 38		Installation: = Location: + Page number: 21	
Rev	Revision text	Signature	Date								

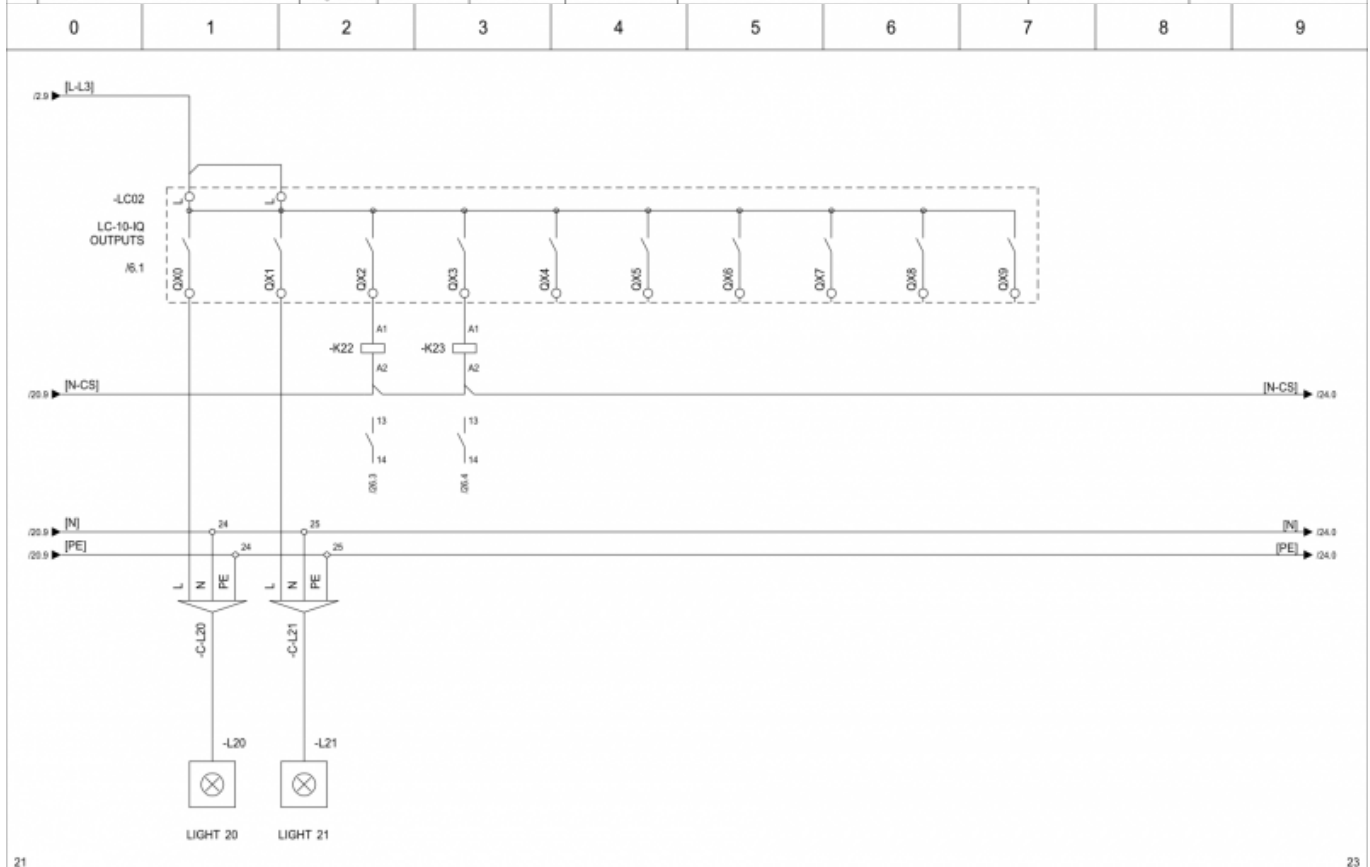

			Last changed by: GK Last changed: 2/11/2016 Print date: 9/11/2016		Robotina d.o.o. OIC Kozina 38 SI-6240 Kozina	LIGHT CONTROLLER HIQ wiring diagrams		Drawing number: 001 Pages: 38		Installation: = Location: + Page number: 22	
Rev	Revision text	Signature	Date								

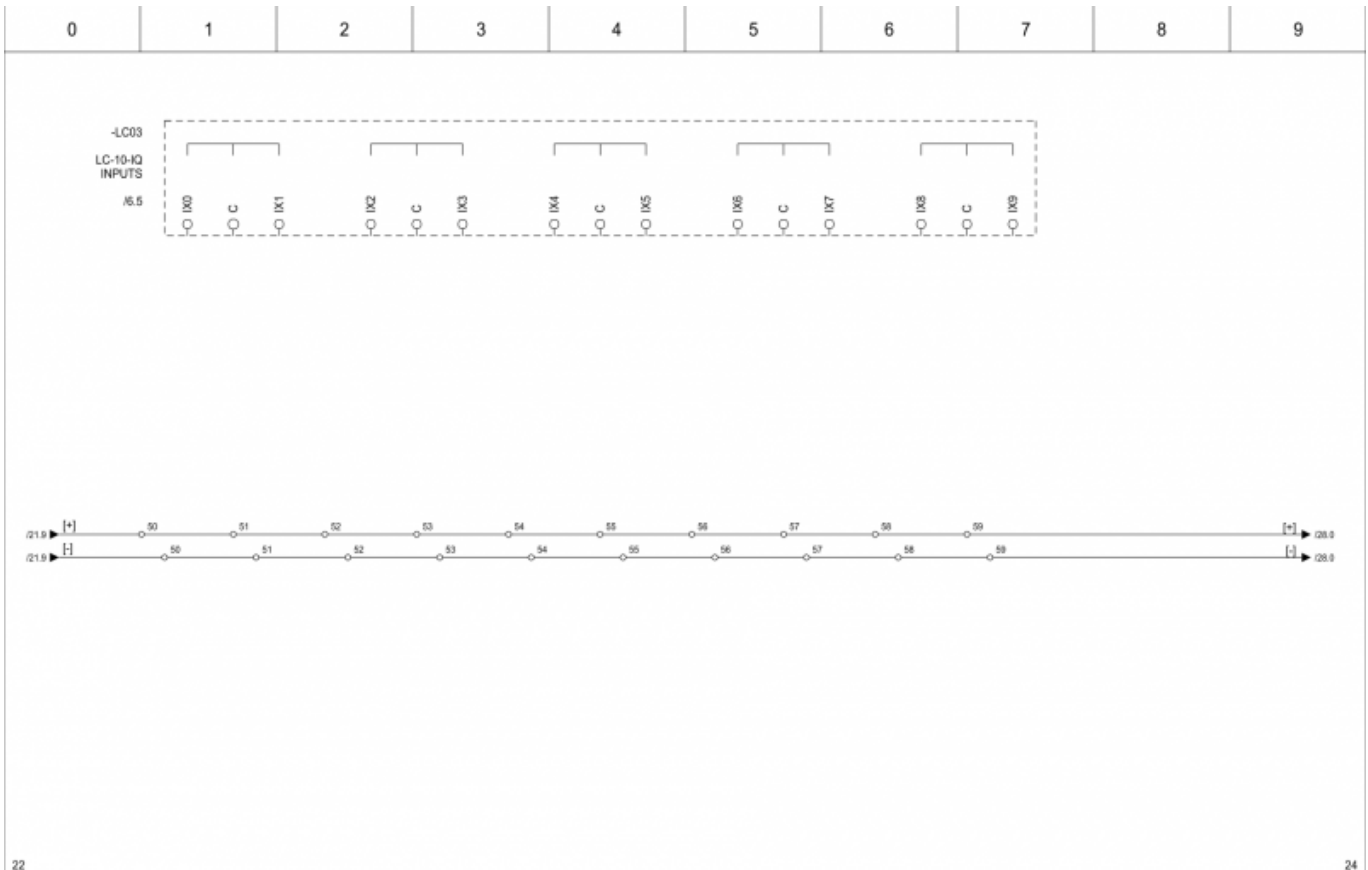

			Last changed by GK		 Robotina d.o.o. OIC Kozina 38 SI-6240 Kozina	LIGHT CONTROLLER		Drawing number 001		Installation =	
			Last changed 22/10/2016			HIQ wiring diagrams		Pages 38		Location +	
Rev	Revision text	Signature	Date	9/11/2016				Page number 23			
0	1	2	3	4	5	6	7	8	9		

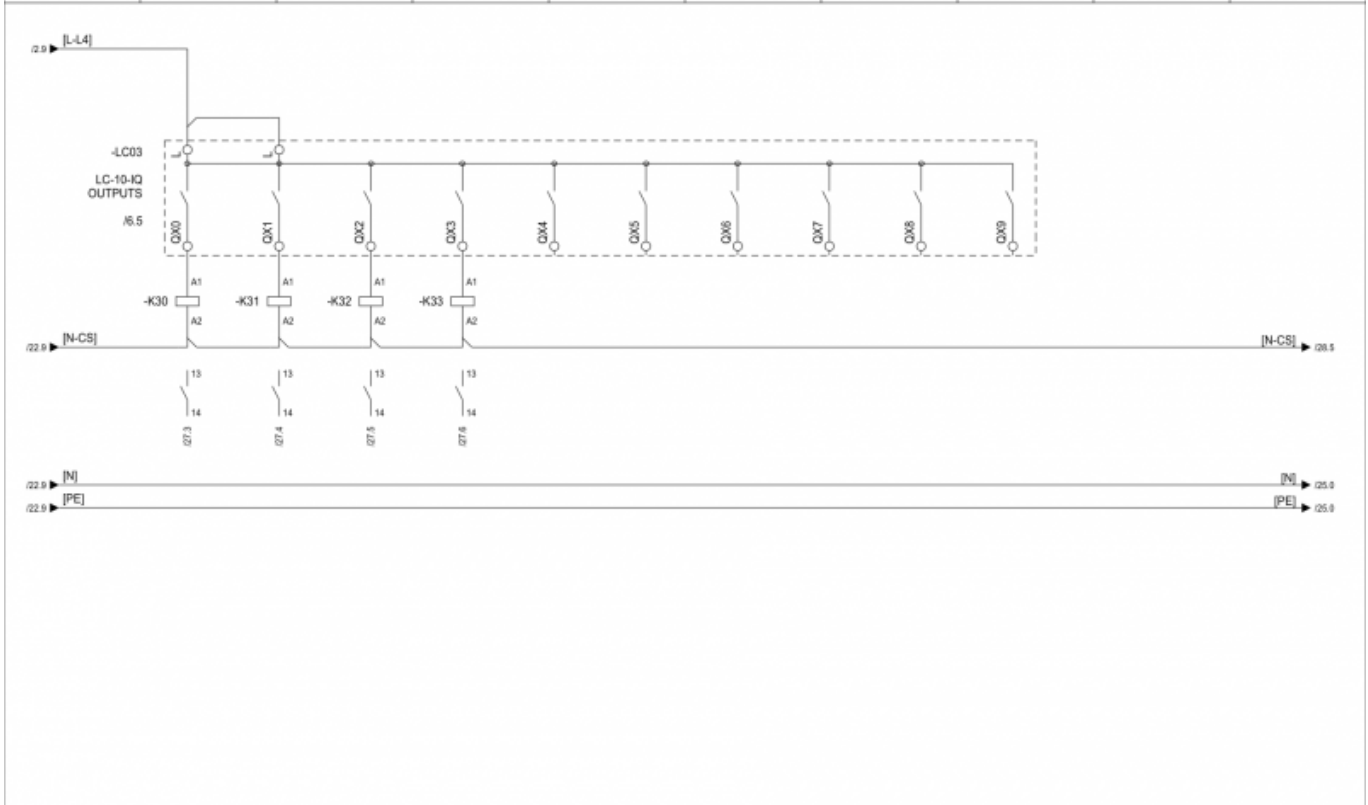

			Last changed by GK		 Robotina d.o.o. OIC Kozina 38 SI-6240 Kozina	LIGHT CONTROLLER		Drawing number 001		Installation =	
			Last changed 2/11/2016			HIQ wiring diagrams		Pages 38		Location +	
Rev	Revision text	Signature	Date	9/11/2016				Page number 24			
0	1	2	3	4	5	6	7	8	9		

Page 25-27 - Power sockets

A sample plan assumes use of managed and unmanaged sockets. Managed sockets are connected to [Light controllers](#). External installation relays should be used on Light controller outputs.

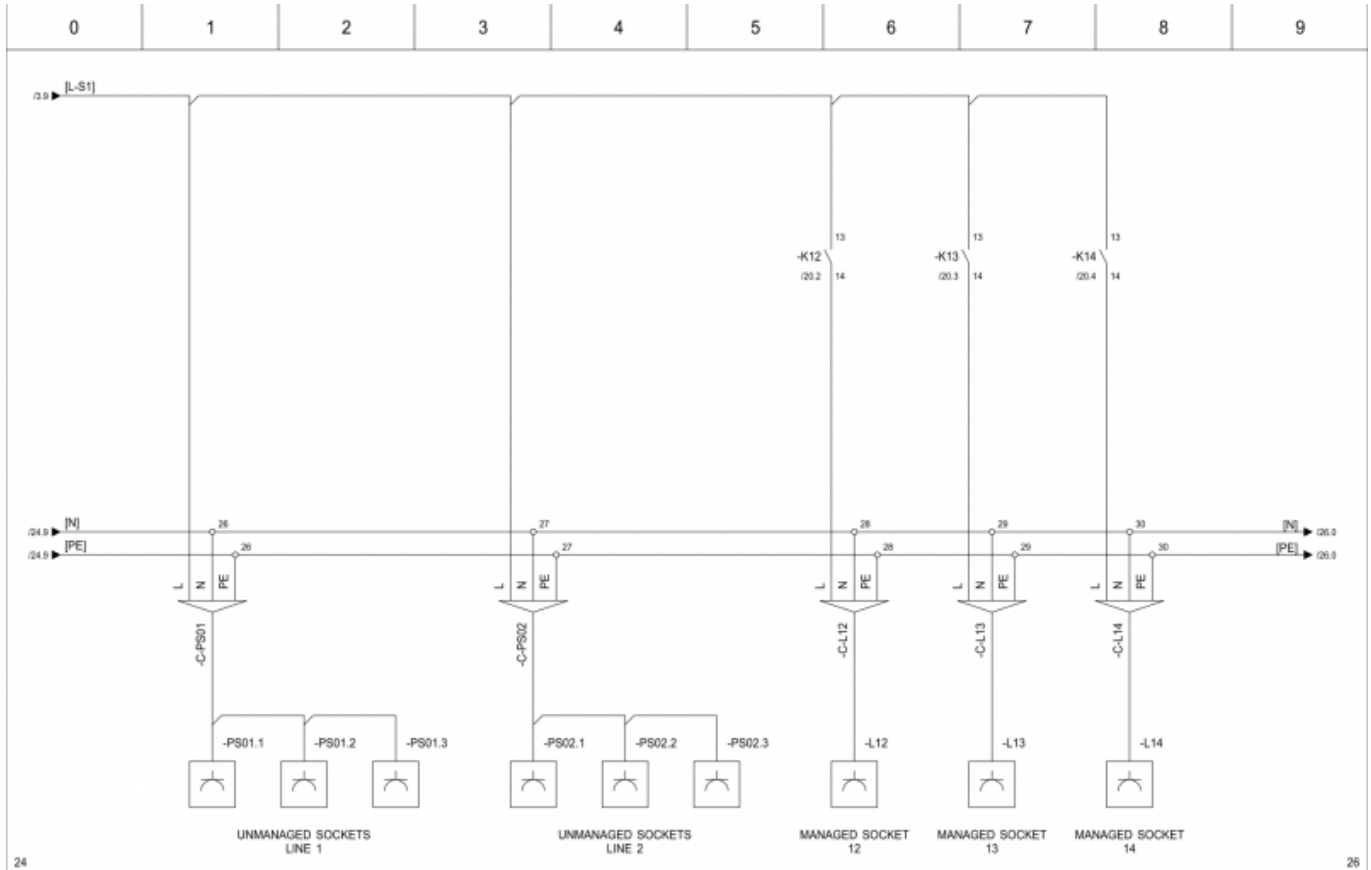

		Last changed by: GK		 Robotina d.o.o. OIC Kozina 38 SI-6240 Kozina	POWER SOCKETS HIQ wiring diagrams	Drawing number: 001		Installation: =	
		Last changed: 2/11/2016				Pages: 38		Location: +	
Rev		Revision text				Signature		Date	

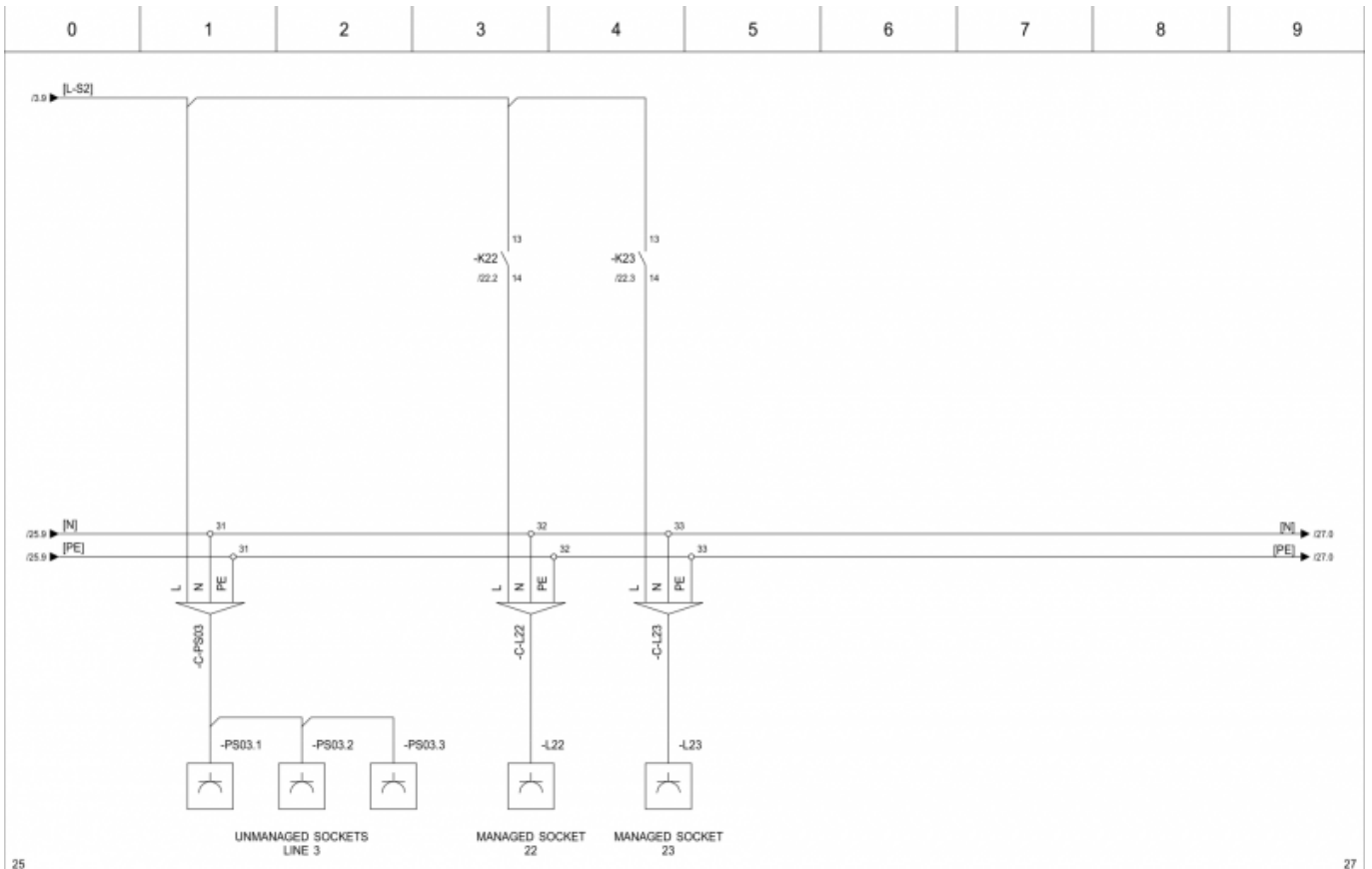

			Last changed by GK Last changed 2/11/2016 Drawn by S/11/2016		Robotina d.o.o. OIC Kozina 38 SI-6240 Kozina	POWER SOCKETS HIQ wiring diagrams		Drawing number 001		Installation = Location +		
Rev			Revision text			Signature		Date		Pages 38		Page number 26
0	1	2	3	4	5	6	7	8	9			

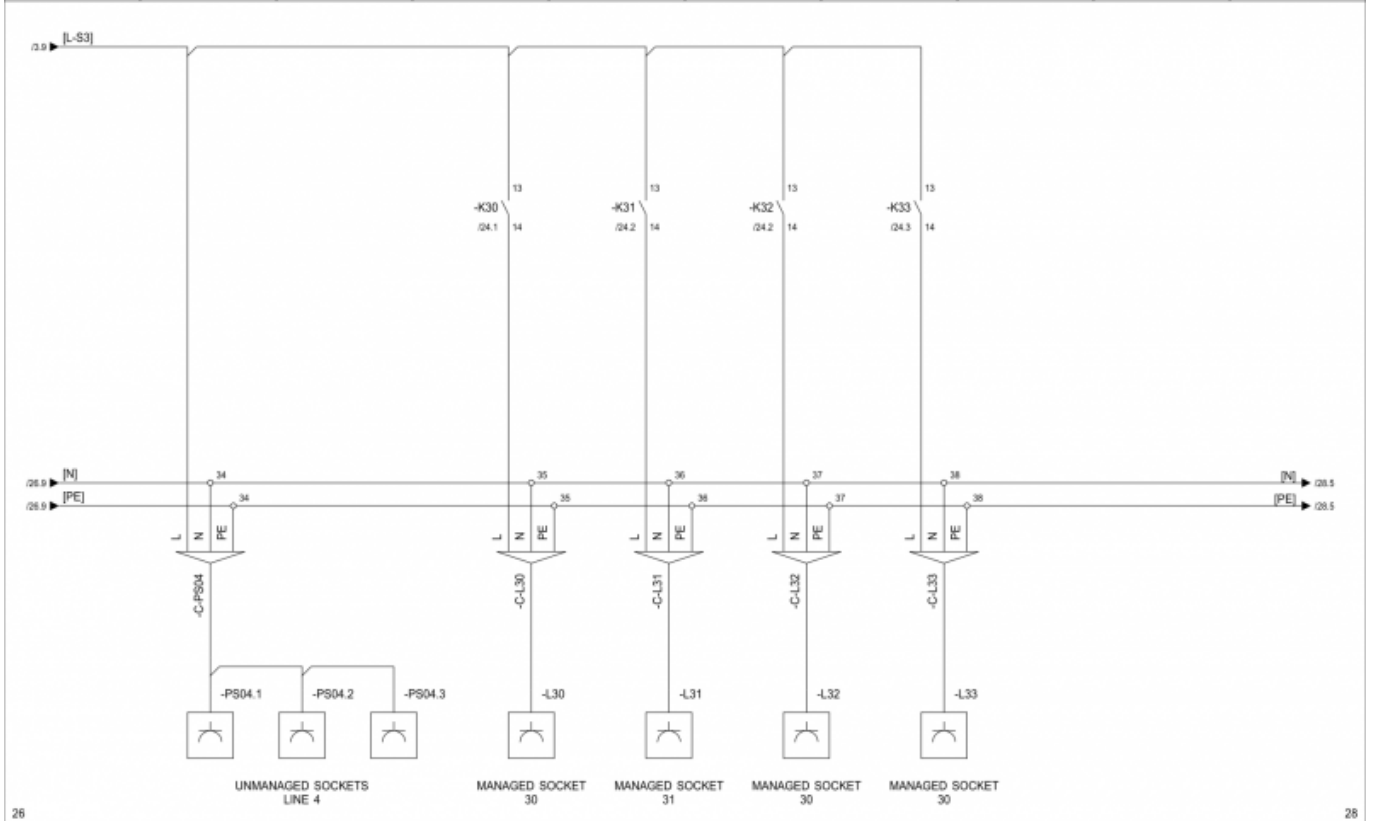

			Last changed by GK Last changed 2/11/2016 Drawn by S/11/2016		Robotina d.o.o. OIC Kozina 38 SI-6240 Kozina	POWER SOCKETS HIQ wiring diagrams		Drawing number 001		Installation = Location +		
Rev			Revision text			Signature		Date		Pages 38		Page number 27
0	1	2	3	4	5	6	7	8	9			

Page 28-29 - Light dimmers

On sample plan we use 2 Light dimmers drivers. On each driver we can connect up to 4 LUD-12 universal light dimmers.

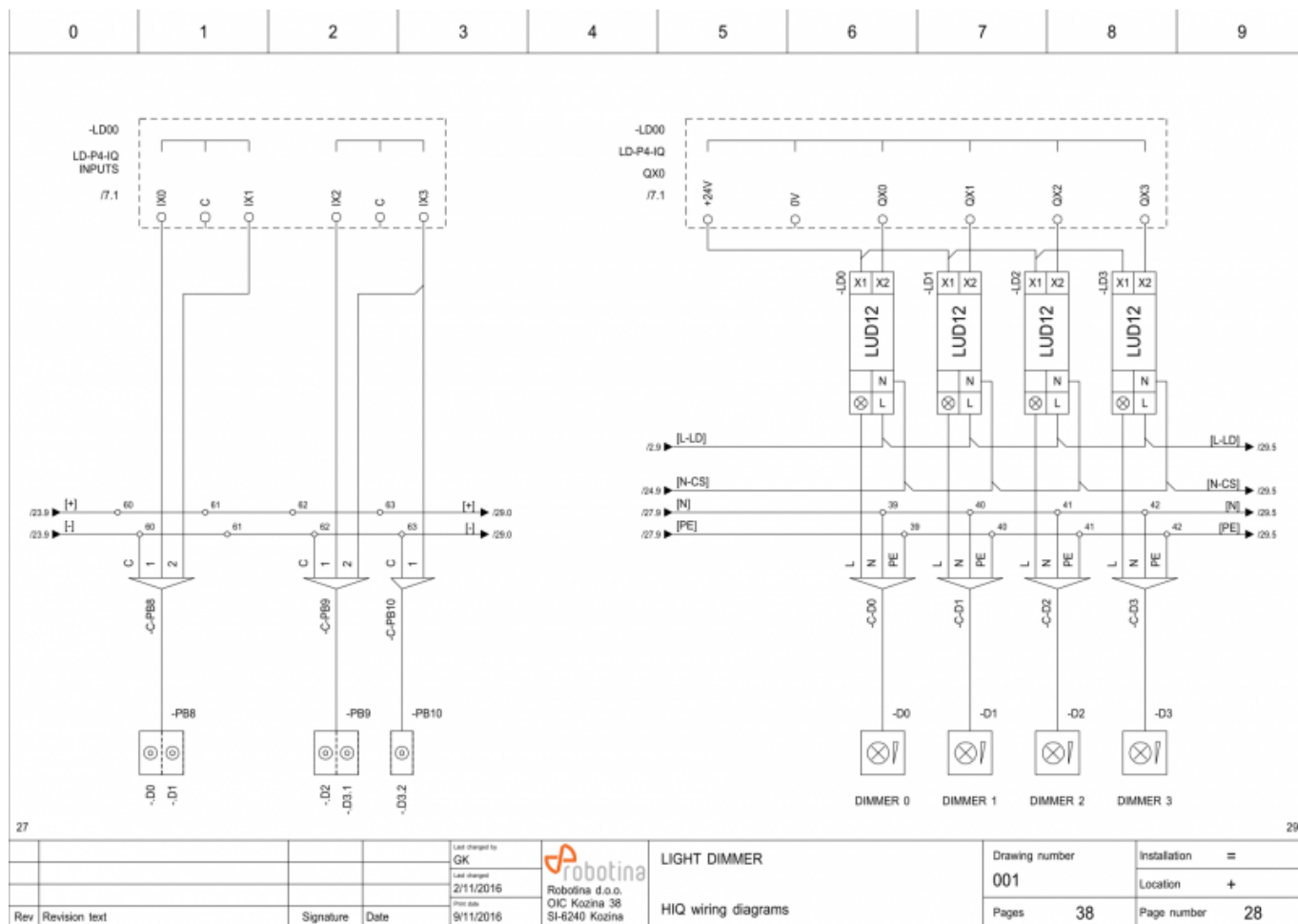

		Last changed by GK Last changed 2/11/2016 Project 9/11/2016		 Robotina d.o.o. OIC Kozina 38 SI-6240 Kozina	LIGHT DIMMER HIQ wiring diagrams	Drawing number 001		Installation =	
Rev Revision text		Signature Date				Pages 38		Location + Page number 28	

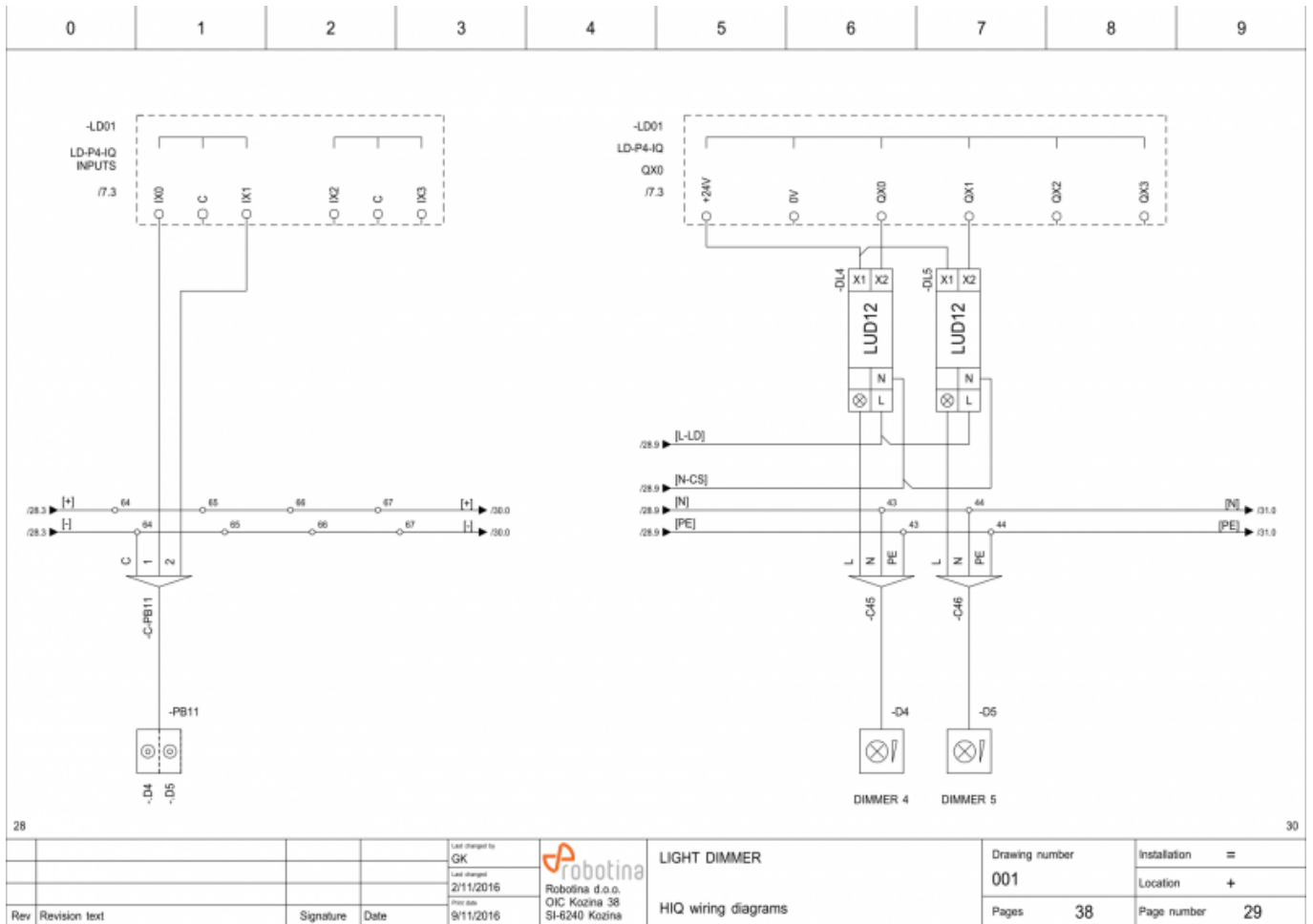

Page 30-33 - Blinds controllers

On our sample plan we have 2 [Blinds controllers \(BC\)](#) with 9 blinds and 9 double-push buttons.

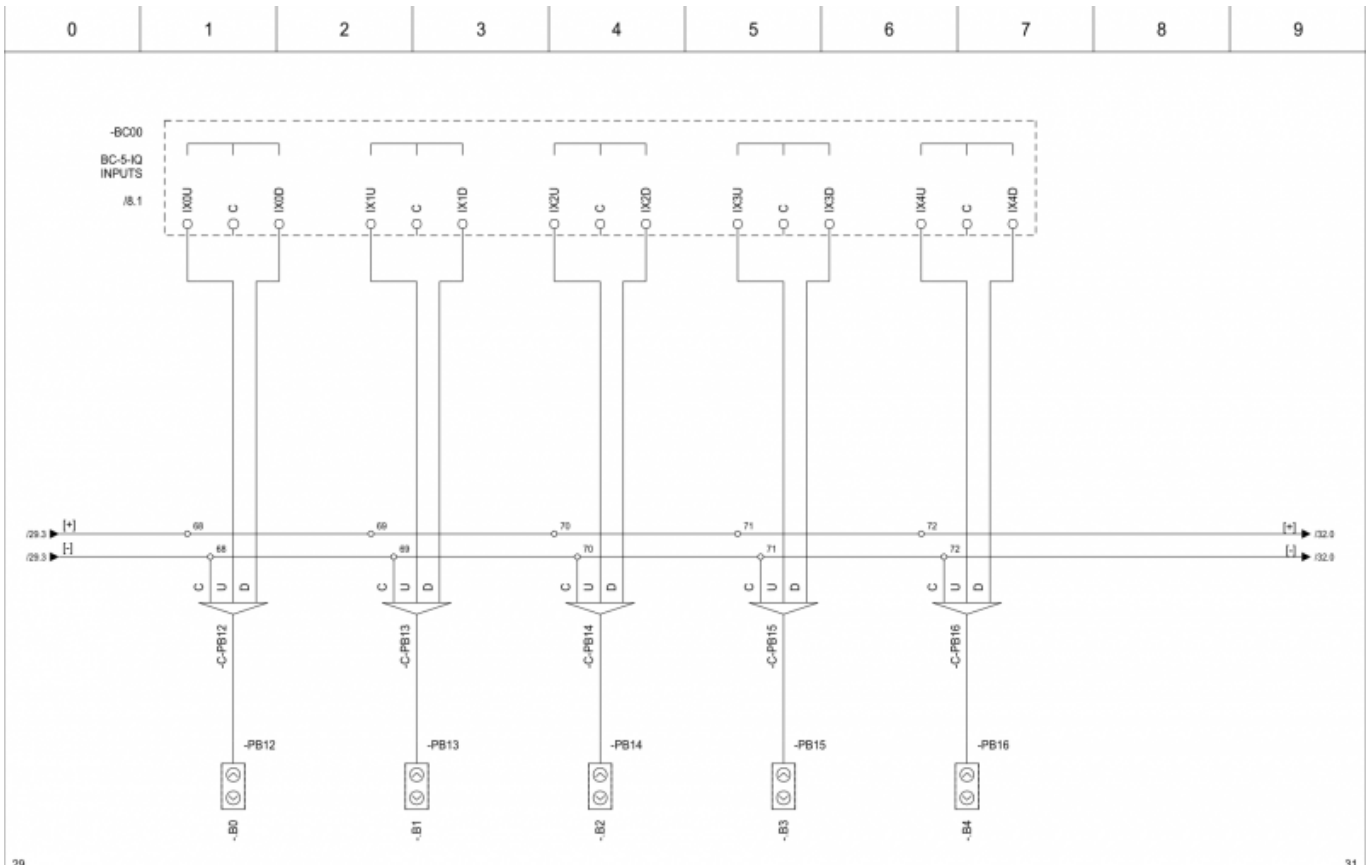

			Last changed by: GK Last changed: 20/10/2016 Print date: 9/11/2016		Robotina d.o.o. OIC Kozina 38 SI-6240 Kozina	BLINDS CONTROLLER HIQ wiring diagrams		Drawing number: 001 Pages: 38		Installation: = Location: + Page number: 30	
Rev	Revision text	Signature	Date								

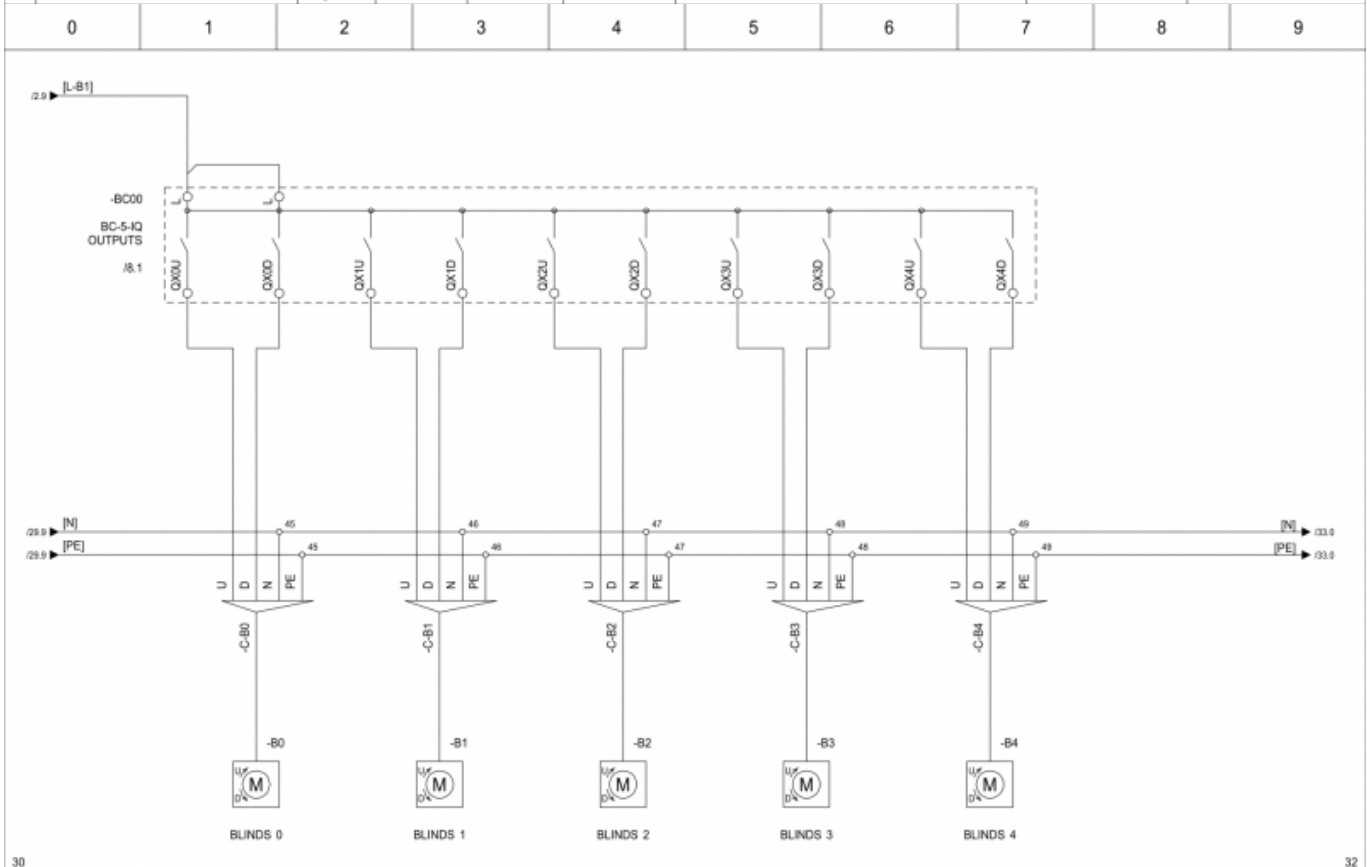

			Last changed by: GK Last changed: 2/11/2016 Print date: 9/11/2016		Robotina d.o.o. OIC Kozina 38 SI-6240 Kozina	BLINDS CONTROLLER HIQ wiring diagrams		Drawing number: 001 Pages: 38		Installation: = Location: + Page number: 31	
Rev	Revision text	Signature	Date								

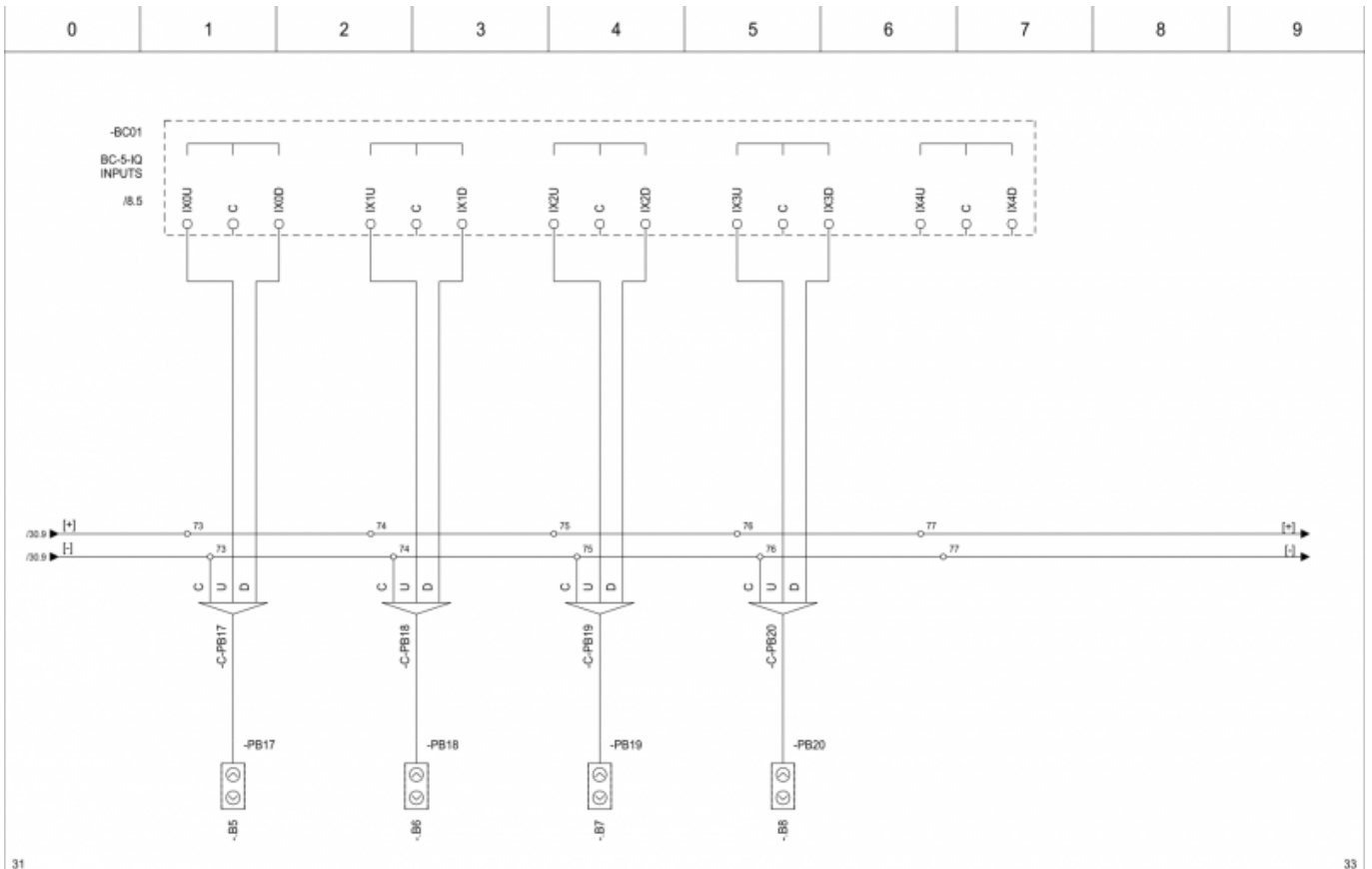

31 33

				Last changed by GK Last changed 20/10/2016 Drawn by 9/11/2016	Robotina d.o.o. OIC Kozina 38 SI-6240 Kozina	BLINDS CONTROLLER HIQ wiring diagrams		Drawing number 001	Installation = Location +
Rev	Revision text	Signature	Date	9/11/2016		Pages	38	Page number	32
0	1	2	3	4		5	6	7	8

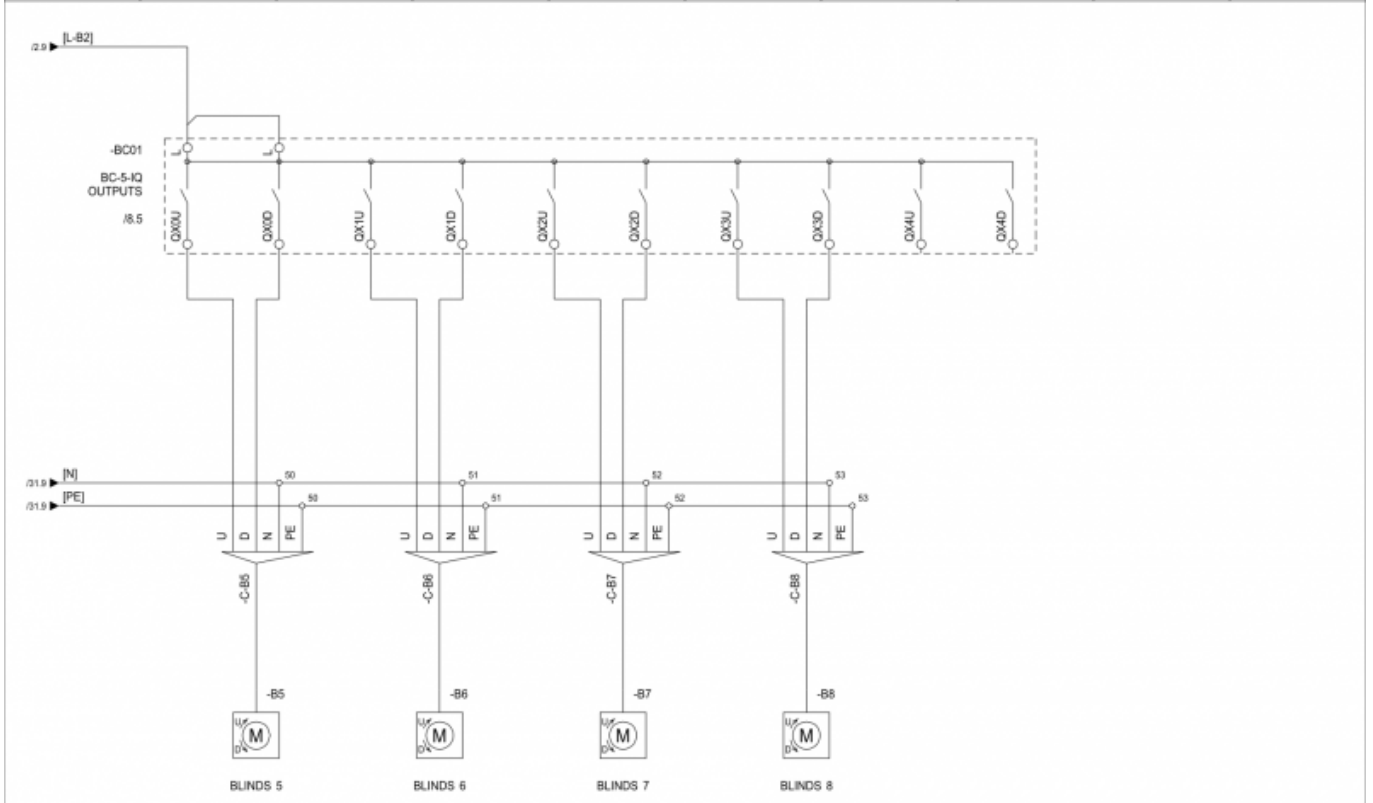

32 34

				Last changed by GK Last changed 2/11/2016 Drawn by 9/11/2016	Robotina d.o.o. OIC Kozina 38 SI-6240 Kozina	BLINDS CONTROLLER HIQ wiring diagrams		Drawing number 001	Installation = Location +
Rev	Revision text	Signature	Date	9/11/2016		Pages	38	Page number	33
0	1	2	3	4		5	6	7	8

Page 34-35 - LED stripe dimmer

On sample plan we use 2 LED stripe dimmers. RGBW (red-green-blue-white) LED stripe is connected on the first dimmer and the second dimmer controls 2 white LED stripes (2 outputs are empty). 2 push buttons are connected on the second dimmer.

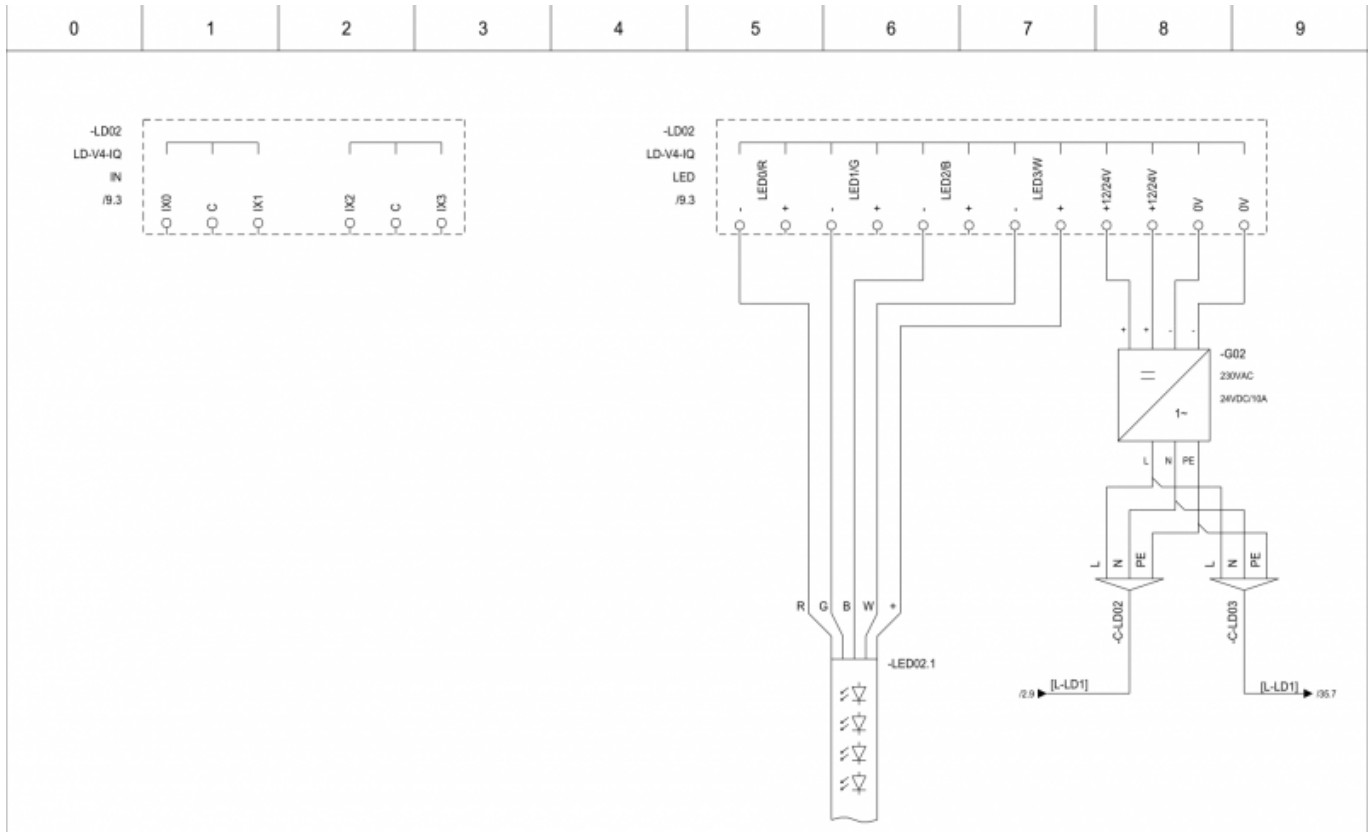

			Last changed by SS Last changed 9/11/2016 Draw date 9/11/2016	Robotina d.o.o. OIC Kozina 38 SI-6240 Kozina	LIGHT DIMMER HIQ wiring diagrams	Drawing number 001	Installation =
Rev Revision text	Signature	Date	Pages 38			Location +	Page number 34

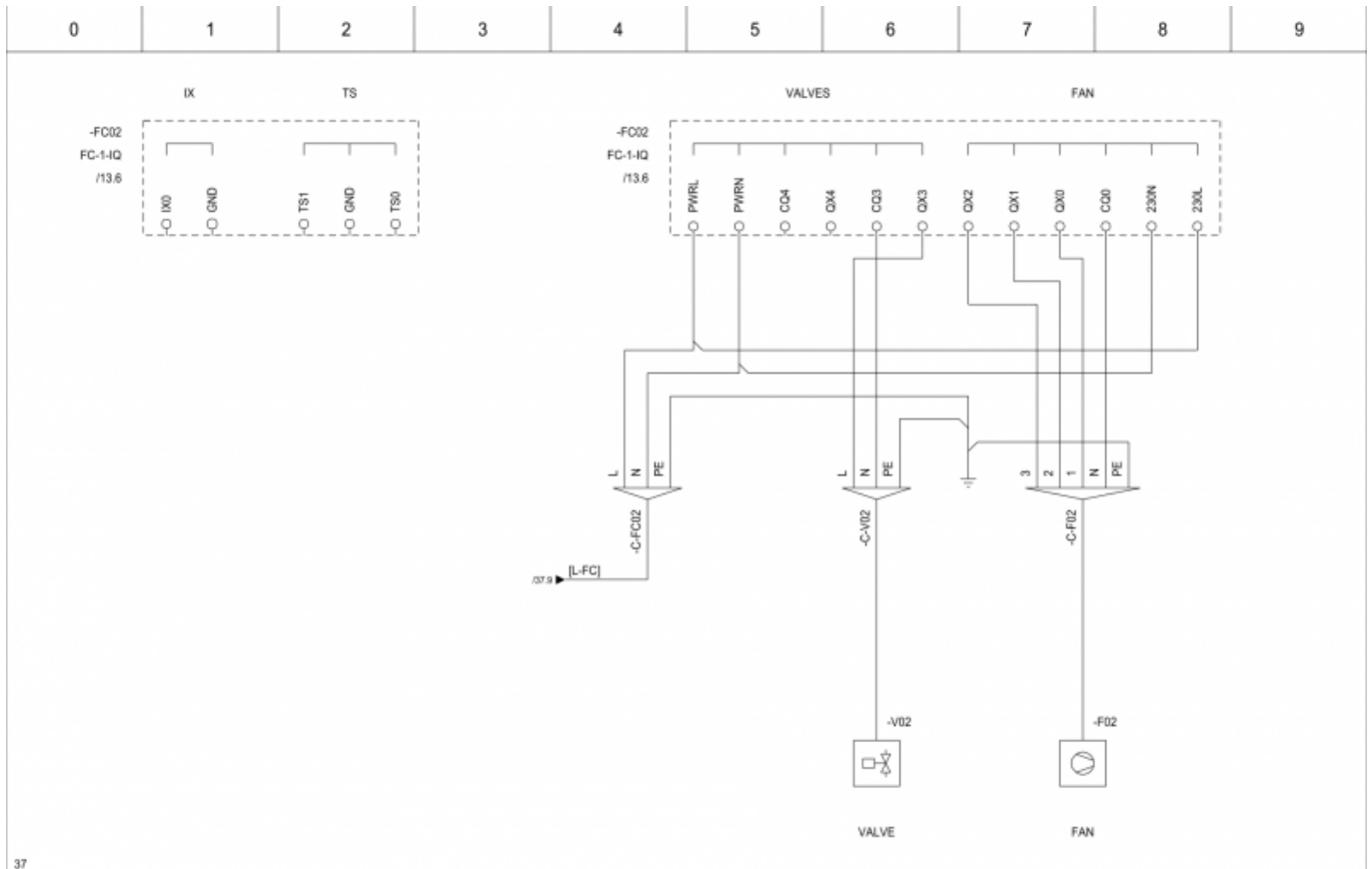

37

				Last changed by GK Last changed 2/11/2016 Drawn by SI/11/2016	 Robotina d.o.o. OIC Kozina 38 SI-6240 Kozina	FAN-COIL HIQ wiring diagrams	Drawing number 001 Pages 38	Installation = Location + Page number 38
Rev	Revision text	Signature	Date					

From:
<http://wiki.hiq-universe.com/> -

Permanent link:
http://wiki.hiq-universe.com/doku.php?id=en:hiq_home:methods:design&rev=1538747328

Last update: **2018/10/05 13:48**

