

# Wireless Modbus-to-Modbus bridge

## Wireless Modbus-to-Modbus bridge





Model number:	<b>WM-1</b>
Frequency:	ISM 868MHz (EU)
Dimensions:	93x45x27 mm

## Applications

- Replacement for RS485 wiring solution with wireless. Optimal for long range Modbus RTU serial communications with half duplex configuration.

## Installation and mounting

-  Carefully open WM-1 module and configure serial communication with jumpers. (Default configuration is 9600bps, 8N1 with normal timeout)
-  Place WM-1 module at least 10cm from other objects. Installation is not recommended inside metal cabinets.
- Connect RS485 terminals to WM-1 RS485 terminals
  - A - A
  - B - B
  - C - GND
- Connect to 230V power supply
- Configure radio pairing



## Features

- replacement for RS485 wiring
- Modbus RTU serial protocol
- wired/wireless combinations
- very long range, no hopping
- protected private connection
- multiple slaves per device
- multiple addressable groups

## Technical specification

Power supply:	230V, 50/60Hz, 1W
Ingress protection:	IP20
Operating temperature:	-20..50°C
Storage temperature:	-40..85°C
Relative humidity:	0..85% n/c

## Terminals and wiring

To power sensor	<b>A</b>	RS485 bus
	<b>B</b>	
	<b>C</b>	
To power supply	<b>L</b>	230V AC
	<b>N</b>	

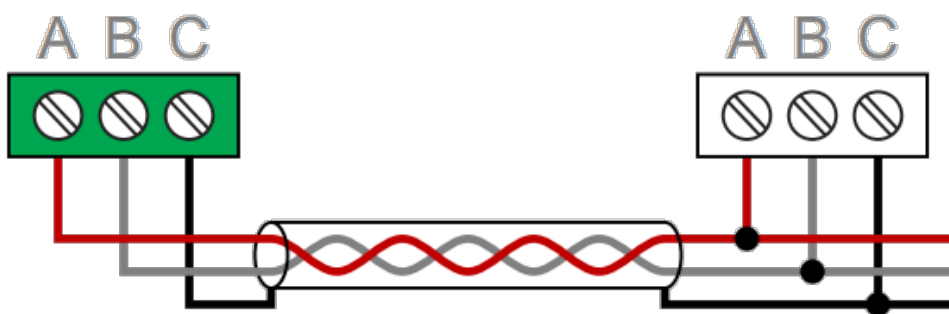

# Serial configuration and timeout

- Available baudrates 2400, 9600, 19200, 38400 bps
- Data bits and parity 8N1, 7E1, 8E1, 8N2
-  Max 64 bytes per transmission
- Integrated 240 Ohm termination resistor



	normal	extended
2400	25ms	200ms
9600	10ms	100ms
19200	5ms	100ms
38400	5ms	100ms

## Radio configuration

### Create new secure group

- \* turn on all devices as the same time
- \* within 10 seconds, while RF LED is blinking, press and hold button on one of the devices
- \* after a second, the new address is randomly generated and sent to all devices. RF LED will blink 3 times to confirm the new address.

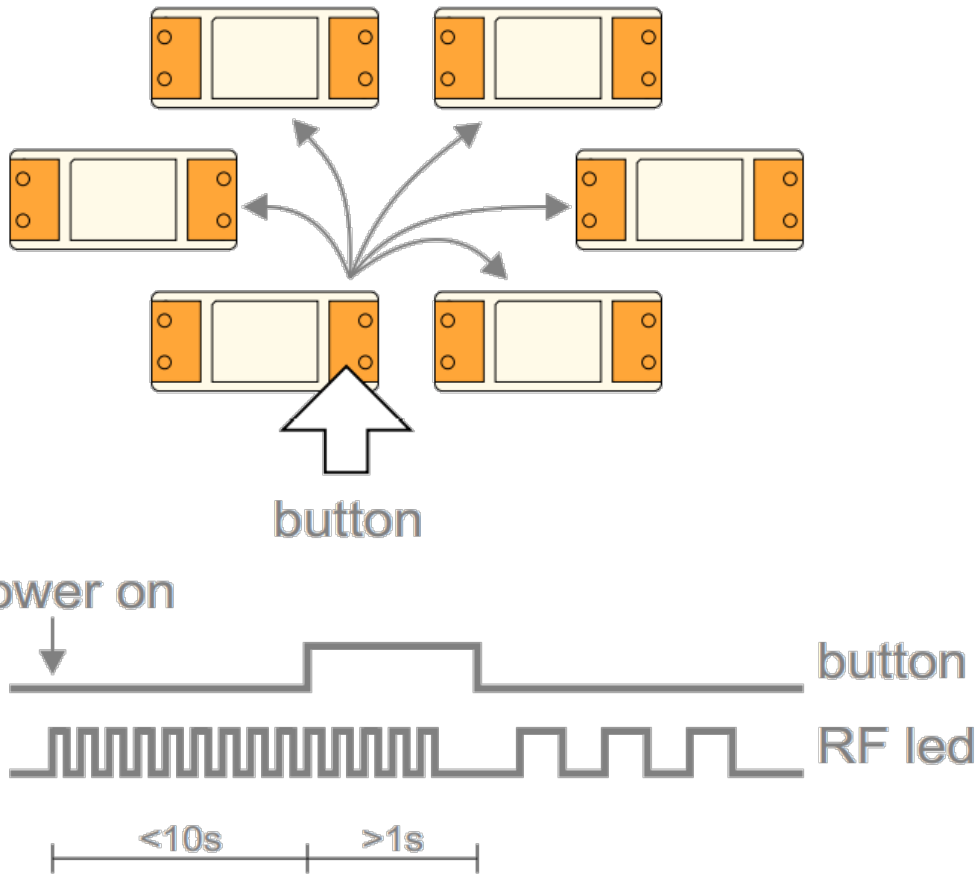

### Add new device to the group

- \* turn on the device
- \* within 10 seconds, press and hold button on one of the existing devices
- \* after a second, the existing group address is sent to the new device. RF LED will blink 3 times to confirm the address is sent.

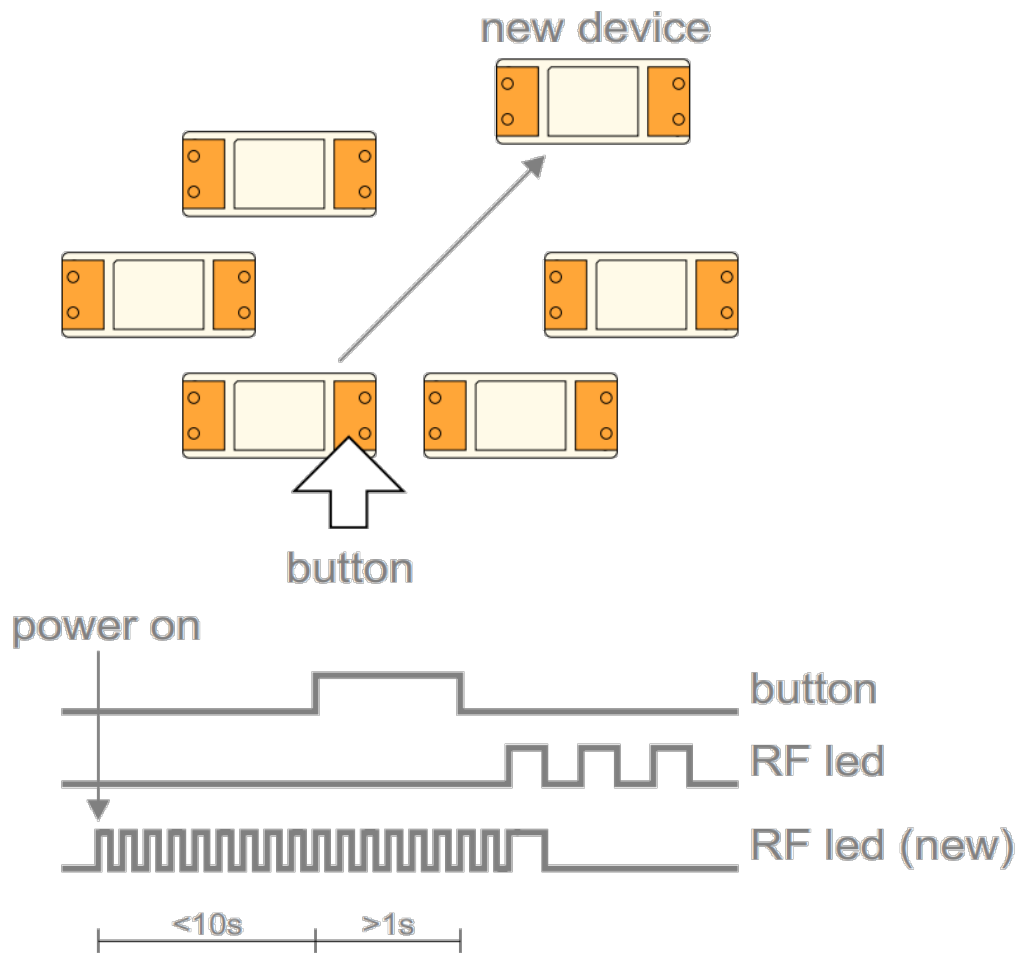

### Topology examples

- \* Modbus master, connected to 12 slaves using a pair of WM-1 devices
- \* Modbus master, connected to 10 slaves, organized in two groups
- \* Modbus master, connected to 5 slaves, each one having local WM-1 device



### Multiple groups

- \* When the system has two or more separate Modbus lines, they should be configured as separate groups.
- \* Each group has a single master and one or more slaves.
- \* Groups can't talk to each other, but they share the same bandwidth.
- \* Two masters may start transmitting at the same time causing collisions.
- \* To reduce number of missed messages, keep the traffic low.



### Connection check

- Press button shortly
- RF LED will blink shortly on each connected device

- Serial interface is unaffected



## Factory reset

- Hold button and turn the device ON
- RF led will blink twice. Group address is now reset to default.
- Other devices will not be affected.

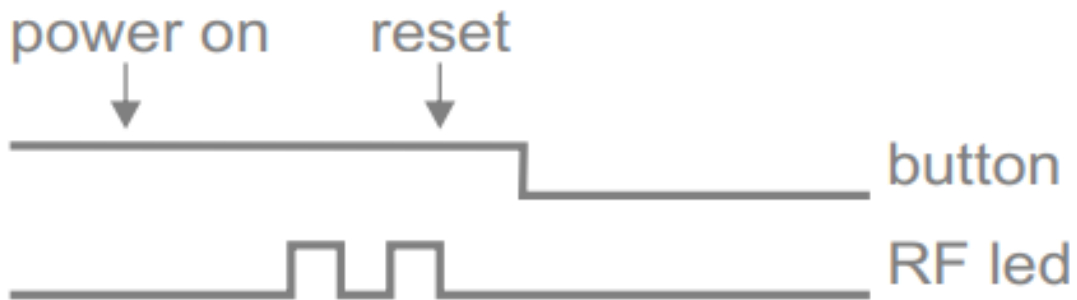

From:  
<http://wiki.hiq-universe.com/> -

Permanent link:  
[http://wiki.hiq-universe.com/doku.php?id=en:hiq\\_hw:wm-1&rev=1634823630](http://wiki.hiq-universe.com/doku.php?id=en:hiq_hw:wm-1&rev=1634823630)

Last update: **2021/10/21 13:40**

