

Motion sensor DALI

Passive infrared DALI detector ceiling recessed



Model number:	IR-C12D-LC
Connects to:	DALI
Mounting:	In ceiling
Dimensions:	90x90x40.54mm

Applications

- Motion detector
- Ready light
- Intrusion detector
- Lighting control
- Hotel GRMS

Features

- Aestetical look
- Easy mount
- Powered by DALI bus
- Simple Group Assignment Via Rotary Switch
- High sensitivity PIR sensor

General description

A passive infrared detector with sleek and compact housing on DALI system.

Installation instruction

- Do not install the detector at position which faces direct or reflected sunlight or near windows with direct car headlight.
- Ensure that there are no obstructions (plants, screens, furniture etc.) in the field of view that may cause incorrect cover/operation of the detector.
- Avoid locating the detector in areas that contain equipment that may change the environment temperature rapidly (i.e. above radiator or under the air-conditioner)
- Install the detector at proper height on a rigid surface. Do not install the detector on vibrating surface.
- PIR detector is more sensitive to the motions “across” the detection zones than “toward” or “away”.

Range



Technical specifications

Current draw	10 mA from DALI bus
Temperature	0°C ~ 50°C
Operating humidity	10%-80% RH Non-Condensing
Connecting Wires	0.5~1.5 mm ² , solid or stranded wire
Weight	58g

Dimensions

All Dimensions in Inches[mm]

Tolerance Inches:x.xxx=±0.02

Millimeters: x.xx=±0.5

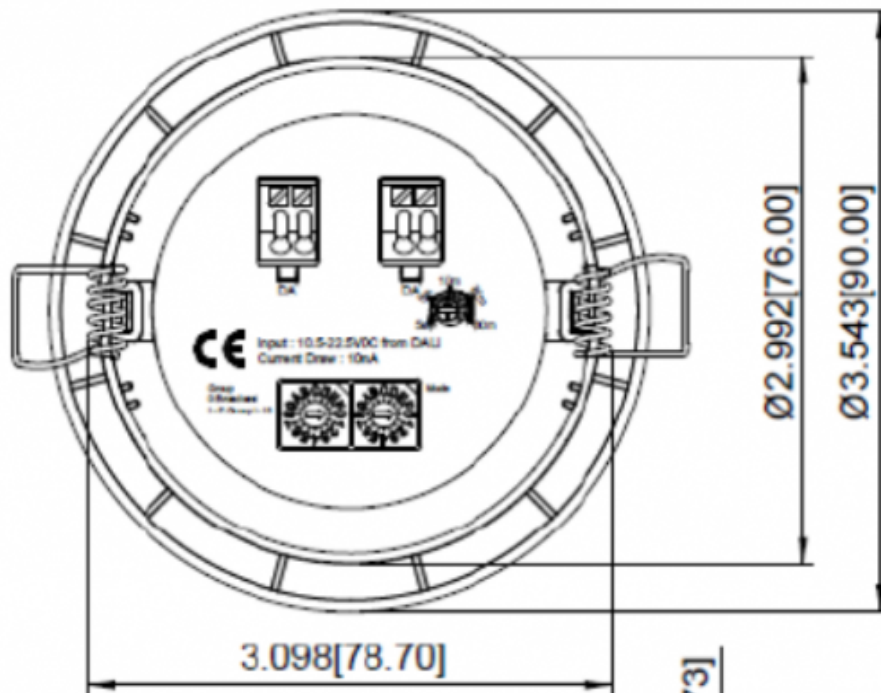

PIR LED

Status LED

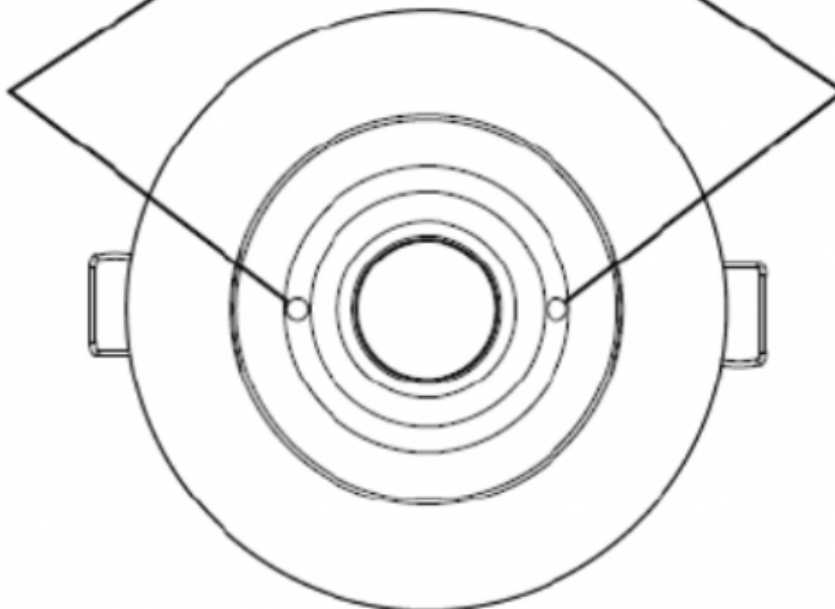

Terminals

DALI	+
DALI	-

Installation

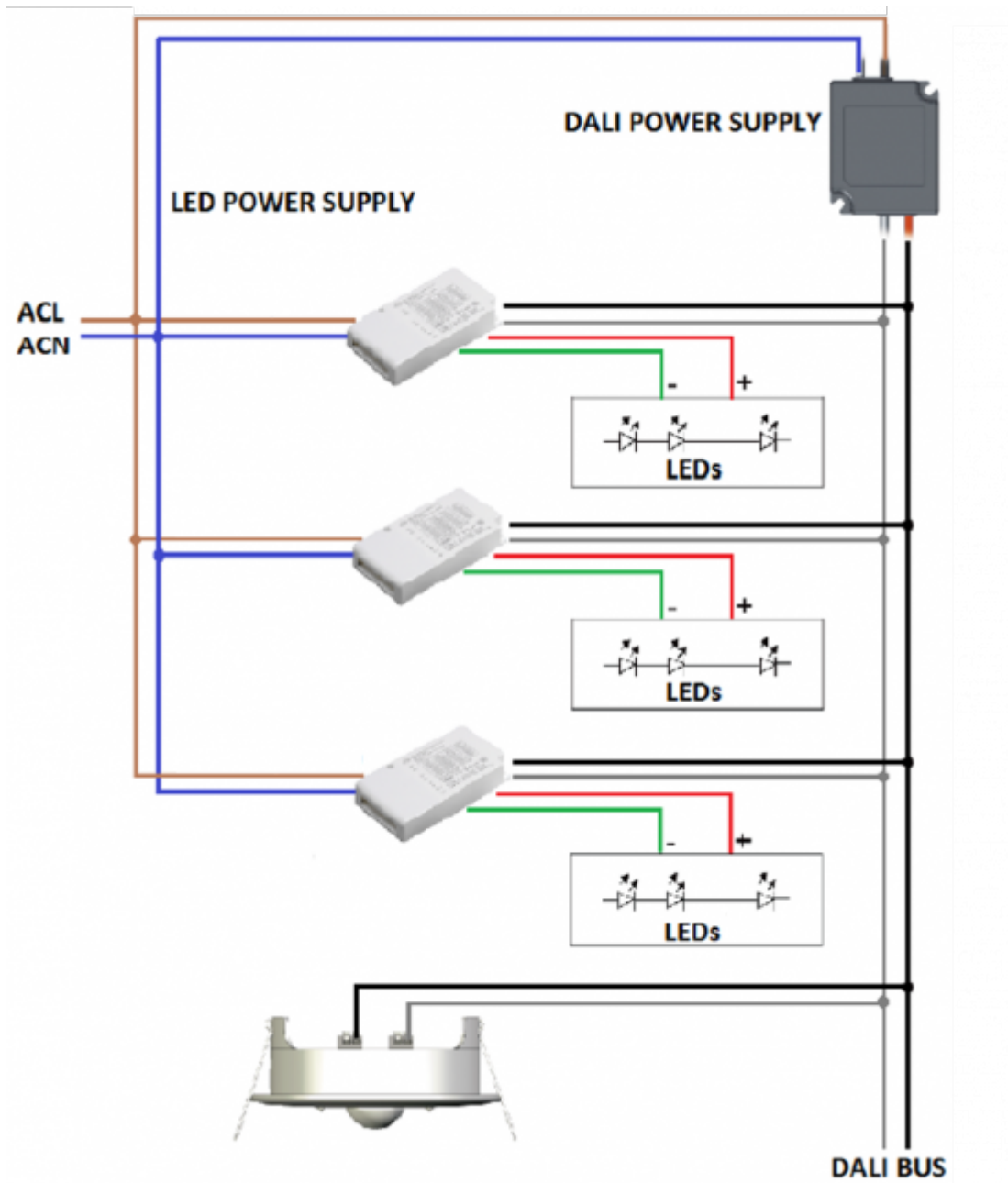

Settings

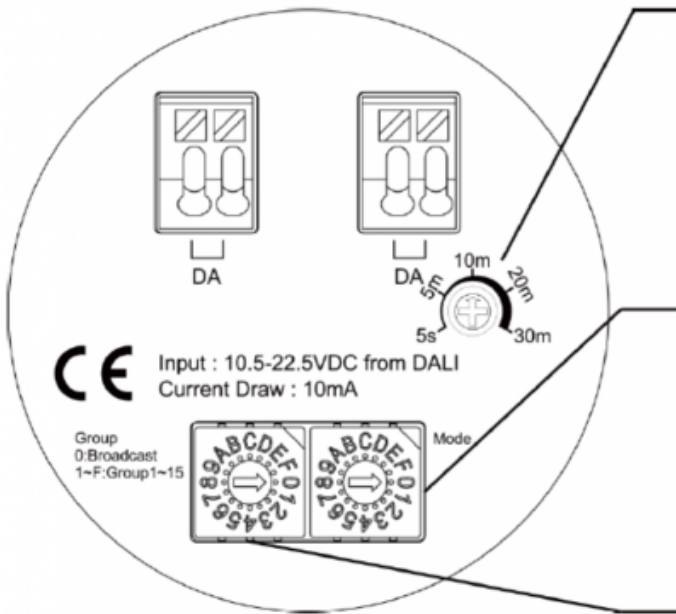

Time

Delay Time 5secs-30mins



Mode Illuminance Sensor-Based

0	ON:100% → MIN: 1% → OFF	8	ON: 100% → MIN: 1%
1	ON:100% → MIN: 5% → OFF	9	ON: 100% → MIN: 5%
2	ON:100% → MIN:10% → OFF	A	ON: 100% → MIN: 10%
3	ON:100% → MIN:20% → OFF	B	ON: 100% → MIN: 20%
4	ON: 70% → MIN: 1% → OFF	C	ON: 70% → MIN: 1%
5	ON: 70% → MIN: 5% → OFF	D	ON: 70% → MIN: 5%
6	ON: 70% → MIN:10% → OFF	E	ON: 70% → MIN: 10%
7	ON: 70% → MIN:20% → OFF	F	ON: 70% → MIN: 20%

Group

0: Broadcast, 1-F: Group1~15

Note:

1. Group 1 represents the Group 0 in the DALI standard.
2. A sensor under Broadcast Mode should not be on the same DALI bus with a sensor under Group Mode.

0	1	2	3	4	5	6	7
Broadcast	Group1	Group2	Group3	Group4	Group5	Group6	Group7
8	9	A	B	C	D	E	F
Group8	Group9	Group10	Group11	Group12	Group13	Group14	Group15

Note: Group 1 represents the Group 0 in the DALI standard

From:
<http://wiki.hiq-universe.com/> -

Permanent link:
http://wiki.hiq-universe.com/doku.php?id=en:ms_main:ir-c12d-lc&rev=1606057427

Last update: **2020/11/22 15:03**

