

Smart WiFi thermostat

Smart WiFi thermostat



Model number:	TH-W-01B
Mounting:	In-wall flush box
Dimensions:	86×86×40 mm

Applications

- room / zone WiFi thermostat

Features

- cooling
- fan options:
 - 3 speed
 - hand/auto
 - weekly
- on/off valve control

General description

Can be used for any heating and/or cooling system including with fan-coils. TH series provide maximum comfort and energy saving functionality. Set-points are selectable on the unit or through other devices. Advanced functionality including smart-phone operation, internet operation, scheduling, HIQ automations, automatic weather response and more are provided when connected to HIQ Home Controller and HIQ universe.

Technical specification

Power supply:	95-240V,50/60Hz
Ingress protection:	IP20
Operating temperature:	0..55°C
Storage temperature:	-20..75°C
Relative humidity:	0..95% n/c
Installation box:	EU 60 Round box or 86 Box

Terminals

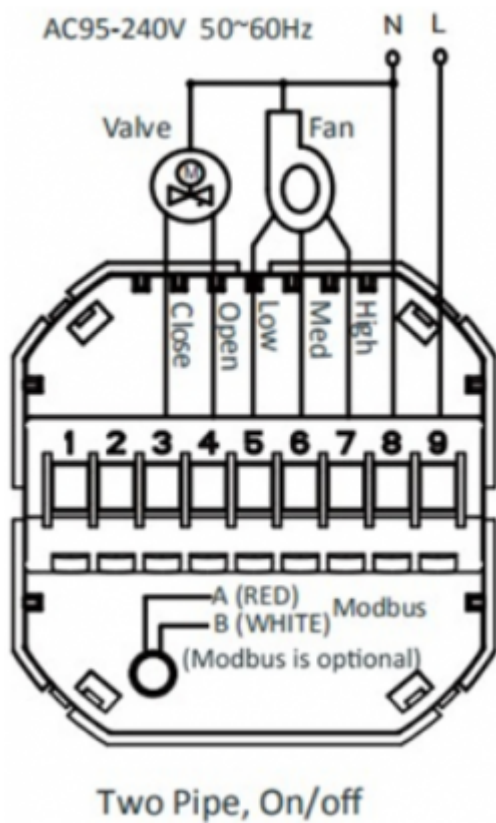

Wi-Fi enabled

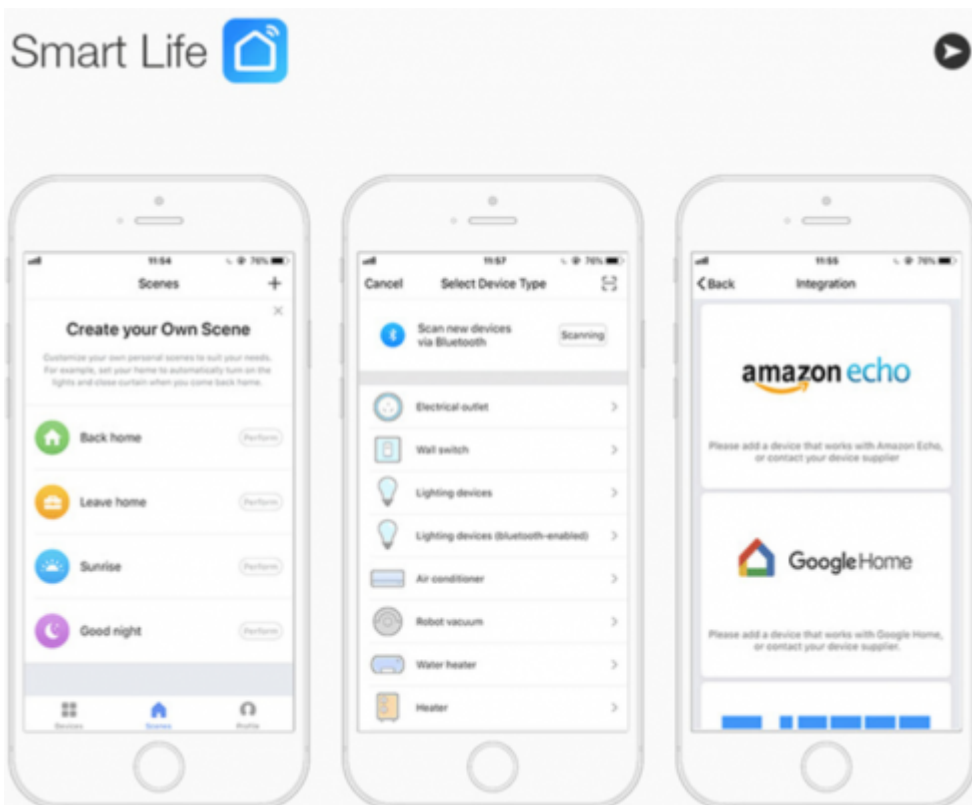

From:

<http://wiki.hiq-universe.com/> -

Permanent link:

http://wiki.hiq-universe.com/doku.php?id=en:ms_main:th-w-01b&rev=1620718978

Last update: **2021/05/11 07:42**

