

TVOC, Temperature and Humidity Sensor



Model number:	RB-100-TVOC-TH
Mounting:	In-wall, dose
Dimensions:	85 x 116 x 44 mm
Connection:	RS485 to HIQ MC controller or Cybro
Frame color:	Black

Applications

- HVAC and indoor air monitoring
- Widely used in building automation
- Climate, and HVAC signal collection

Features

- High measurement accuracy
- Built-in high-performance microprocessor
- Multiple probes available
- Superior performance and long-term stability

Technical specifications

Power supply:	10-30VDC Note: 0-10VDC output (limited to 24VDC Power Supply)
Signal output:	4-20mA/0-5VDC/0-10VDC RS485 output (Modbus protocol)
Digital output:	Device address 1-255, default 1

	Device baud rate 2400, 4800, 9600 optional, default 4800
	Byte format 8-bit data bit, 1 stop bit, no parity
CO2 Measuring	0-100ppb
Equivalent CO2	400-5000ppm
Measuring temperature	-40°C to +80°C
Measuring humidity :	Relative humidity 0%-100% RH
Temperature accuracy :	0.5°C (25°C)
Humidity accuracy :	3% RH (5%RH-95%RH, 25°C)
Long-term stability :	Temperature < 0.1°C/year, Humidity <0.1%RH/year
Response time :	CO2 90% of the change in 2min, Temperature <18sec, Humidity < 6sec

Wiring

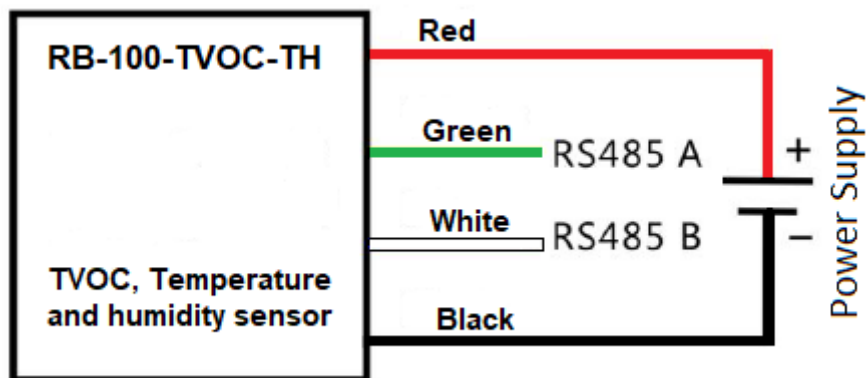

Dimensions

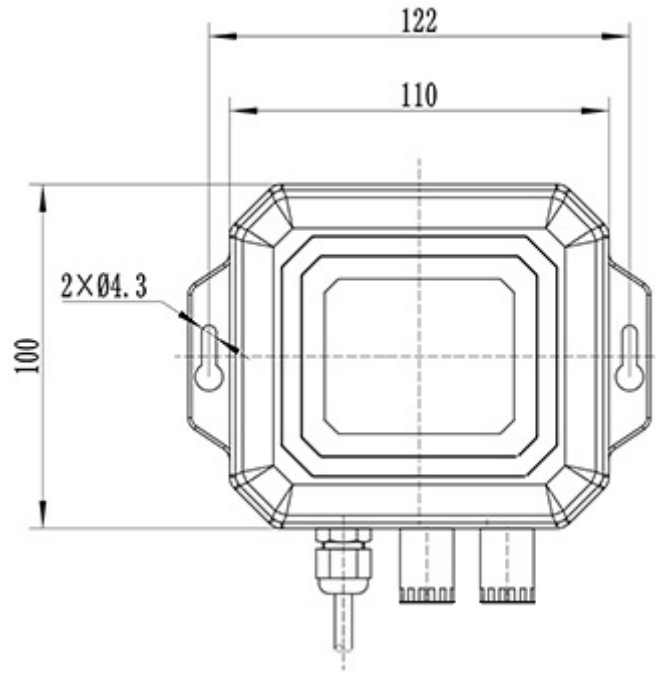

From: <http://wiki.hiq-universe.com/> -

Permanent link: http://wiki.hiq-universe.com/doku.php?id=tvoc_temperature_and_humidity_sensor&rev=1673508892

Last update: **2023/01/12 07:34**

