

HEMS v1.2.0 Introduction

Home Energy Management System (HEMS) is a system for:

- monitoring electricity flows at home (consumption, production, and storage),
- control of key consumers,
- optimizing consumption in terms of reducing consumption and using cheaper energy to ensure the same comfort with lower costs,
- current limiting of consumers to protect main grid fuse,
- managing charging of electric vehicles (EV fleet)

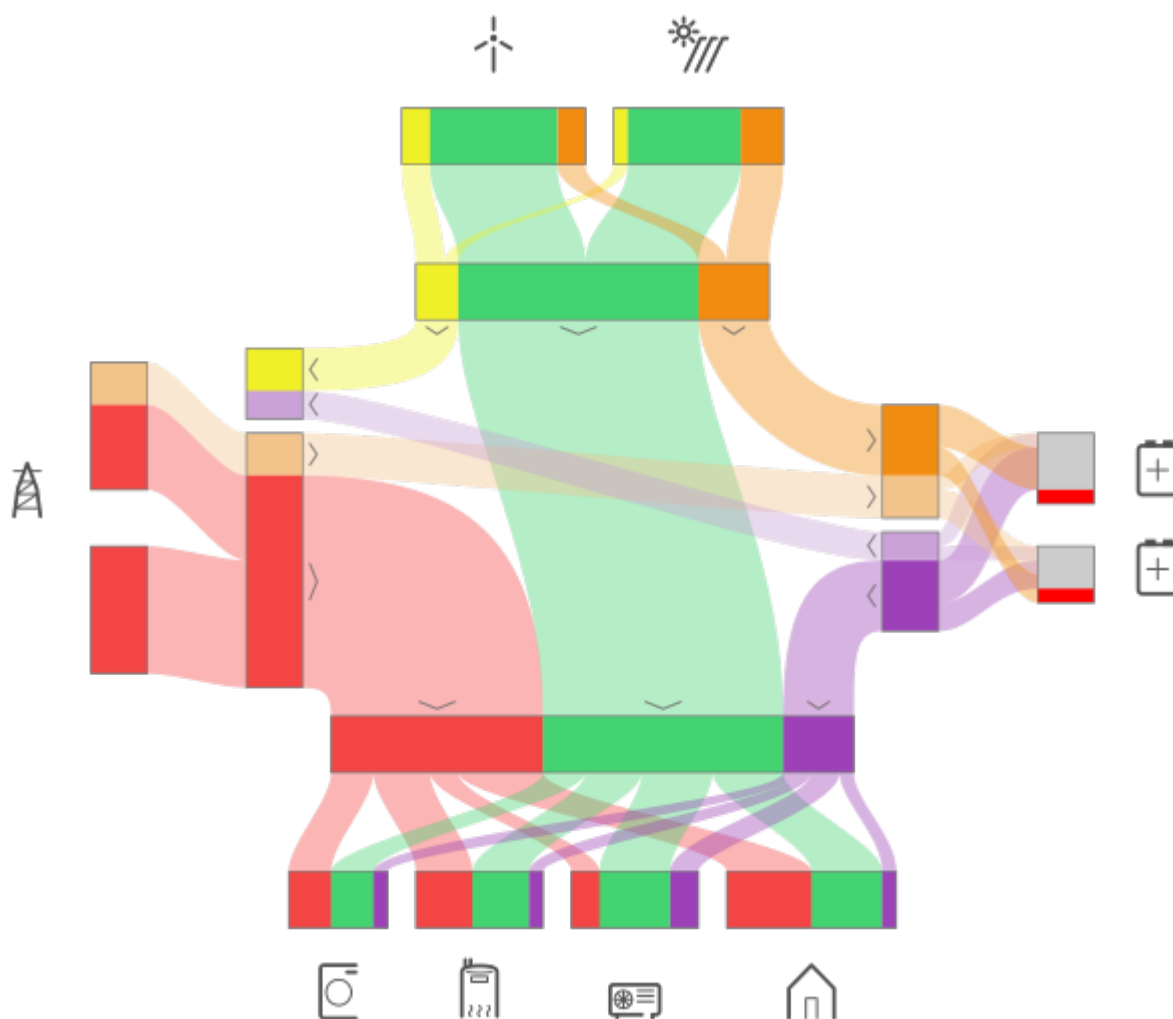

HEMS Controller

It consists of an HEMS master controller ([MC-230](#)).

Temperature sensor

Temperature sensor is directly wired ([Digital temperature sensor](#)) or paired ([Wireless temperature sensor](#) and [Wireless temperature and humidity sensor](#)) to HEMS master controller [MC-230](#). Only one temperature sensor can be added.

Power sensors

The measurement of electrical power and energy of all energy sources and main electrical consumers is provided by single-phase ([PM1-E-D](#)) and three-phase ([PM3-I-D](#) and [PM3-E-D](#)) power sensors which are connected directly to HEMS master controller [MC-230](#). It supports:

- **1 grid** power sensor
- up to **3** sensors for local power **plants** (PV, Wind, Cogeneration, Generator, etc)
- up to **2** local **storage** systems (home battery)
- up to **8** managed **consumers** (electrical heating, ev charging station, electrical water heater, washing machine, tumble dryer, ...)

The measurement of main electrical consumers is also possible with wireless modules ([Metering smart plug](#) and [Micro smart plug](#)) which are paired to HEMS master controller [MC-230](#). It supports up to **8** managed **consumers**.

Power relays

Are used for control of managed consumers. Power relays are toggling power supply or enabling signals for the operation of the device. They are controlled directly from HEMS master controller [MC-230](#).

Push buttons

Are used for manual control of managed devices. Push buttons are directly wired or paired ([Soft remote](#)) to HEMS master controller [MC-230](#).

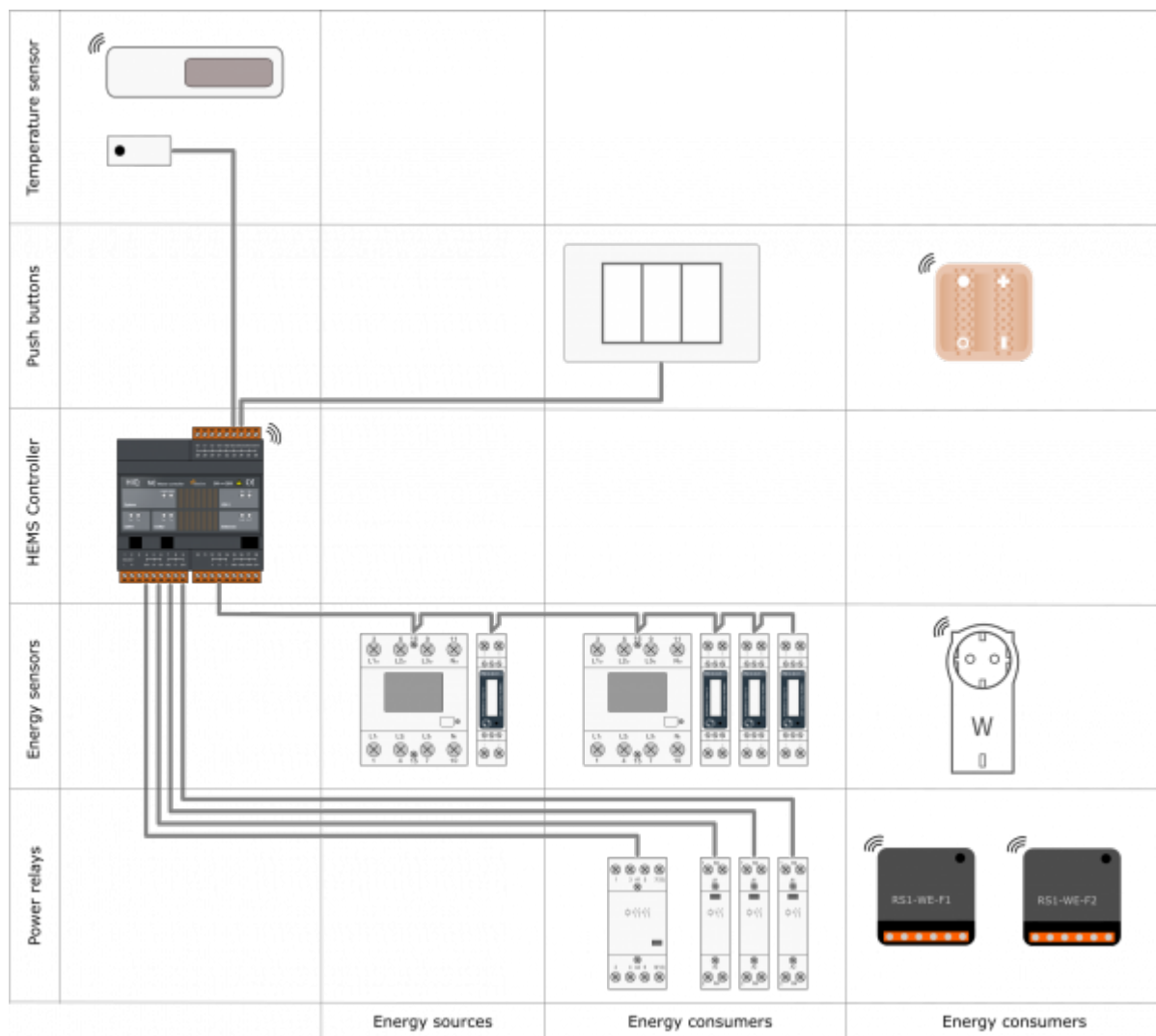

EV chargers

Are used for charging electric vehicles. They are controlled from HEMS master controller [MC-230](#) via Modbus TCP/IP gateway.



SAFETY INSTRUCTIONS

Use the following safety guidelines to ensure your own personal safety and to protect your equipment and working environment from potential damage.

NOTICE: All applicable local and national codes that regulate the installation and operation of the equipment must be strictly followed.

NOTICE: Installation and electrical connection of the equipment must be carried out by qualified and authorized personnel.

Notices which require special attention are highlighted with following symbols:

-  **WARNING** - which indicates that death, severe personal injury or substantial property damage can result if proper precautions are not taken.
-  **CAUTION** - which indicates that minor to medium personal injury or property damage can result if proper precautions are not taken.

This product can only function correctly if it is transported, stored, set up and installed correctly, and operated and maintained as recommended according to manufacturer's instructions.



WARNING: Failure to comply with manufacturer's safety and installation instructions or applicable codes and standards can result in damage to equipment or serious injury to personnel.



WARNING: Before installing, servicing or repairing electrical equipment power source must be disconnected.



CAUTION: Don't try to open the device, any interference or change may impact device's properties and significantly affect safety.

- The device must be installed inside electrical enclosure where it cannot endanger people or environment.
- During operation, device must not be exposed to high temperature, high humidity, excessive dust, corrosive gases, vibration or shock.
- All connected wires must comply with manufacturer's specifications.
- For installation use only tools and equipment with non-conducting handles.
- Sufficient ventilation space has to be assured around device for proper operation.
- The manufacturer does not undertake any liability for material or personal damage resulting from use or handling which is not in accordance with the manufacturer's safety instructions.

Master Controller

Advanced Controller

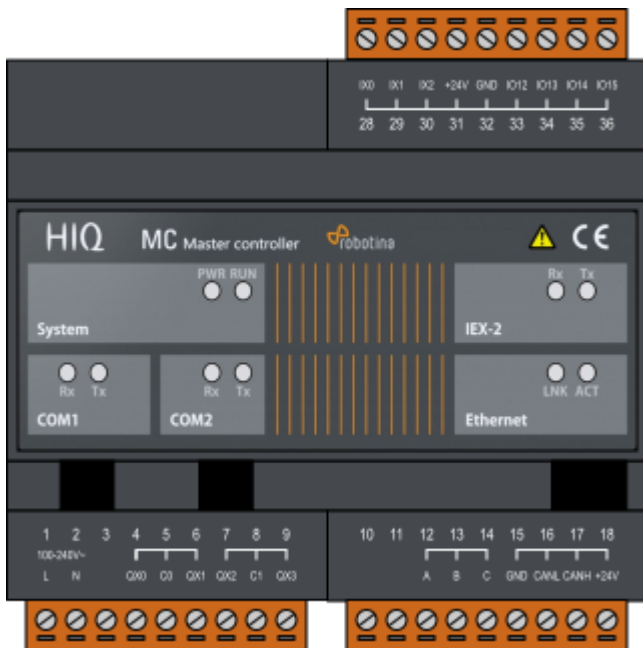

Model number:	MC-230-01	230 VAC, 11 IO, Enocan, 2 × RS232, RS485, IEX2 terminals
	MC-230-02	230 VAC, 11 IO, 2 × RS232, RS485, IEX2 terminals
	MC-230-03	230 VAC, 11 IO, Enocan, 2 × RS232, isolated RS485, IEX2 terminals
	MC-230-04	230 VAC, 11 IO, 2 × RS232, isolated RS485, IEX2 terminals
Mounting:	DIN rail (35mm), 6M, 106mm	
Dimensions:	106x108x58mm	

Features

- 3 digital inputs
- 4 relay outputs 8 A
- 4 universal inputs/outputs
- Ethernet, USB, IEX-2, 2×RS232, 1×RS485 (optional isolated)
- Enocan gateway (optional)
- 230 VAC power supply

Safety standards

EN 61010-1, EN 61010-2-201, EN 61131-2

Technical specification

Relay outputs:	8A/250VAC resistive, 8A/30VDC resistive
Communication:	Ethernet, 2x RS232, 1x RS485, IEX-2 bus
Nominal power rating:	230 VAC
Power consumption:	typ. 1W (no load), 10W max
Power output:	24V 200mA (IEX-2 + terminals)
Ingress protection:	IP20
Operating temperature:	0..50°C
Storage temperature:	-20..75°C
Relative humidity:	0..85% n/c
Input type(ix00..ix02):	dry contact, internal pull-up 12V 2mA
Cable lenght:	50m
COM1 type	RS485 two wire
Transmit/receive	automatic switching

Terminals

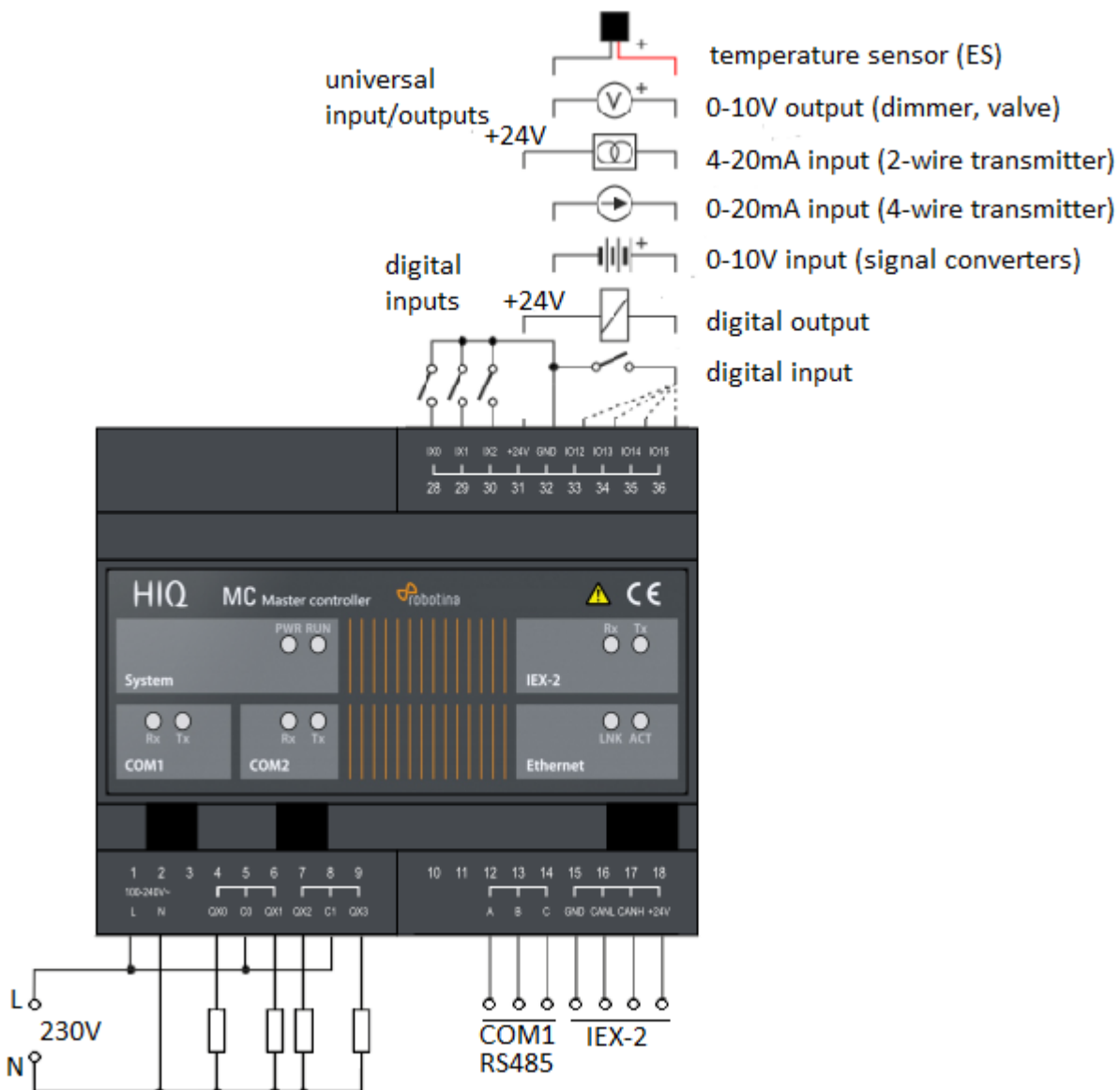

Three phase power sensor, CT

3-phase power-sensor, current transformer



Model number:	PM3-E-D-CT
Connect to:	MC-230
	RS485 power sensor bus A - B
Mounting:	DIN rail, 1M, 18 mm
Dimensions:	65 × 72 × 94,5 mm
Used for measuring power and energy of	
✓	single/three-phase energy sources
✓	single/three-phase energy consumers

Applications

- Digital multi-function power sensor for single/three phase networks

Features

- DIN rail mounting with 3x 50A (or 1x 50A) current transformer
- Line voltage and THD% (total harmonic distortion) of all phases
- Line Frequency
- Currents, Current demands and current THD% of all phases
- Power, maximum power demand and power factor
- Active energy imported and exported
- Reactive energy imported and exported

General description

The unit measures and displays the characteristics of three phase four wires(3p4w) supplies, including voltage, frequency, current, power, active and reactive energy, imported or exported. Energy is measured in terms of kWh, kVArh. Maximum demand current can be measured over preset periods of up to 60minutes. In order to measure energy, the unit requires voltage and current inputs in addition to the supply required to power the product. The requisite current input(s) are obtained via current transformers (CT). This power sensor can be configured to work with a wide range of CTs with 0.33V

output, giving the unit a wide range of operation. Built-in interfaces provide pulse and RS485 Modbus RTU outputs. Configuration is password protected. This power sensor can be powered from a separate auxiliary (AC or DC) supply. Alternatively, it can be powered from the monitored supply, where appropriate.

Technical specifications

Technical Data	
Operating Humidity	≤ 75%
Storage Humidity	≤ 95%
Operating Temperature	-25°C - +50°C
Storage Temperature	-40°C - +70°C
Mounting	DIN rail (DIN 43880)
Sealing	IP51 Indoor
Auxiliary supply voltage	Nominal ± 1%
Auxiliary supply frequency	Nominal ± 1%
Frequency	50Hz or 60Hz(±2%)
Power Consumption	≤ 10W
Accuracy	
Voltage, Current	0.5%
Frequency	0.2% of Mid-Frequency
Power Factor	1% of Unity (0.01)
Active Power, Apparent Power	± 1% of Range Maximum
Reactive Power	± 1% of Range Maximum
Reactive Energy (Varh)	± 1% of Range Maximum
Active Energy (Wh)	Class 1 IEC 62053-21
Current transformer	
Frequency	50-60 Hz
Rated current	50 A
Accuracy	from 20% to 120% of rated current
Phase angle	less than 2 degrees at 50% of rated current
Insulation voltage	600 VAC
Maximum primary voltage	5000 VAC (insulated conductor)
Dielectric strength	2.5 kV/1mA/1min
Operating temperature	-15 to 60°C
Operating humidity	< 85 %
Case material	PC/UL94-V0
Bobin	PBT
Core	Permalloy
Internal structure	Epoxy
Leads	UL 1015, Twisted pair, 22 AWG
Modbus	
Bus Type	RS485 (Semi-Duplex)
Protocol	Modbus RTU
Baud Rate	1200/2400/4800/9600bps
Address Range	1-247

Max. Bus Loading	64pcs
Communication Distance	1000 Meters
Parity	EVEN/ODD/NONE
Data Bit	8
Stop Bit	1

Dimensions

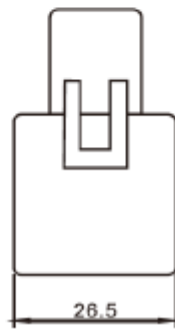
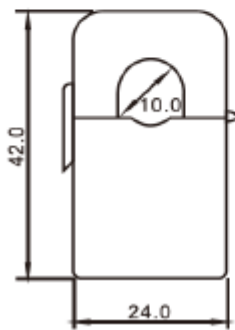
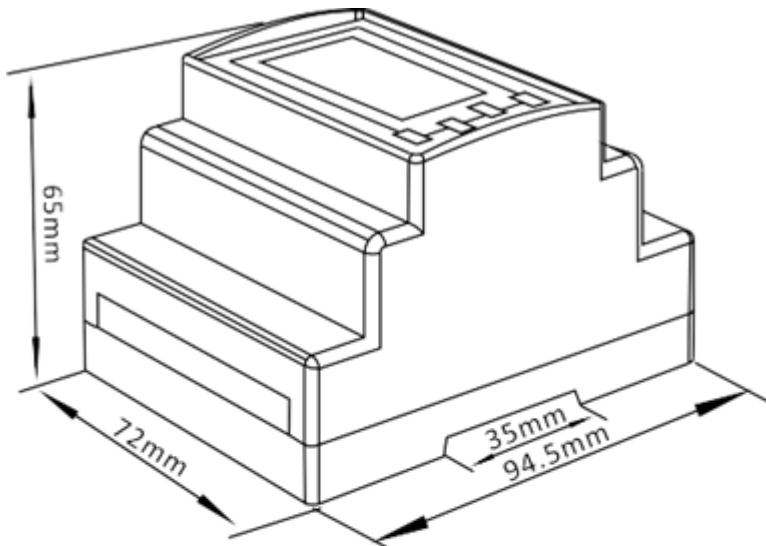

Installation

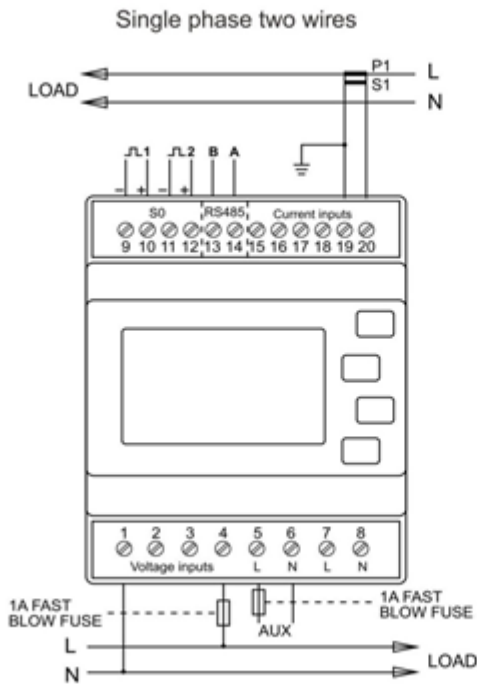
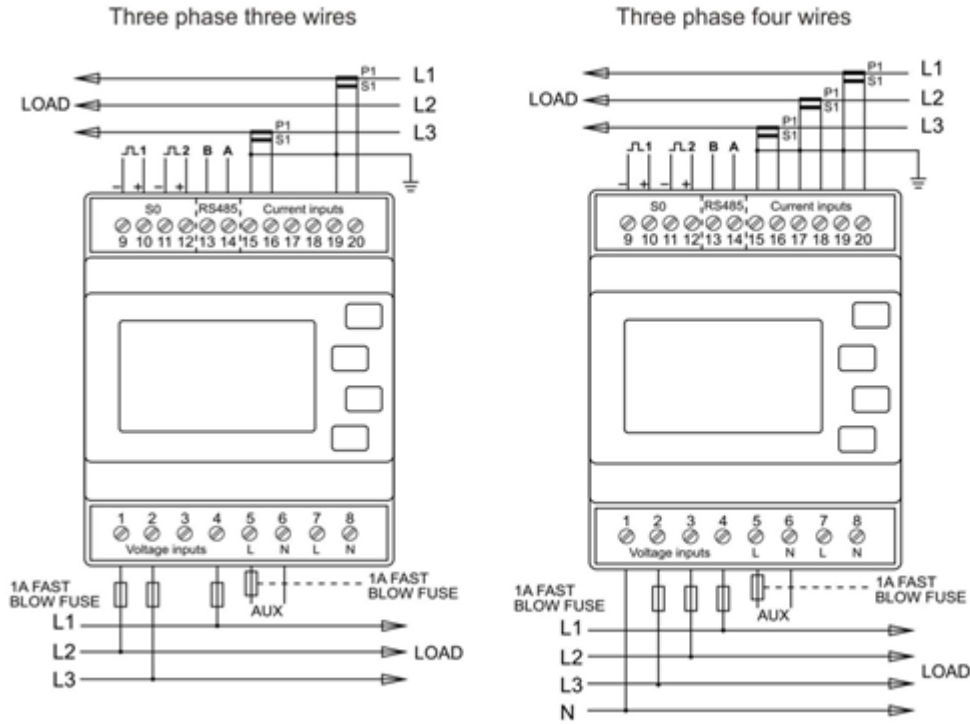

hiq_pm3-e-d-ct_user_manual_v1.pdf
 hiq_pm3-e-d-ct_protocol_v1.6.pdf

Single phase power-sensor, CT

1-phase power-sensor, current transformer

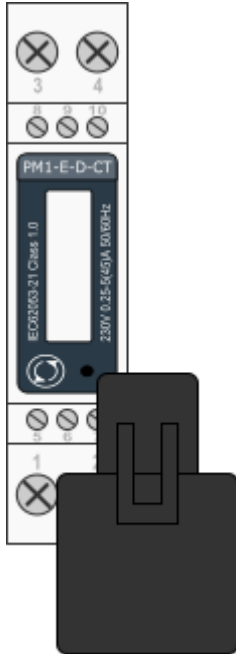

Model number:	PM1-E-D-CT
Connect to:	MC-230
	RS485 power sensor bus A - B
Mounting:	DIN rail, 1M, 18 mm
Dimensions:	18 × 62 × 119 mm
Used for measuring power and energy of	
✓	single-phase energy sources
✓	single-phase energy consumers

Applications

- Digital multi-function power sensor for single phase networks

Features

- DIN rail mounting with 50A current transformer
- Compact design in a single module 18mm wide
- Seal-able cover(phase and neutral terminals)

General description

The PM1-E-D series is an advanced single phase energy monitoring solution with built-in configuration push button and LCD data displaying, particularly indicated for active energy and other parameters metering and for cost allocation. Housing for DIN-rail mounting, IP51 protection degree.

Technical specifications

Technical Data	
Operating Humidity	≤ 75%

Storage Humidity	≤ 95%
Operating Temperature	-20°C - +50°C
Storage Temperature	-30°C - +70°C
International Standard	IEC 62053-21
Accuracy	Class 1
Mounting	DIN rail (DIN 43880)
Sealing	IP51 Indoor
Nominal Voltage Input	(Ph+N) 230V AC (176-276V AC)
Max Continuous Voltage	120% of nominal
AC Voltage Withstand	4KV for 1 minute
Impulse Voltage Withstand	6KV-1.2μS
Current Input	0.25-5A(6)A AC RMS
Operational Current Range	0.4% Ib-I _{max}
Over current withstand	20I _{max} for 0.01s
Nominal Input Current Burden	0.5VA
Frequency	50Hz(±10%)
Power Consumption	≤ 2W/10VA/phase
Accuracy	
Voltage, Current	0.5%
Frequency	0.2% of Mid-Frequency
Power Factor	1% of Unity (0.01)
Active Power, Apparent Power	≤ 1% of Range Maximum
Reactive Power	≤ 1% of Range Maximum
Reactive Energy (Varh)	Class 2
Active Energy (Wh)	Class 1
Current transformer	
Frequency	50-60 Hz
Rated current	50 A
Accuracy	from 20% to 120% of rated current
Phase angle	less than 2 degrees at 50% of rated current
Insulation voltage	600 VAC
Maximum primary voltage	5000 VAC (insulated conductor)
Dielectric strength	2.5 kV/1mA/1min
Operating temperature	-15 to 60°C
Operating humidity	< 85 %
Case material	PC/UL94-V0
Bobin	PBT
Core	Permalloy
Internal structure	Epoxy
Leads	UL 1015, Twisted pair, 22 AWG
Modbus	
Bus Type	RS485 (Semi-Duplex)
Protocol	Modbus RTU
Baud Rate	1200/2400/4800/9600bps
Address Range	1-247
Max. Bus Loading	64pcs

Communication Distance	1000 Meters
Parity	EVEN/ODD/NONE
Data Bit	8
Stop Bit	1

PM1-E-D-CT Terminals

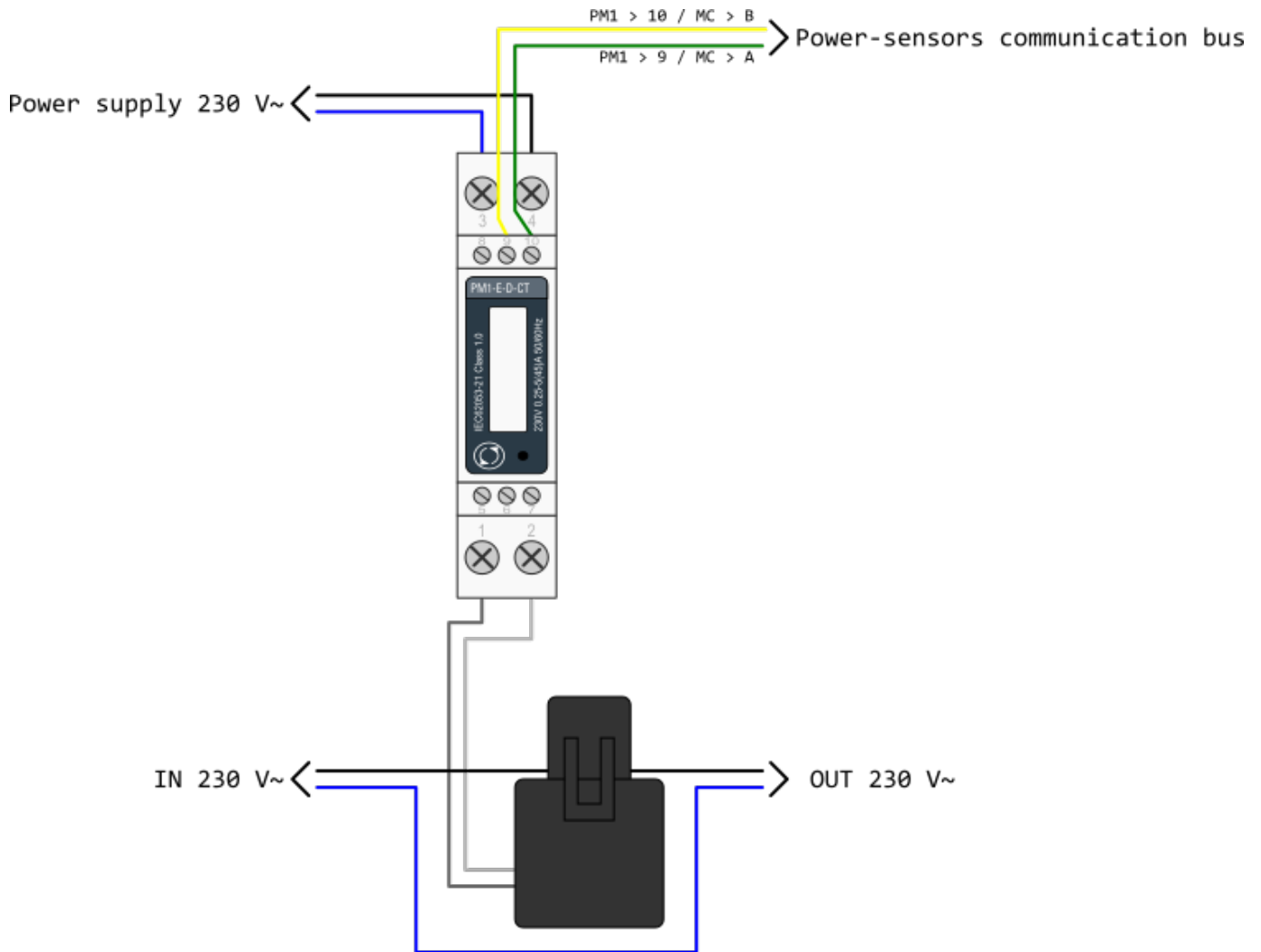

hiq_pm1-e-d-ct_user_manual_2020_v1.0.pdf
 hiq_pm1-e-d-ct_protocol_v1.2.pdf

Smart plug

Enocean wireless smart plug



Model number:	SCO-WE-F - Schuko (German) SCO-WE-E - Type E (French)
Mounting:	In-field; power outlet
Dimensions:	104 × 51 × 36mm
Connection:	Wireless Enocean
	MC-230-01
	MC-230-03
	MC-24-01
	MC-24-03
	MC-24-05

- Smart Actuator
- High power capacity
- Ergonomy

Technical specifications

Power:	230V AC 50Hz (EU) / 110V AC 60Hz (US)
Max switching capacity:	3.000W (Continuous)
	3.680W (Temporary) on resistive load
Self consumption:	< 1W
EEP (EnOcean Profile):	EEP D2-01-0A
Range:	Up to 30m indoor
Wireless repeater:	Yes
Dimension:	104 × 51 × 36mm

Certifications and standards

Europe

- EN61058-1 :2002+A2 :2008
- NF C 61-314 :2008+A1 :2010 (Type E)
- DIN VDE 0620 -1: 2013 (Schuko)
- DIN VDE 0620 -2-1: 2013 (Schuko)
- EN301489-1 V1.9.2
- EN301489-3 V1.6.1
- EN300220-2 V2.4.1

Micro smart plug

Enocean wireless micro smart plug with metering



Model number:	SMM-WE-F - Schuko (German) SMM-WE-E - Type E (French)
Mounting:	In-field; power outlet
Dimensions:	41 × 73 mm
Connection:	Wireless Enocean MC-230-01 MC-230-03 MC-24-01 MC-24-03 MC-24-05

- Smart Actuator
- Metering
- High power capacity
- Ergonomic

Technical specifications

Power:	230V AC 50Hz (EU)
Max switching capacity:	1.840 W on resistive load
Metering	power [W] and energy [Wh]
Self consumption:	< 1W
EEP (EnOcean Profile):	EEP D2-01-0E
Range:	Up to 30m indoor
Wireless repeater:	Yes
Dimension:	41 × 73 mm

Certifications and standards

Europe

- EN61058-1 :2002+A2 :2008
- NF C 61-314 :2008+A1 :2010 (Type E)
- DIN VDE 0620 -1: 2013 (Schuko)
- DIN VDE 0620 -2-1: 2013 (Schuko)
- EN301489-1 V1.9.2
- EN301489-3 V1.6.1
- EN300220-2 V2.4.1

Temperature and humidity sensor

Enocean wireless temperature and humidity sensor



Model number:	TSH-WE-W1
Mounting:	In-field; on wall
Dimensions:	80 × 26 × 18 mm
Connection:	Wireless Enocean to MC-230-01

- No battery
- Wireless
- Easy to mount
- Discreet
- Optional battery

Technical specifications

Power:	Solar panel
- optional:	battery CR1216, 3 years
Metering	0 to 40°C (0.16°resolution)
	0 to 100% RH - Indoor use
Self consumption:	< 1W
EEP (EnOcean Profile):	EEP - A5-04-01
Range:	Up to 30m indoor
Dimension:	80 × 26 × 18 mm

Certifications and standards

Europe

- EN 60950-1: 2006+A11:2009
- +A1:2010+A12:2011+A2:2013
- EN301489-3 V1.6.1
- EN 61000-3-2:2013,
- EN 61000-3-3:2013
- EN 300220-2 V3.1.1
- EN 62479:2010

USA

- FCC & IC Rules

Relay Switch

Wireless relay switch, 1 channel



Model number:	RS1-WE-F1
Mounting:	In-field; flush box
Dimensions:	40 x 44 x 16.9 mm
Connection:	Wireless Enocean
	MC-230-01
	MC-230-03
	MC-24-01
	MC-24-03
	MC-24-06

- High switching capacity
- Ultra low profile
- Potential-free input
- Remote commissioning

Technical specifications

Power supply:	230 V AC ~ 50 Hz
Switching capabilities:	230 V AC - 10A / 30 V DC - 10 A
Consumption:	<1W
Maximum output power:	2,3 kW (resistive load)
Radio frequency range:	868,0 to 868,6 MHz
RF power max:	+3dBm
Range:	Up to 30m indoor
Wireless repeater:	Yes
Operational temperature:	0°C to 40°
Protection rating:	IP 2X
Pairing:	up to 22 controllers
EEP (EnOcean Profile):	D2-01-0F
Dimensions :	40 x 44 x 16.9 mm

Certifications and standards





Europe

- EN60669-1:1999+A1:02+A2:08
- EN60669-2-1:2004+A1:09+A12:10
- EN300220-2 V3.1.1
- EN301489-01 V2.1.1
- EN301489-03 V2.1.1
- EN62479:2010

rs1-we-f1_user_manual.pdf

Temperature sensor

Digital temperature sensor

Technical specifications	
Operating temperature range	-55°C to +100°C (0°C to +50°C for -W)
Measuring error	max. ±2°C (-55°C to +100°C)
	max. ±0.5°C (-10°C to +85°C)
	typ. ±0.2°C (-10°C to +85°C)
Connect to	MC-230
	terminals GND - IO12
	for ES-B connect red and black to GND and yellow to IO12
Order code	
ES	heat-shrink tubing, 2m wire
	
ES-A	aluminum housing IP 67, 5m wire
	
ES-W-OW-WHITE	white plastic housing, terminals
ES-W-OW-IVORY	ivory plastic housing, terminals
	
ES-B	steel tube housing IP 67, 2m wire
	

Commissioning

Mounting

Mount the main controller MC-230, PM1-E-D, PM3-E-D and PM3-I-D electricity sensors, fuses, power relays, and push-buttons to a suitable location.

Wiring

Wire all elements **except** communication with **PM1-E-D** and **PM3-E-D** sensors.

Connect the MC-230 to the home LAN.

Configuration

Install and run [HEMS Configurator](#) on your PC.

Go to the “**settings**” page.

With the “**autodetect**” button, the application will locate the controller in the local network.

Enter **names**, select **icons** for all sources and consumers.

Power-sensor adding

One-phase sensor PM1-E-D

- **Connect** communication bus (to only one power-sensor)
- In HEMS Configurator counter should appear as “new device”
- Press and hold the push-button on the power-sensor until it appears **-SEt-** on display
- In HEMS Configurator click on the “ **add**” button next to the source or consumer that the sensor is measuring

Three-phase sensor PM3-E-D

- **Connect** communication bus (to only one power-sensor)
- In HEMS Configurator counter should appear as “new device”
- Click on the “ **add**” button next to the source or consumer that the sensor is measuring

Three-phase sensor PM3-I-D

- Communication bus with the power-sensor should already be connected
- Press and hold the push-button on the sensor until it appears **“CONf Add”** on display
- In HEMS Configurator counter should appear as “new device”
- Click on the **“add”** button next to the device that the sensor is measuring

Without grid power meter

- **Virtual grid PM** is an option if no grid meter is used. Power, current and energy will be calculated from other power meters.

Power-sensor removing

One-phase sensors PM1-E-D

- Make sure the “new device” is empty
- Press the button on power-sensor until **-Set-** appears on the display
- In HEMS Configurator press **“del”** button next to the sensor
- After a few seconds, the sensor should appear as the “new device”
- If desired, the sensor can be removed or it can be assigned to another device

Three-phase power-sensor

- Make sure the “new device” is empty
- In HEMS Configurator press **“del”** button next to the sensor
- After a few seconds, the sensor should appear as the “new device”
- If desired, the sensor can be removed or it can be assigned to another device

Power plant connection¹

The power plant can be connected to the grid in two ways:

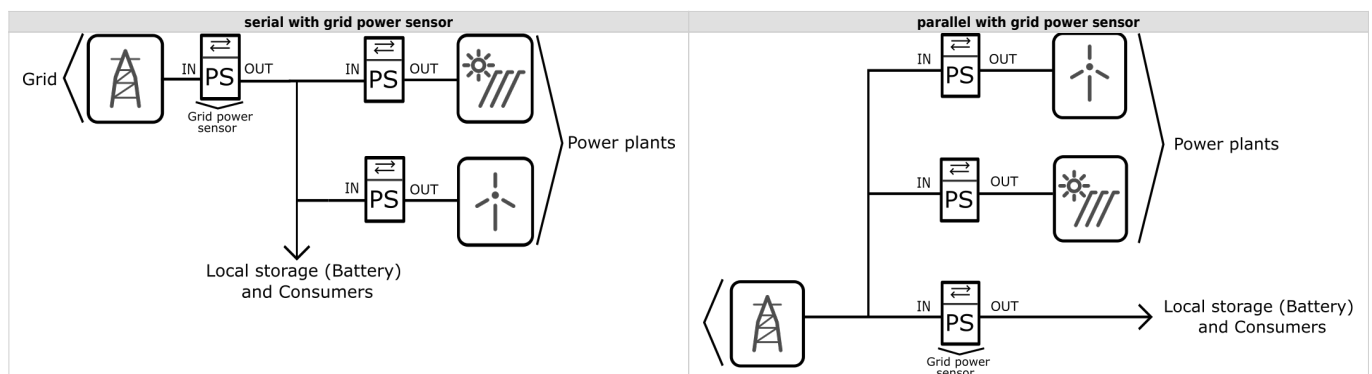

When configuring the power plant, select

- **in:** serial with grid power sensor
- **ex:** parallel with grid power sensor

In HEMS Configurator by default, the power plant is connected in series.

Wireless setting

Enable the wireless setting to add, delete, or set repeater level wireless modules.

Wireless module adding

Temperature and humidity sensor

- Launch the pairing by the press on the learning button on the back of the device.
- The wireless sensor is added in the HEMS Configurator.

Micro smart plug and Smart plug

- Launch the pairing by the press on the button for 2 seconds until the LED becomes red. Release the button, the LED will then glow in red
- To confirm that the pairing is OK, the LED will blink in green
- In the HEMS Configurator module should appear as “new device”
- Click on the “ **add**” button next to the consumer that is connected to the module

Relay switch-1 channel

- Launch the pairing by doing 3 consecutive presses on the relay switch button. The LED blinks red
- To confirm that the pairing is OK, the LED will blink green twice
- The HEMS Configurator module should appear as a “new device”
- Click on the “ **add**” button next to the consumer that is connected to the module

Relay switch-2 channel

- Launch the pairing by doing 3 consecutive presses on the relay switch button. The LED blinks red
- To confirm that the pairing is OK, the LED will blink green twice
- In the HEMS Configurator the module first channel should appear as a “new device”
- Click on the “ **add**” button next to the consumer that is connected to the modules first channel
- In the HEMS Configurator the module second channel should appear as a “new device”
- Click on the “ **add**” button next to the consumer that is connected to the modules second channel
- Before you pair a new device both channels must be added to the consumers

Wireless module removing

Micro smart plug, smart plug and relay switch-1 channel

- In the HEMS Configurator press “**del**” button next to the consumer connected to the module you want to remove
- After a few seconds the module is removed

Relay switch-2 channel

- In the HEMS Configurator press “**del**” button next to the consumer connected to the channel module you want to remove
- After a few seconds, deleted channel of a module should appear as a “new device”
- We can remove the module by deleting the second channel or the deleted channel can be assigned to another consumer

Setting repeater level

When enabling repeater mode, the wireless module can repeat a message not addressed to him, and increase range by creating network grid between all wireless devices.

The repeater can be configured to level 0 (off), level 1 (one hop), or level 2 (two hops):

- **Level 0:** gateway — module.
- **Level 1:** gateway — repeater — module.
- **Level 2:** gateway — repeater — repeater — module².

By default, the repeater mode is disabled (level 0). If you want to change the repeater mode press icon «» in the **output** in **Consumers settings table**.

Setting device management features

For each managed consumer we can set:

- **sub:** mark device as submeter if device is not part of internal network. Energy division for this device will be ignored.
- **man. time:** the time is in minutes for the manual override. It serves to ensure that the user can ensure a minimum validity of the manual switchover.
- **out mode:** it can be normal (the output is turned on means the device is working) or inverted (the device is working when the output is off).
- **timetable checkbox:** allows to enable or disable the timetable for each device.

Enable power-sensor from compatible systems

HEMS will automatically detect compatible

- battery systems **eStore** and
- home automation systems **HIQ Home**

which are in the same local network.

Only the first system is detected, if there is more than one it is necessary to enter the serial number of the desired system manually.

if **eStore** is **enabled**, HEMS will read:

- **grid** power-sensor
- power-sensor for the **first PV Plant** and
- power-sensor of the **first storage** system

From the **enabled HIQ Home** system, HEMS will automatically read the **grid** power-sensor.

Internet access

If enabled, the system will automatically establish access to the HIQ Universe web service. Communication with the server is automatically established so that the controller sends the push message to the server, and the server can then access the controller on the given path. The UDP type of internet packets on the output port 8442 is used. If communication is not established automatically, check the access from the local network to the Internet and the router settings.

Permanent memory

Saving parameters to the permanent memory, after changing the settings, is necessary since at startup HEMS always reads parameters from the permanent memory.

Backup / restore to PC

HEMS Configurator allows you to backup and restores all parameters to PC.

¹ Only for the first power plant

² Both repeaters must be set to level 2

Phase alignment and limiter settings

Under limiter page set correct phase order to align phases on each device. Set correct main fuse limit [A] to protect the main grid fuse from over current. Check devices that can be managed by limiter and set correct limiter priority. Choose from no limiter, limit last, limit second, limit first. Max expected device current consumption is dynamically calculated and does not need to be set. In case device is a EV charging station, manually set max current for this device.

HEMS v1.2.0 wiring

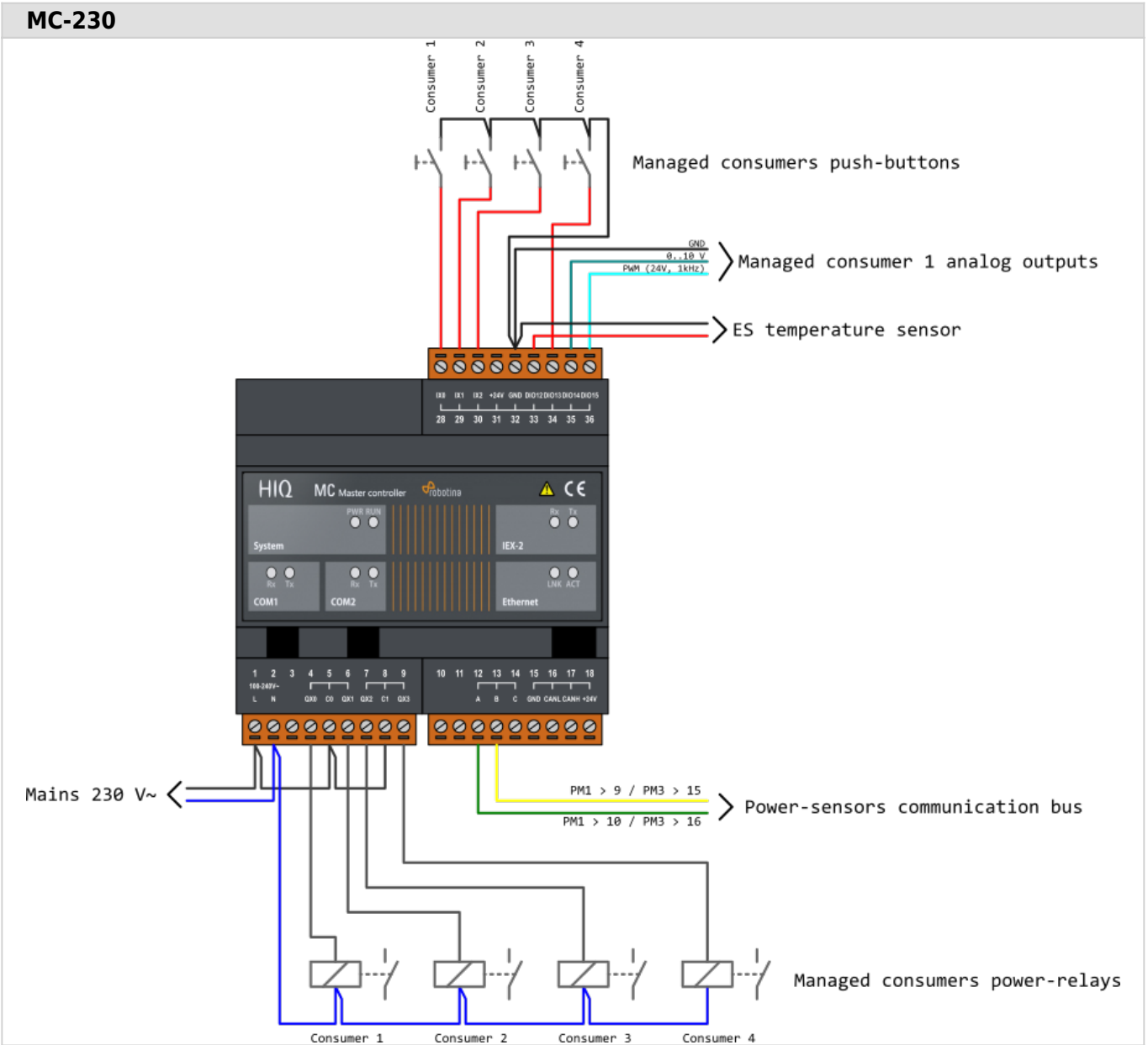

PM3-I-D

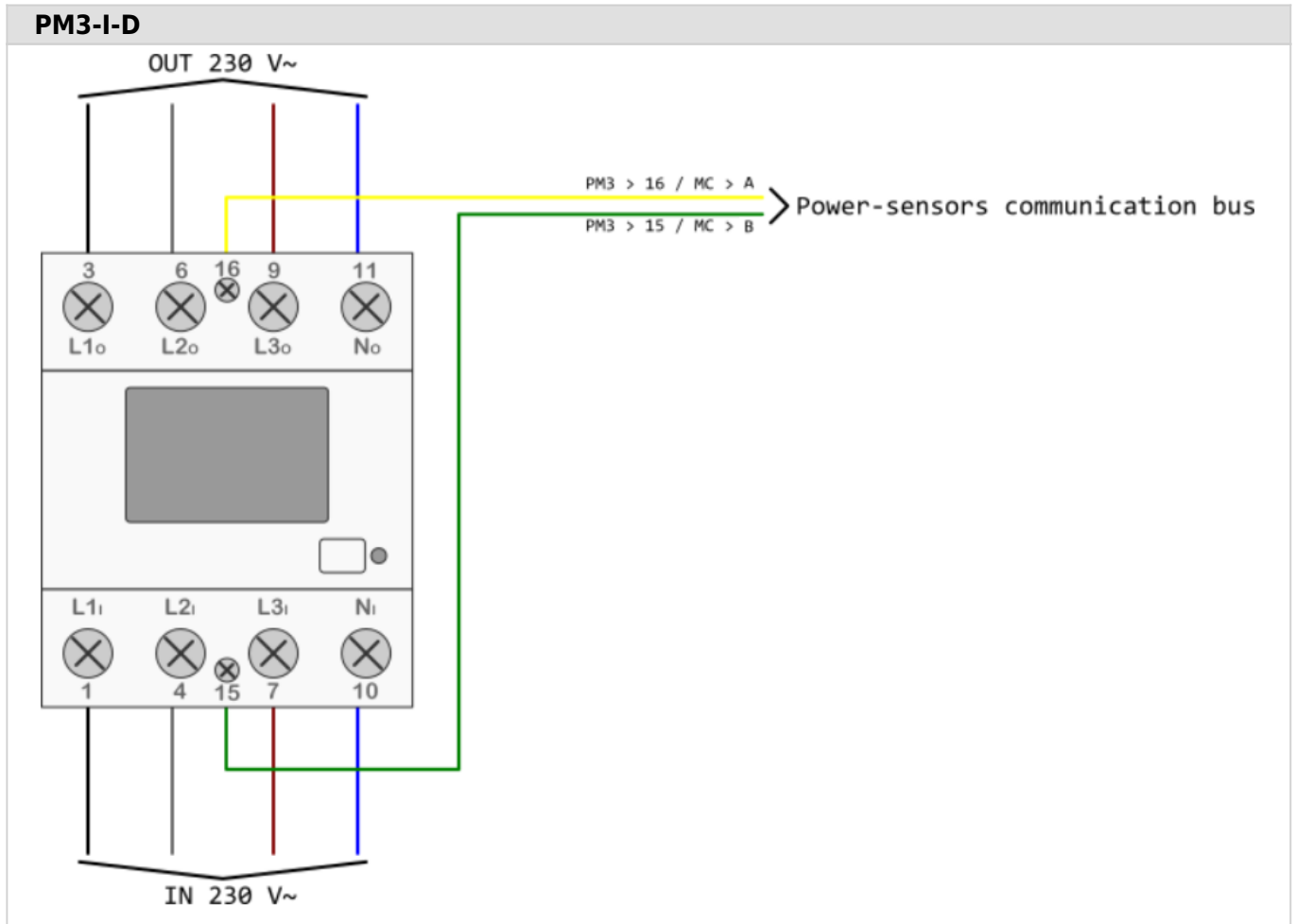

PM1-E-D

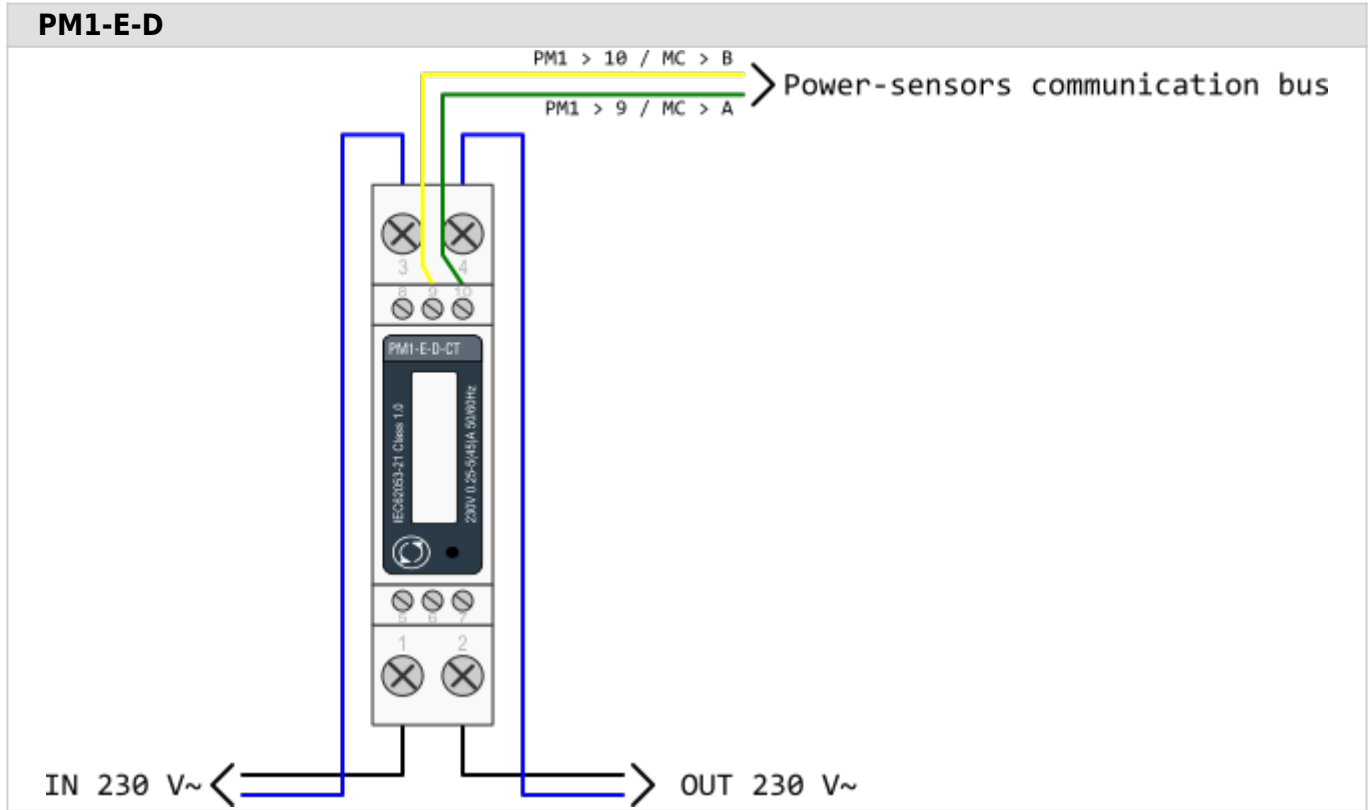

PM1-E-D-CT

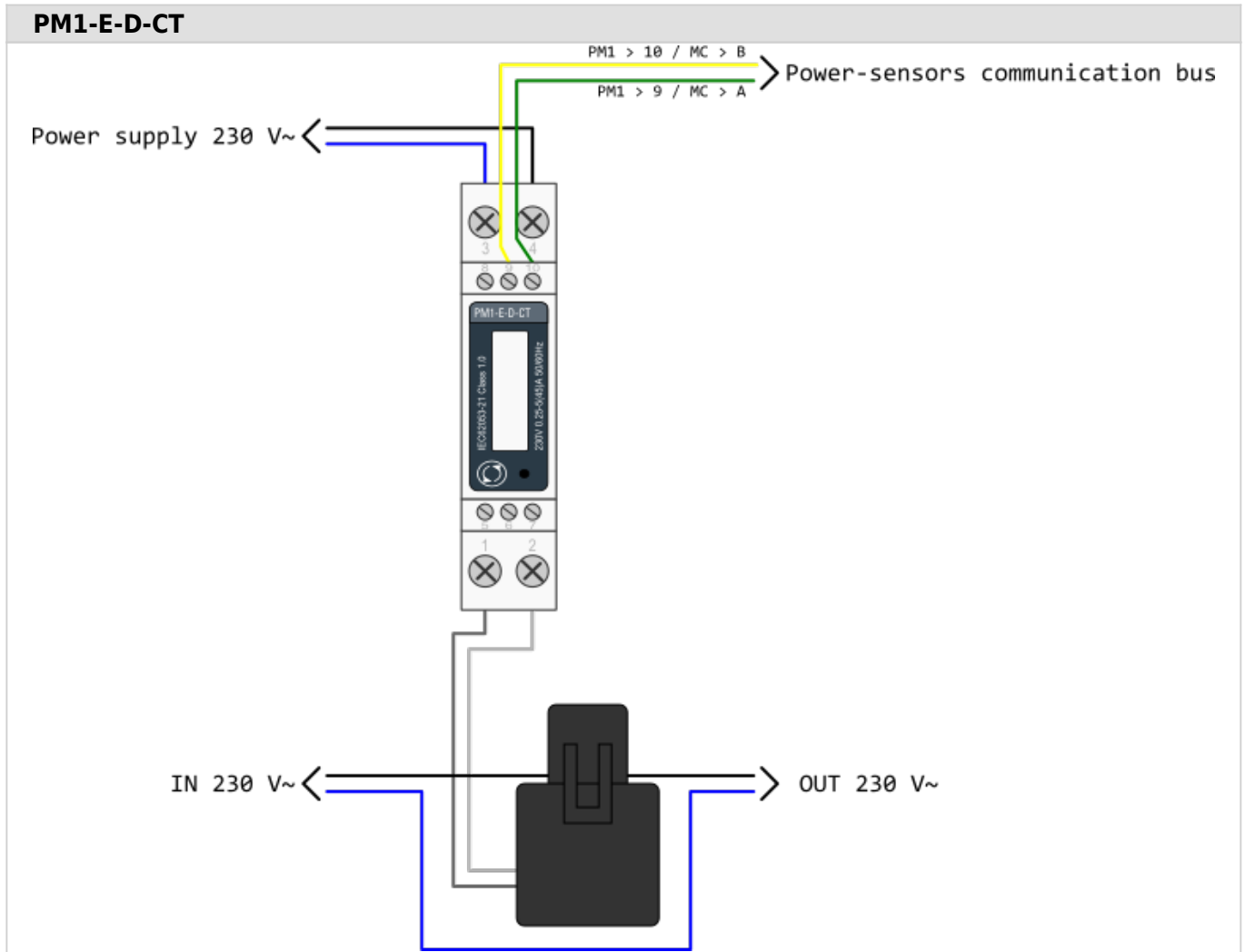

PM3-E-D-CT

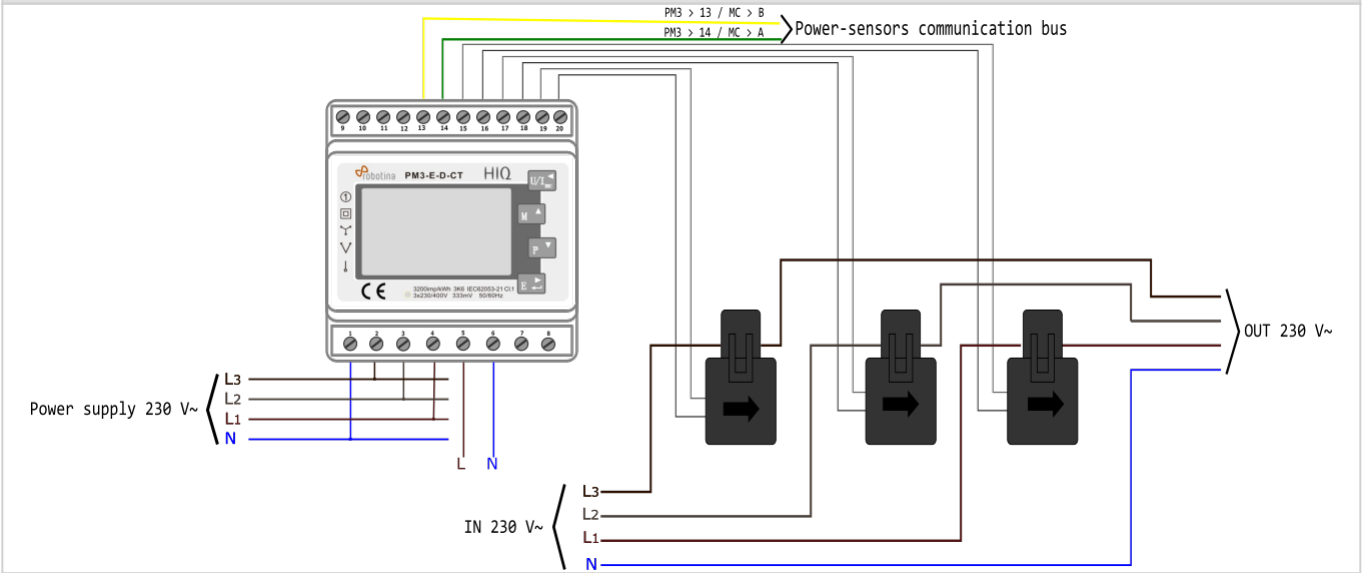

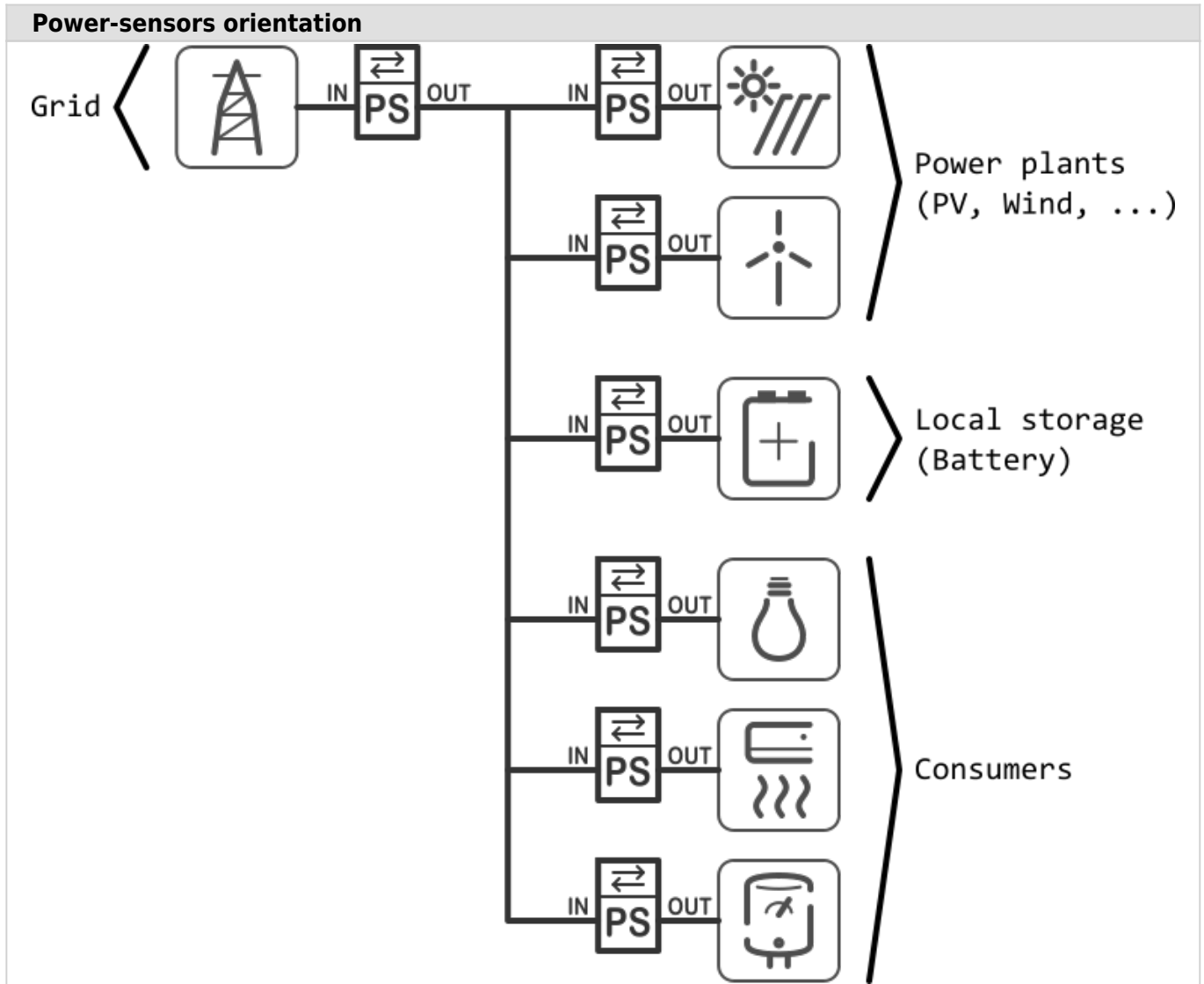

HEMS v1.2.0 Configurator

HEMS Configurator

home

Basic system overview.

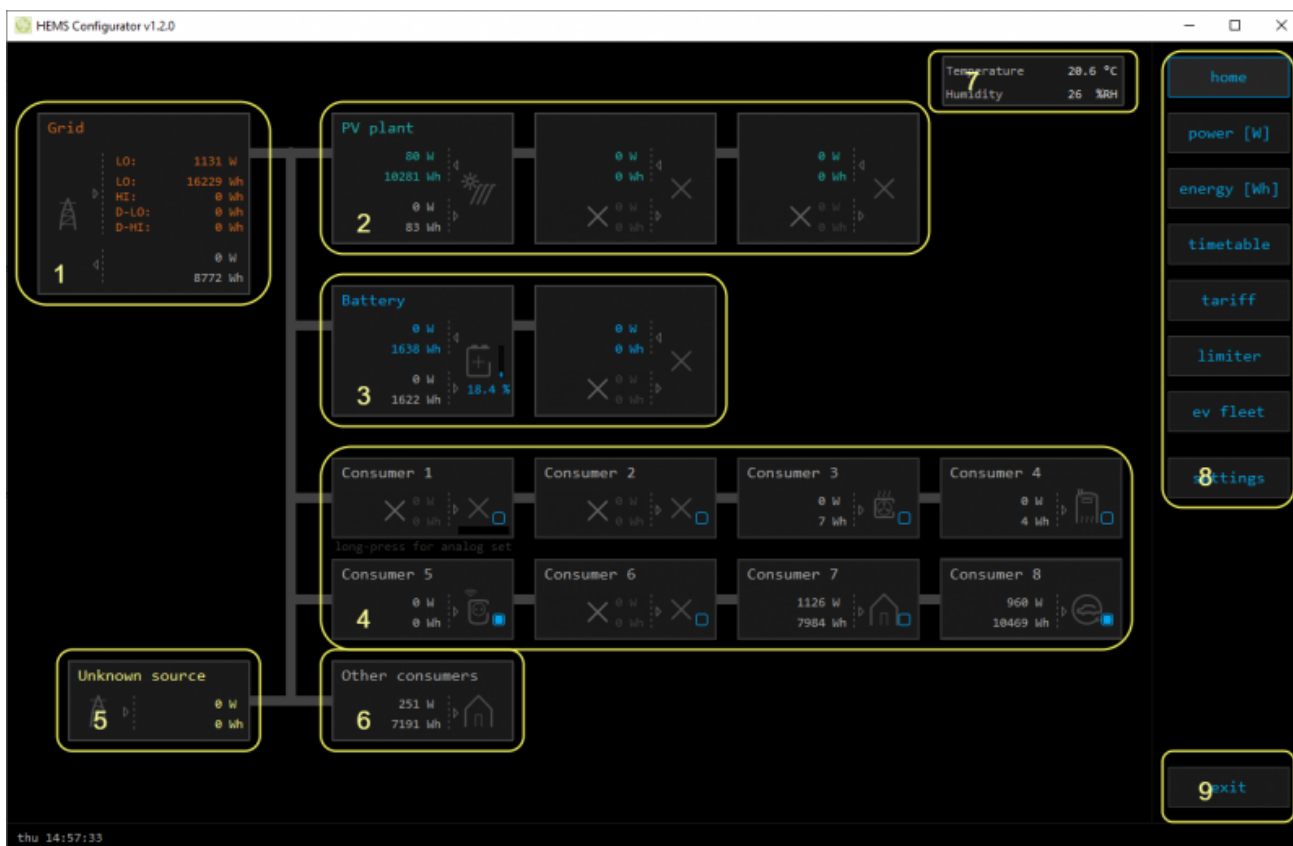

1. Grid		
>	From grid	Tariff (LO, HI, D-LO, D-HI) and power from grid in W Imported energy by tariff in Wh
<	To grid	Power exported to grid in W Exported energy in Wh
2. Plants		
<	Produced	Produced power in W and energy in Wh
>	Consumed	Consumed power in W and energy in Wh
3. Storage systems		
<	Sourced	Power in W and energy in Wh sourced from storage (battery)
>	Stored	Power in W and energy in Wh stored (to battery)
bargraph and %¹	SOC	Battery State Of Charge
4. Consumers		
>	Consumed	Consumed power in W and energy in Wh

[]	Status	Output status for managed consumers
bargraph ²	Analog out	Analog output value
click	Toggle	Click in frame toggles managed consumers output
long-press ²	Set analog	Long press on first consumer pops-up dialog for analog value set
5. Unknown source		
>	Sourced	Power in W and energy in Wh from unknown source
! Accumulate also all differences caused by power-sensor inaccuracy		
6. Other consumers		
>	Consumed	Consumed power in W and energy in Wh by other (not measured) consumers
7. Temperature and humidity		
	Temperature	Temperature in °C
	Humidity	Humidity in % RH
8. Page navigation		
	Home	Home screen
	Power [W]	Power screen
	Energy [Wh]	Energy screen
	Timetable	Timetable screen
	Tariff	Tariff screen
	Limiter	Limiterscreen
	EV fleet	EV fleet screen
	Settings	Settings screen
9. Exit		
	Exit	Close application

¹ only for eStore

² only for first managed consumer

power

Overview of current power distribution by source / consumer.

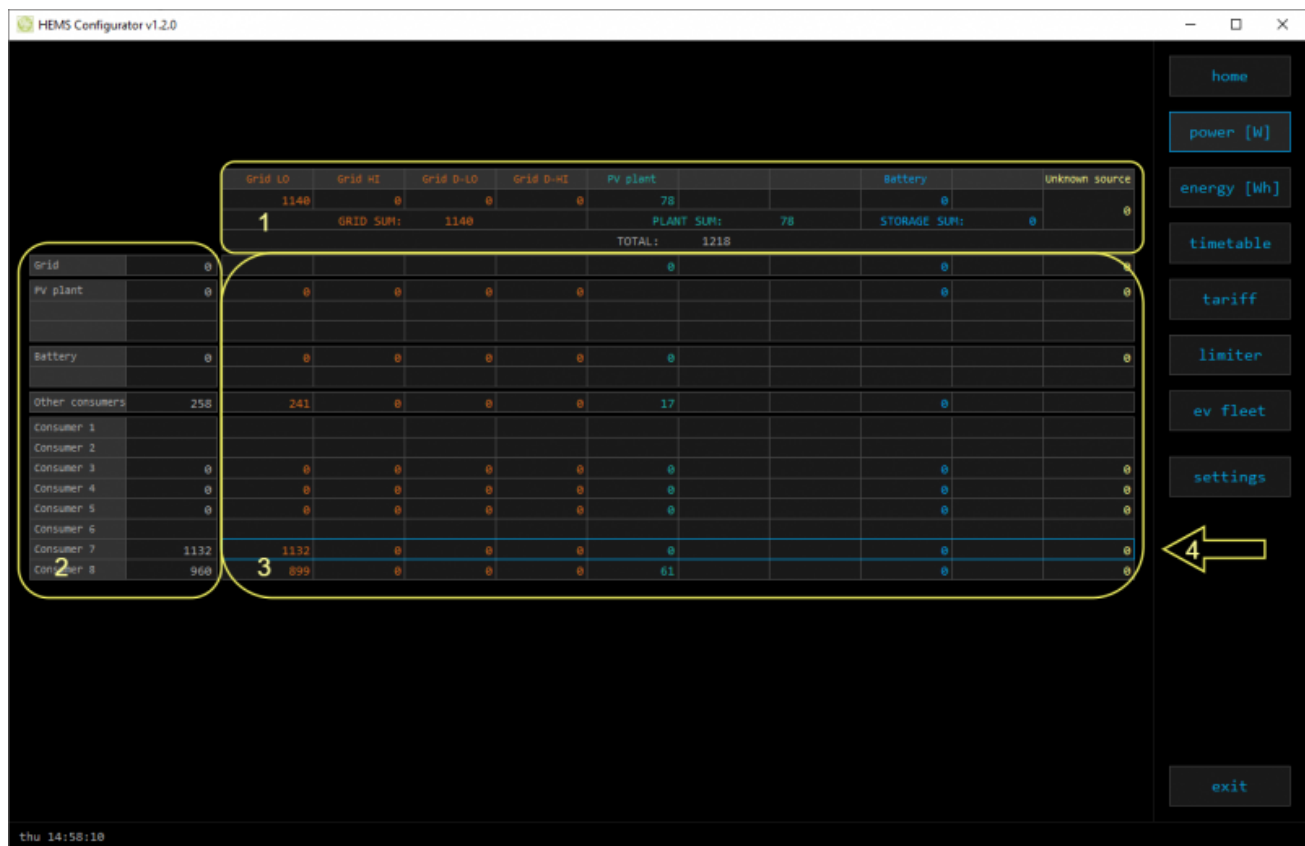

1. Sourced power

Sourced power for each source

Sums per source type

Total of all sourced power

2. Consumed power

Power for each consumer

3. Power distribution

Partial distributed power

4. Submeter (Blue outline)

Power meter is not part of internal circuit

HEMS Configurator v1.2.0

	Grid LO	Grid HI	Grid D-LO	Grid D-HI	PV plant	Battery	Unknown source
	1140	0	0	0	78	0	0
	GRID SUP: 1140				PLANT SUP: 78	STORAGE SUP: 0	0
					TOTAL: 1318		
2	0				0	0	0
PV plant	0	0	0	0	0	0	0
Battery	0	0	0	0	0	0	0
Other consumers	258	241	0	0	17	0	0
Consumer 1							
Consumer 2							
Consumer 3	0	0	0	0	0	0	0
Consumer 4	0	0	0	0	0	0	0
Consumer 5	0	0	0	0	0	0	0
Consumer 6							
Consumer 7	1132	1132	0	0	0	0	0
Consumer 8	960	899	0	0	61	0	0

Navigation buttons: home, power [W], energy [Wh], timetable, tariff, limiter, ev fleet, settings, exit

thu 14:58:10

1. Sourced power distribution

How sourced power is consumed by each consumer

2. Consumed power distribution

Who sources consumed power

energy

Energy overview of a given time distributed by sources / consumers.

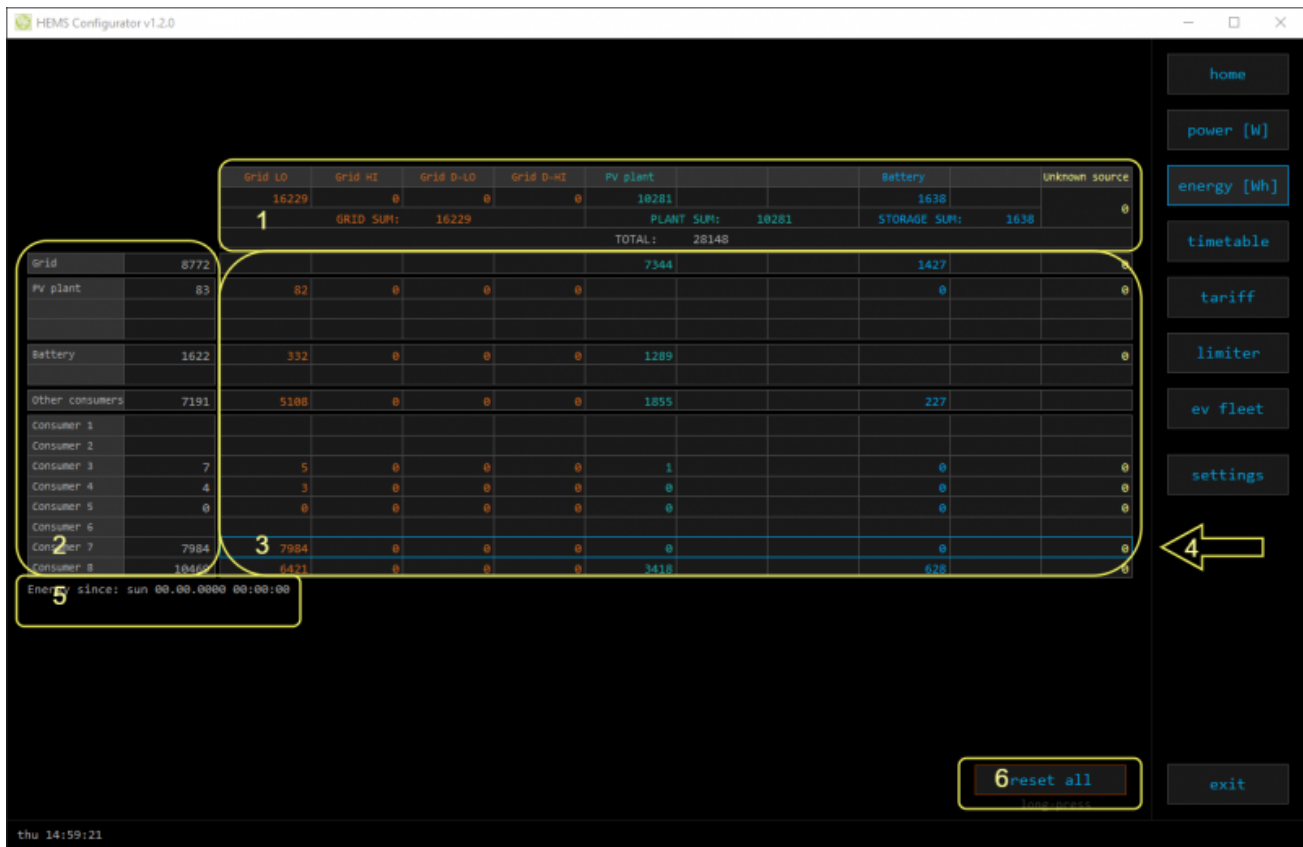

1. Sourced energy

Sourced energy for each source

Sums per source type

Total of all sourced energy

2. Consumed energy

Energy for each consumer

3. Energy distribution

Partial distributed energy

4. Submeter (Blue outline)

Power meter is not part of internal circuit

5. Energy since

Date and time since energy is recorded

6. Reset all

Long-press to reset all energy counters

timetable

Weekly timetable for managed consumers.

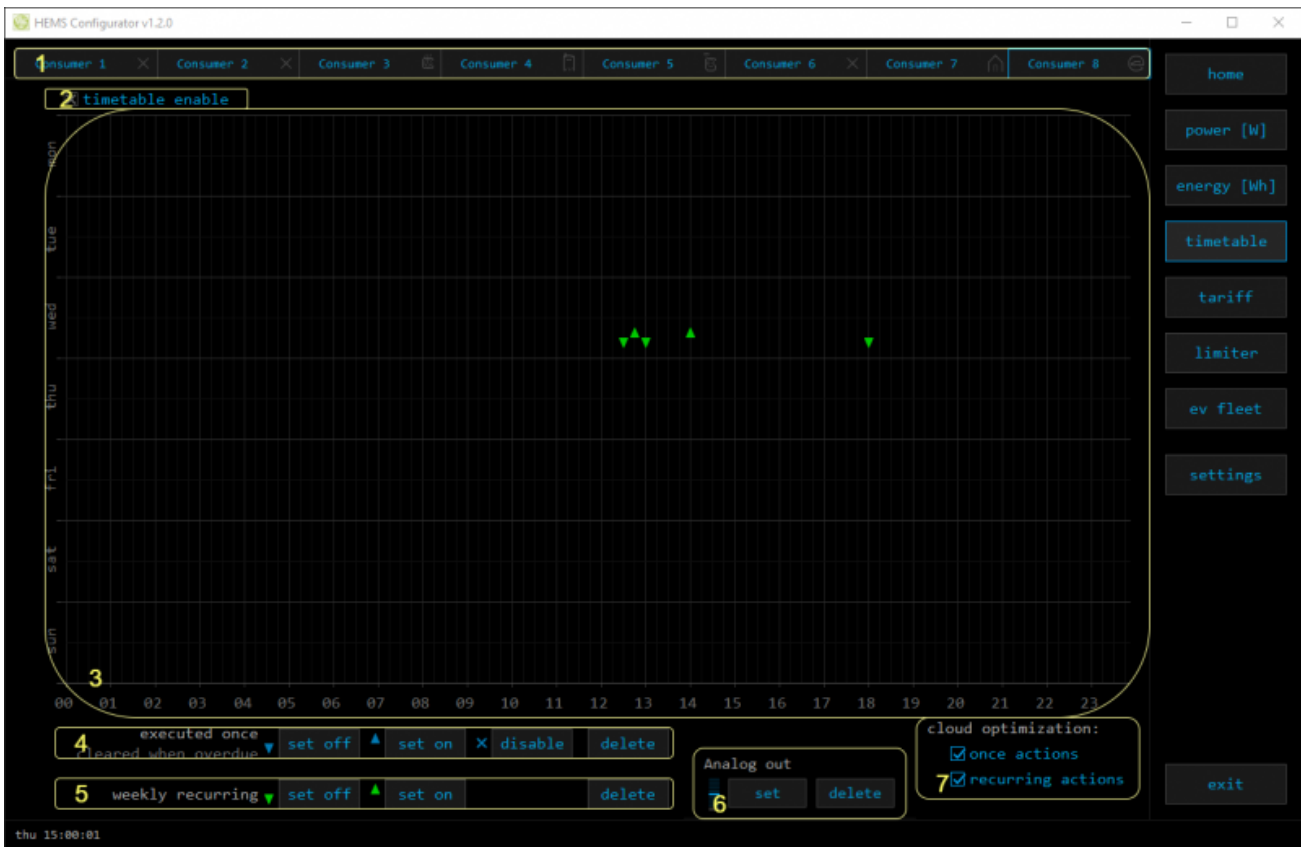

1. Managed load menu

Switch between managed loads

2. Enable checkbox

When un-checked timetable is not executed

3. Events grid

Events displayed in weekly grid (15 min resolution)

Click to select time and set event by clicking buttons below

4. Once actions (top priority timetable actions)

Actions are executed and then automatically cleared.

“Disable” action will just disable recurring action.

5. Recurring actions (low priority actions)

Actions are executed each week.

6. Analog out ¹

Action to set analog output. Analog actions are recurring.

7. Cloud optimization

When enabled (checked) cloud optimization is enabled.

¹ only for Consumer 1

tariff

Weekly tariff timetable for grid energy per tariff distribution.

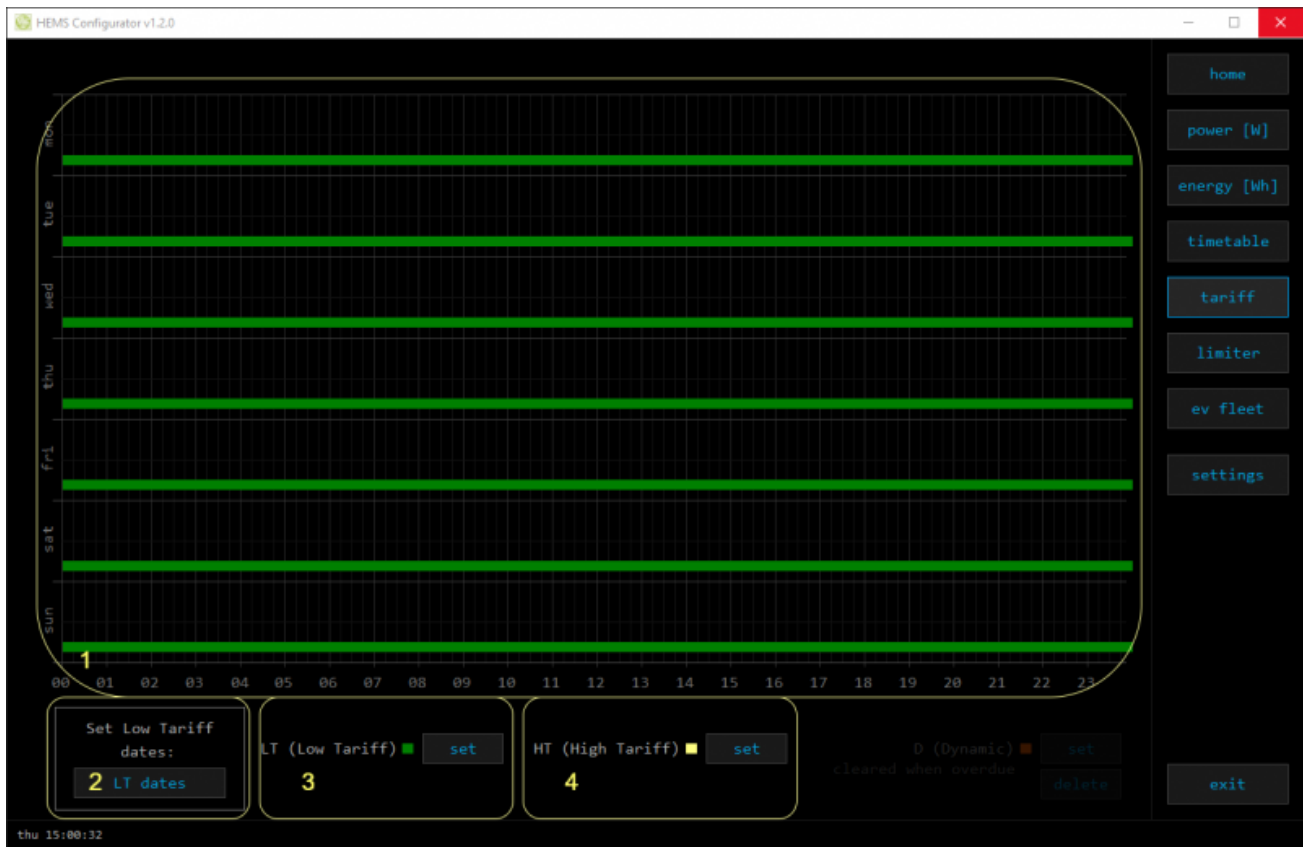

1. Tariff grid

Graphical weekly timetable with tariffs.

Click to select term, click-and-drag to select multiple terms.

2. Low tariff dates

Set low tariff dates for holidays.

3. Low tariff

Set low tariff for selected terms.

4. High tariff

Set high tariff for selected terms.

lo tariff dates

Holiday dates when tariff is low

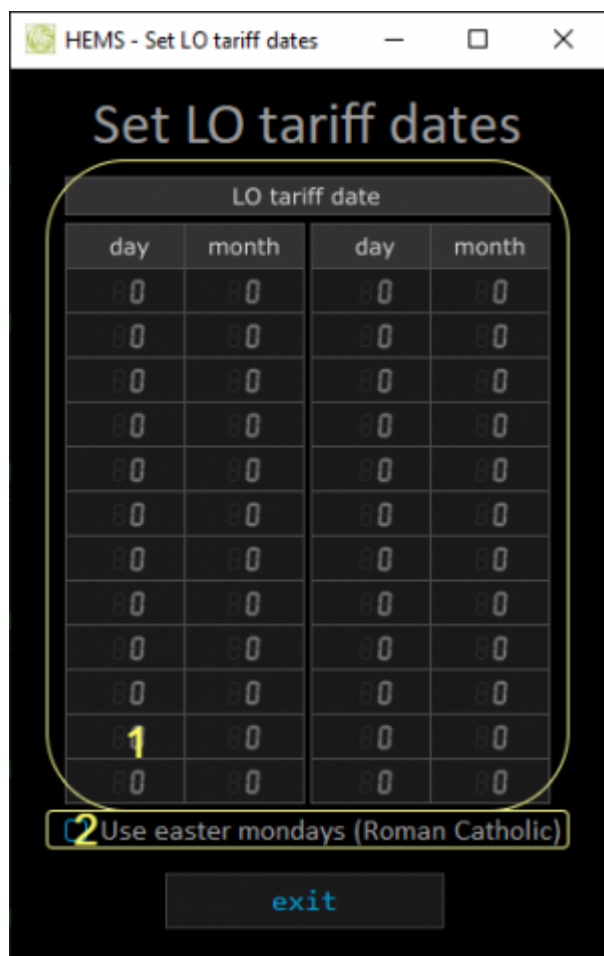

1. Date table

Up to 24 days when tariff is low on holiday

2. Use easter mondays

Use preprogrammed roman-catholic easter monday holidays

limiter

Overview and configuration of limiter

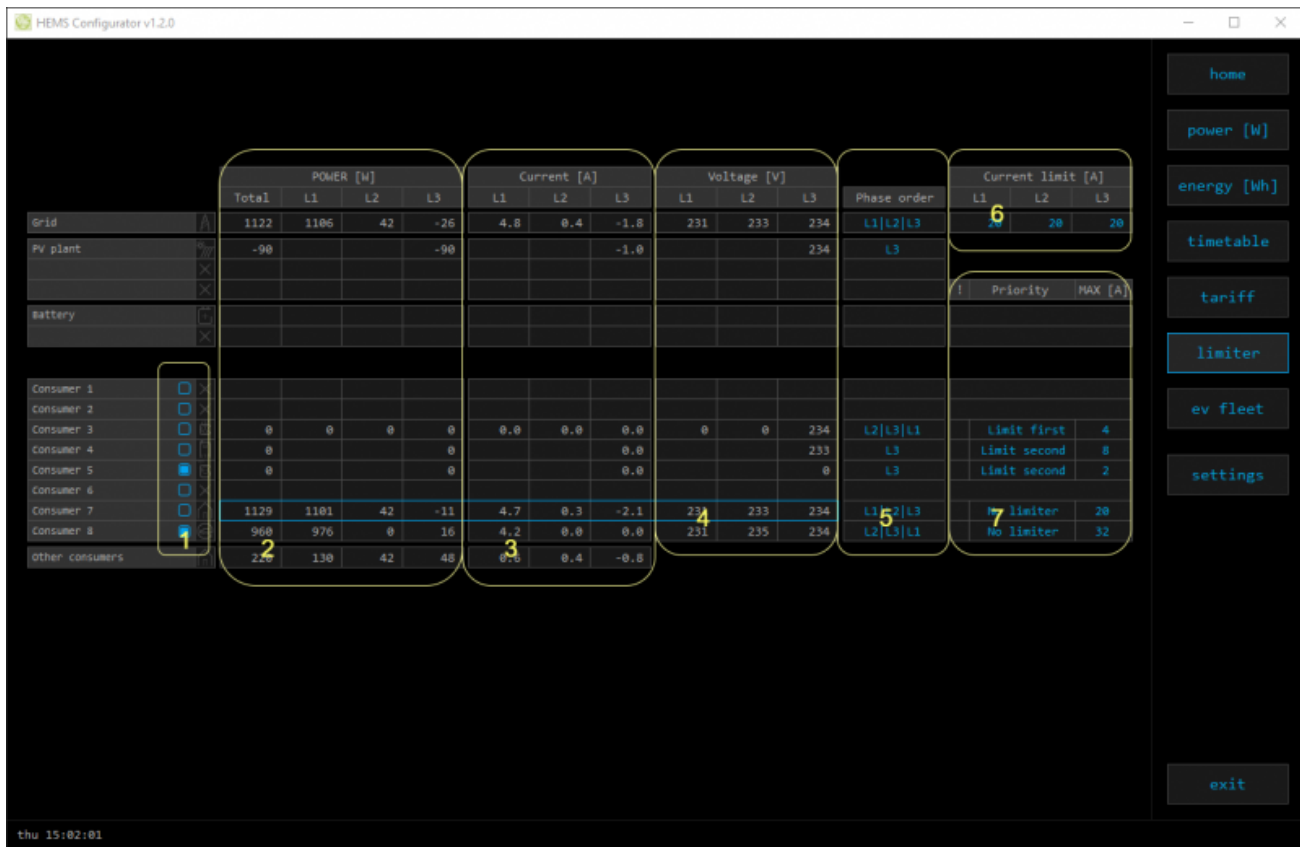

1. Consumer management	
Turn consumers on or off	
2. Power	
Total power and power for each phase	
3. Current	
Current for each phase	
4. Voltage	
Voltage for each phase	
5. Phase order	
Setting correct phase order after power meters were installed (commissioning)	
6. Current limit	
Current limit threshold for main grid fuse	
7. Status, priority and current setpoint	
! ⚠️	Status when limiter is active
Priority	Device priority group (no limiter, limit last, limit second, limit first)
Max [A] ¹	Device expected current draw

¹ parameter is dynamically set for all devices, except for the EV charging stations

ev fleet

Overview and configuration of EV charging stations

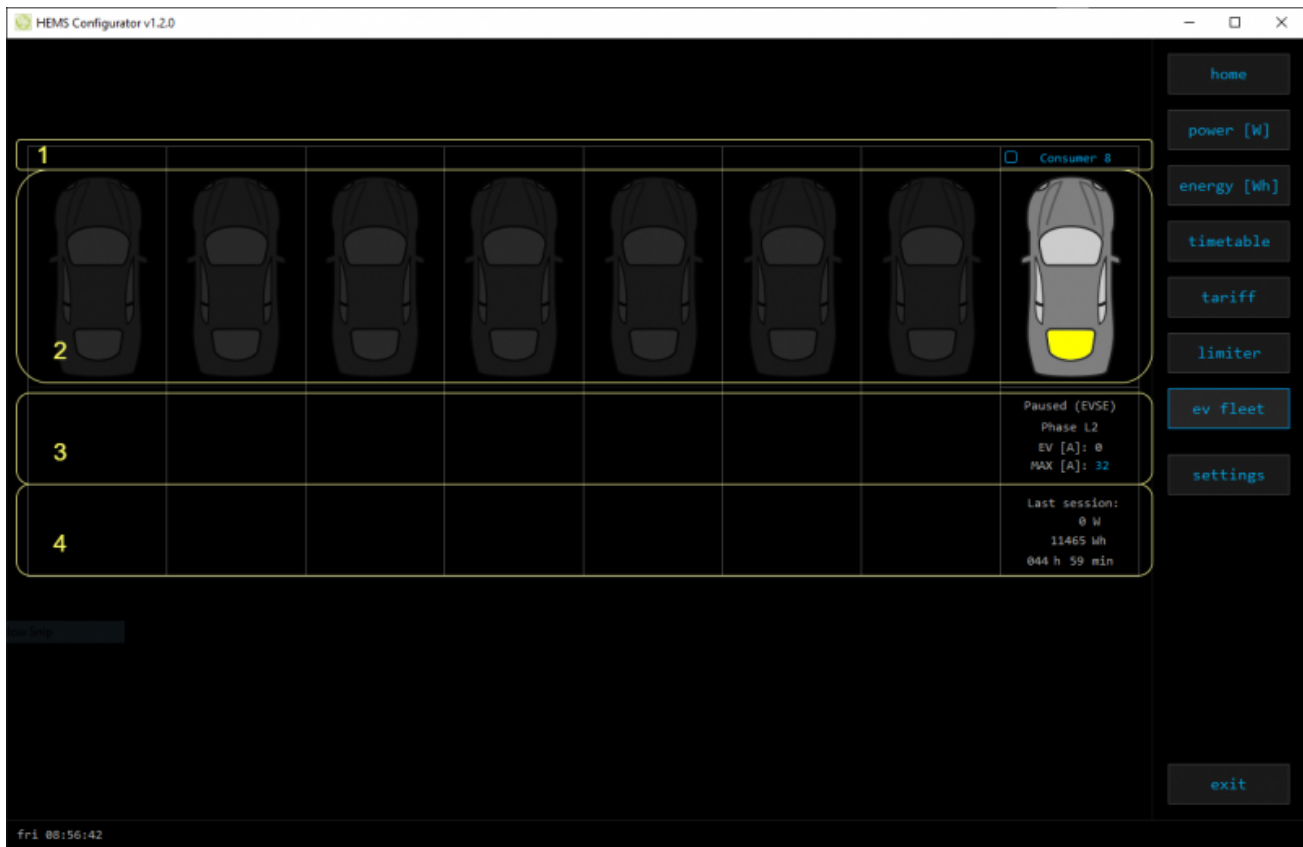

1. EV charging station management

Turn EV station on or off

2. EV vehicle status

GREY	Stand by
RED	Error
YELLOW	Charging paused
BLUE	Charging
GREEN	Charging done

3. EV charging station status

Status	Status of EV charging station
Phase detection	Detection of utilized phases
EV [A]	EV charger max allowed current
MAX [A]	User set MAX charging current

3. EV charging session

Power	Actual power draw
Energy	Energy delivered to EV
Duration	Session charging duration

settings

Easy and intuitive system setup.



1. System settings		
	[autodetect]	Click to find HEMS in local network
eStore	c.....	eStore serial number (automatically detected or can be entered manually).
	[] enable	When checked HEMS will read Grid, first plant and first Storage directly from eStore (so there is no need to duplicate power-sensor).
	[detect]	eStore address is cleared and new eStore can be detected.
HIQ Home	c.....	HIQ Home serial number (automatically detected or can be entered manually).
	[] enable	When checked HEMS will read Grid power and energy from HIQ Home (so there is no need to duplicate power-sensor).
	[detect]	HIQ Home address is cleared so new can be detected.
Virtual grid PM	[] enable	Check if system is without main grid power meter. Energy, power and currents are calculated from other power meters.
2. Internet access and modbus		

[] enable	When checked HEMS is automatically connected to HIQ Universe cloud service. The connection is initialized by the HEMS system and uses UDP packets on port 8442.	
[test]	New "push" message is sent to server and roundtrip time is rechecked.	
[reset]	Clear messages counts and roundtrip time	
push timer	Timer in s for send "push" message to server	
messages	Sent "push" messages / responses counters	
roundtrip	Time in ms between sent push message and response.	
Modbus cycle time	Time in ms for modbus communication to complete reading of all connected devices.	
3. Sources and Consumers settings table		
SOURCES	Source name	
icon	Source icon	
4. Device status		
Status	Status OK, Warning, Error, Detected	
5. Device message		
source and consumer management	Source or consumer power-sensor management	
	message	Messages regarding source or consumer power-sensor
6. Device configuration		
Configuration	add	Associate new power-sensor to source or consumer
	del	Disassociate power-sensor from source or consumer & configure it as new power-sensor
7. Device type		
meter	Source or consumer power-sensor type	
configuration	in/ex	Power plant connection ¹
8. Submeter option		
sub	Check if this power meter or device is not part of internal circuit. Energy division for this device is ignored and outlined in blue border.	
9. Wireless settigs		
new device	Power-sensor configured as new one detected or wireless module configuration ²	
Wireless setting	Setting up wireless modules: pairing, adding and delete the wireless modules and setting repeater level	
10. Device output		
output	Consumer output type	
	<<>>	Set repeater level ³
man. time	Manged consumer manual override timer	
out mode	Manged consumer output mode (normal or inverted)	
timetable	Manged consumer timetable execution enabled	
11. Permanent memory parameters		
[init parameters]	Init all parameters to default values	
[save parameters]	Save all parameters to permanent memory	
[read parameters]	Read all parameters from permanent memory	

[] autosave parameters	Parameters will be automatically saved to permanent memory in 15 minutes after last parameter change
12. Backup / Restore to PC	
[backup]	Backup all parameters to PC
[restore]	Restore all parameters from PC backup

¹ only for the first power plant

² wireless setting must be enabled

³ only for wireless modules and wireless setting must be enabled

HIQ UNIVERSE

HIQ Universe is a cloud service that enables:

- An overview of current power consumption
- An overview of the history of electrical power and energy consumption and production
- An overview and control of connected devices

Access point: <https://my.hiq-universe.com>

HIQ Universe Log-in

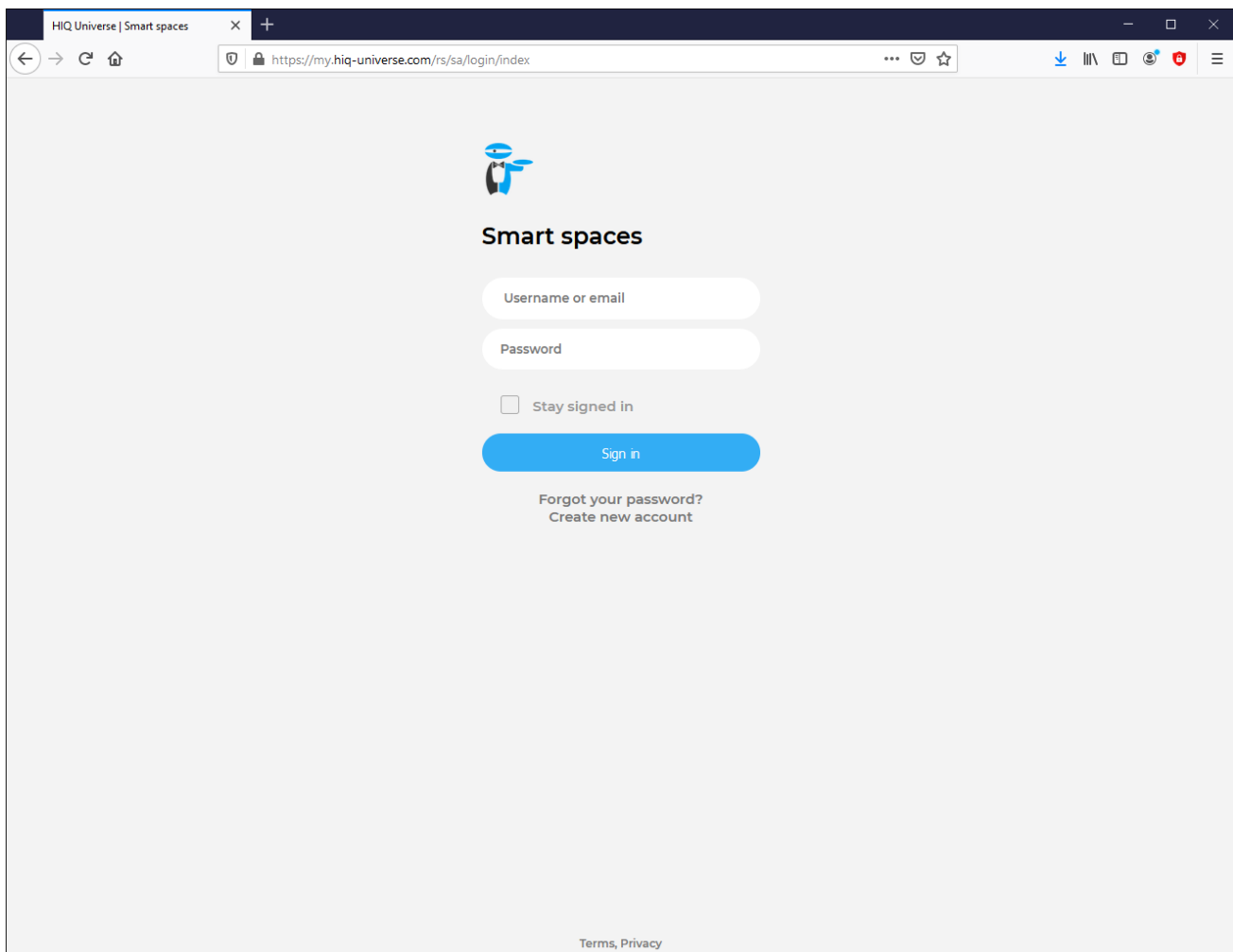

HIQ Universe | Smart spaces

https://my.hiq-universe.com/rs/sa/login/index



Smart spaces

Username or email

Password

Stay signed in

Sign in

[Forgot your password?](#)
[Create new account](#)

[Terms, Privacy](#)

Log in with your username or email and password to see your [HIQ Universe subscription dashboard](#).

To reset forgotten password click on "[Forgot your password?](#)"

To create new account click on "[Create new account](#)".

Create HIQ Universe account

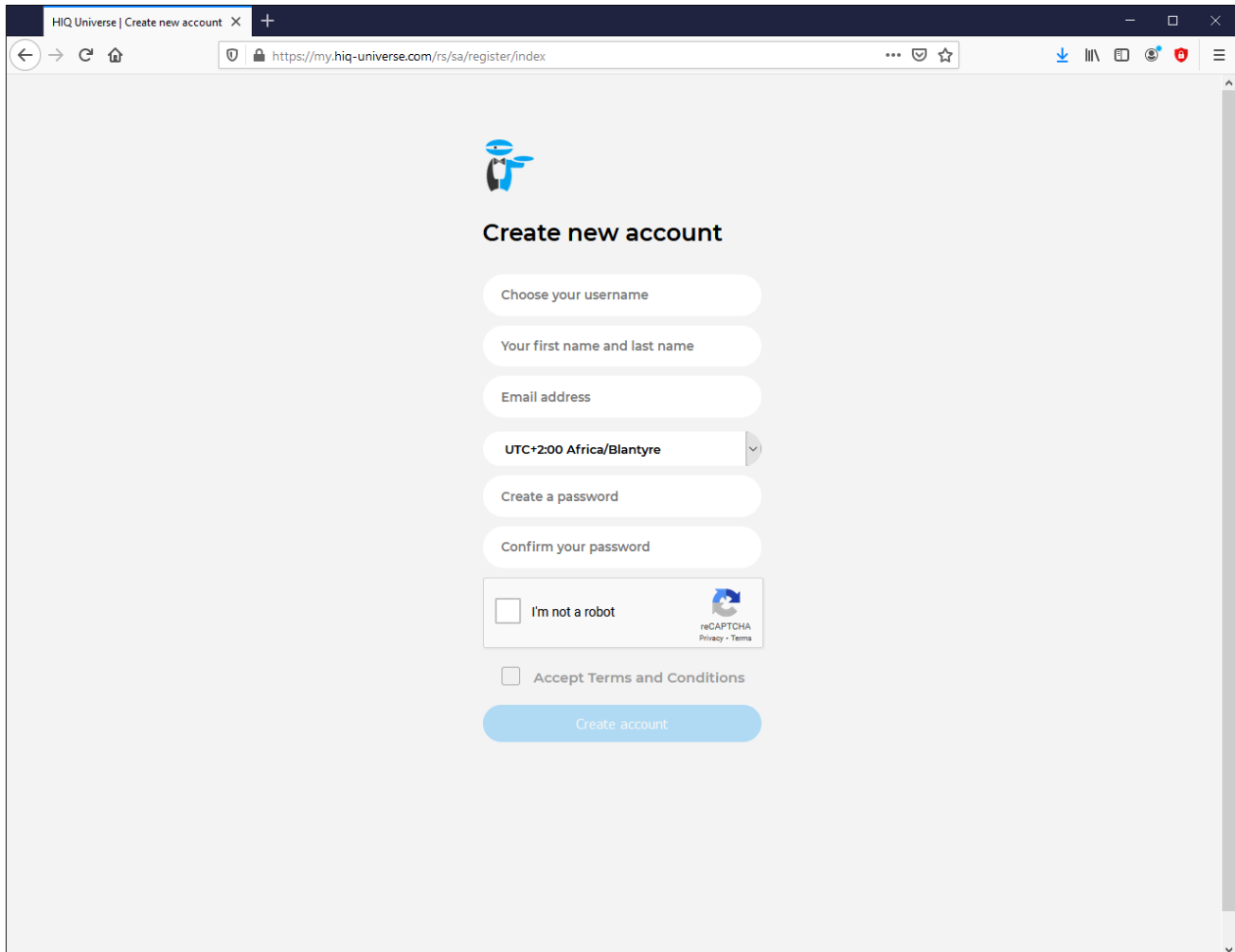

HIQ Universe | Create new account

Choose your username

Your first name and last name

Email address

UTC+2:00 Africa/Blantyre

Create a password

Confirm your password

I'm not a robot

Accept Terms and Conditions

Create account

In the appropriate fields, enter:

- Username
- First and Last name
- E-mail address
- Timezone
- Password

Click on "I'm not a robot"

Accept Terms and Conditions.

Click on Create account.

A confirmation link will be sent to your email address.

Proceed to ["HIQ Universe Log-in"](#) screen.

Reset forgotten password

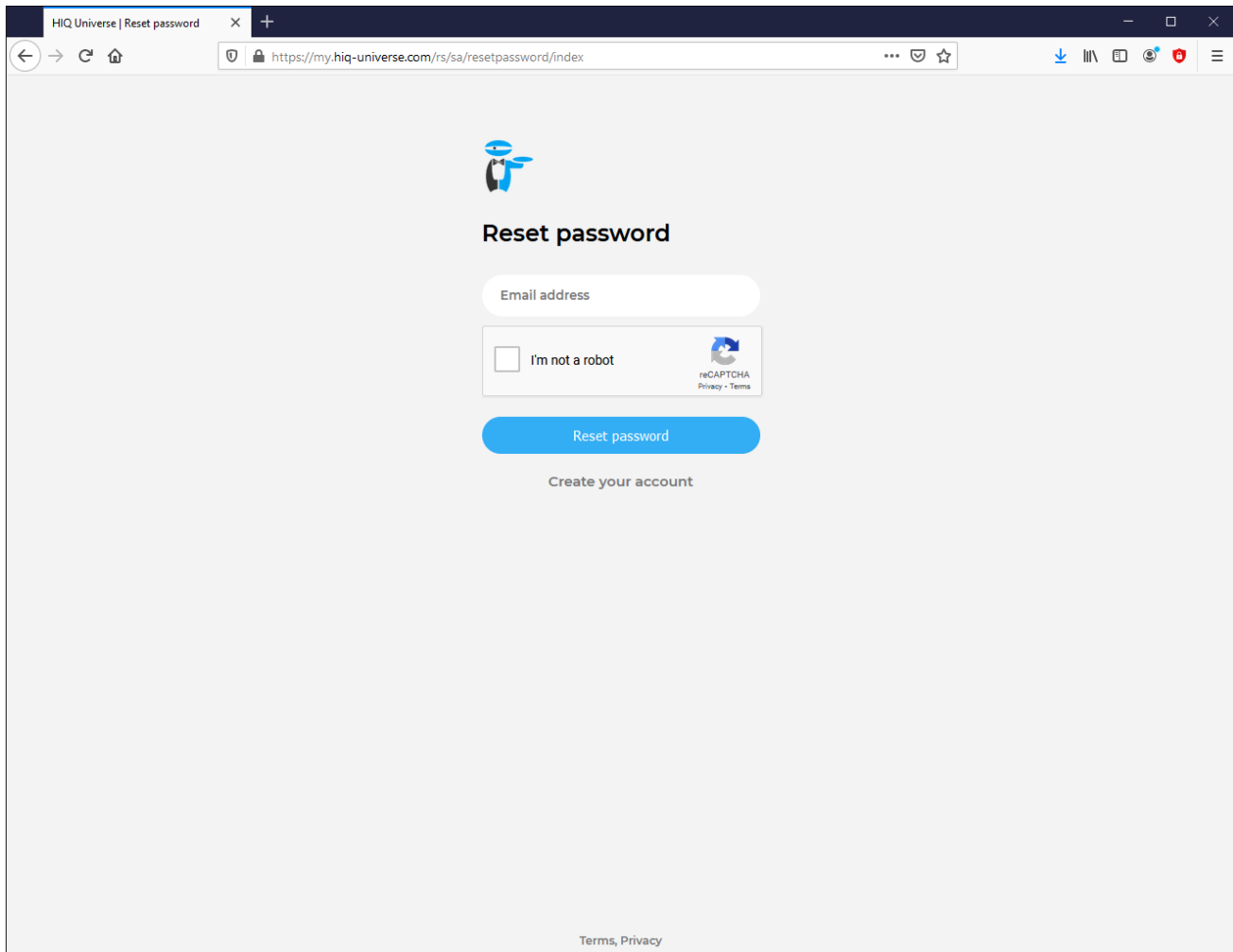

The screenshot shows a web browser window with the address bar displaying "https://my.hiq-universe.com/rs/sa/resetpassword/index". The page title is "HIQ Universe | Reset password". The main content area features a blue robot icon at the top, followed by the heading "Reset password". Below the heading is a white input field labeled "Email address". Underneath the input field is a reCAPTCHA widget with the text "I'm not a robot" and a checkbox. To the right of the checkbox is the reCAPTCHA logo and the text "reCAPTCHA Privacy - Terms". Below the reCAPTCHA widget is a prominent blue button labeled "Reset password". At the bottom of the form area, there is a link that says "Create your account". At the very bottom of the page, there is a small link for "Terms, Privacy".

In the appropriate field, enter email address.

Click on "I'm not a robot"

Click on "Reset password".

You will receive email with password reset link.

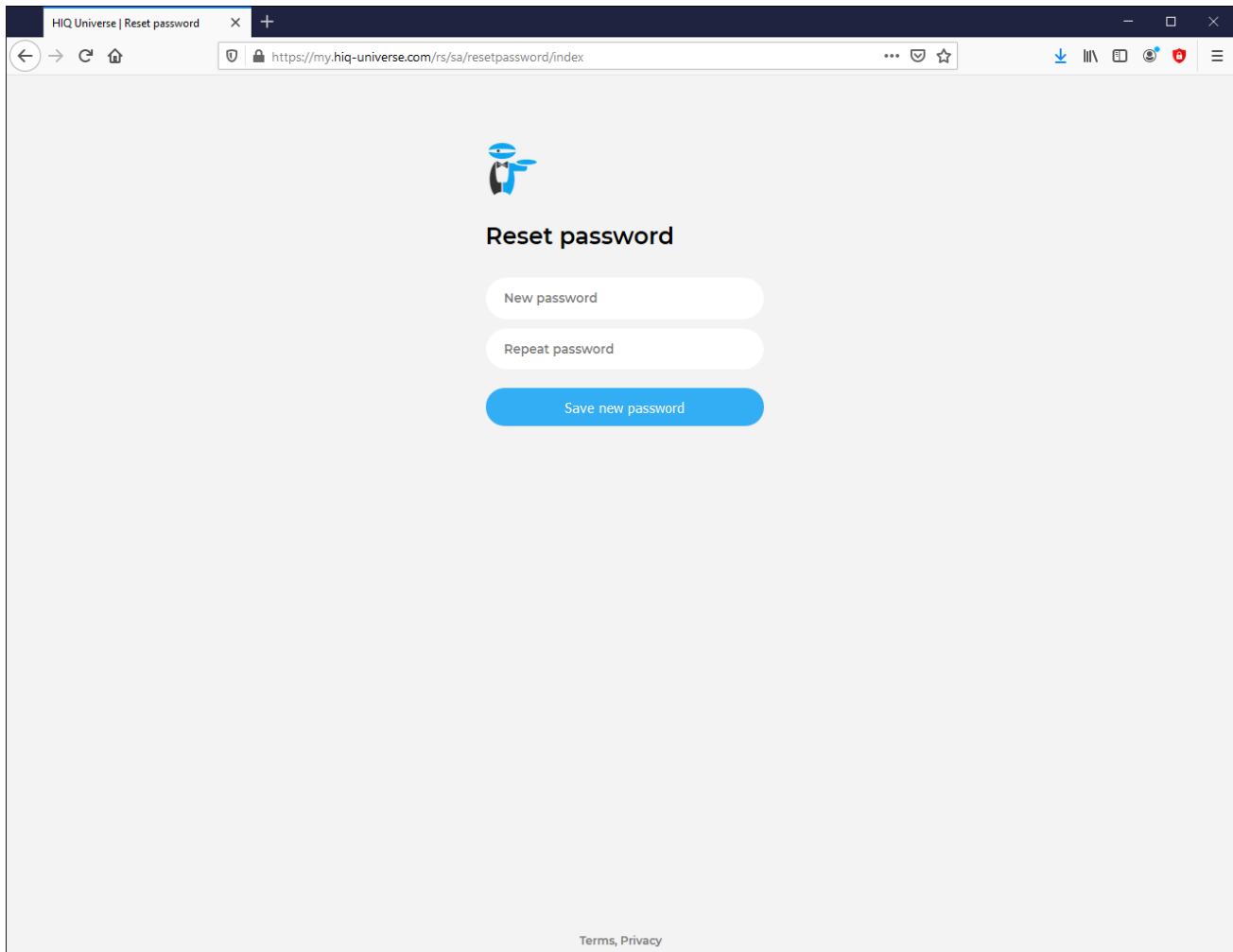

The screenshot shows a web browser window with the title "HIQ Universe | Reset password". The address bar displays the URL "https://my.hiq-universe.com/rs/sa/resetpassword/index". The page content features a blue robot icon at the top center, followed by the heading "Reset password". Below the heading are two input fields: "New password" and "Repeat password". A blue button labeled "Save new password" is positioned below the input fields. At the bottom center of the page, there is a link for "Terms, Privacy".

Enter new password and click on "Save new password".

Proceed to "[HIQ Universe Log-in](#)" screen.

Add HEMS controller

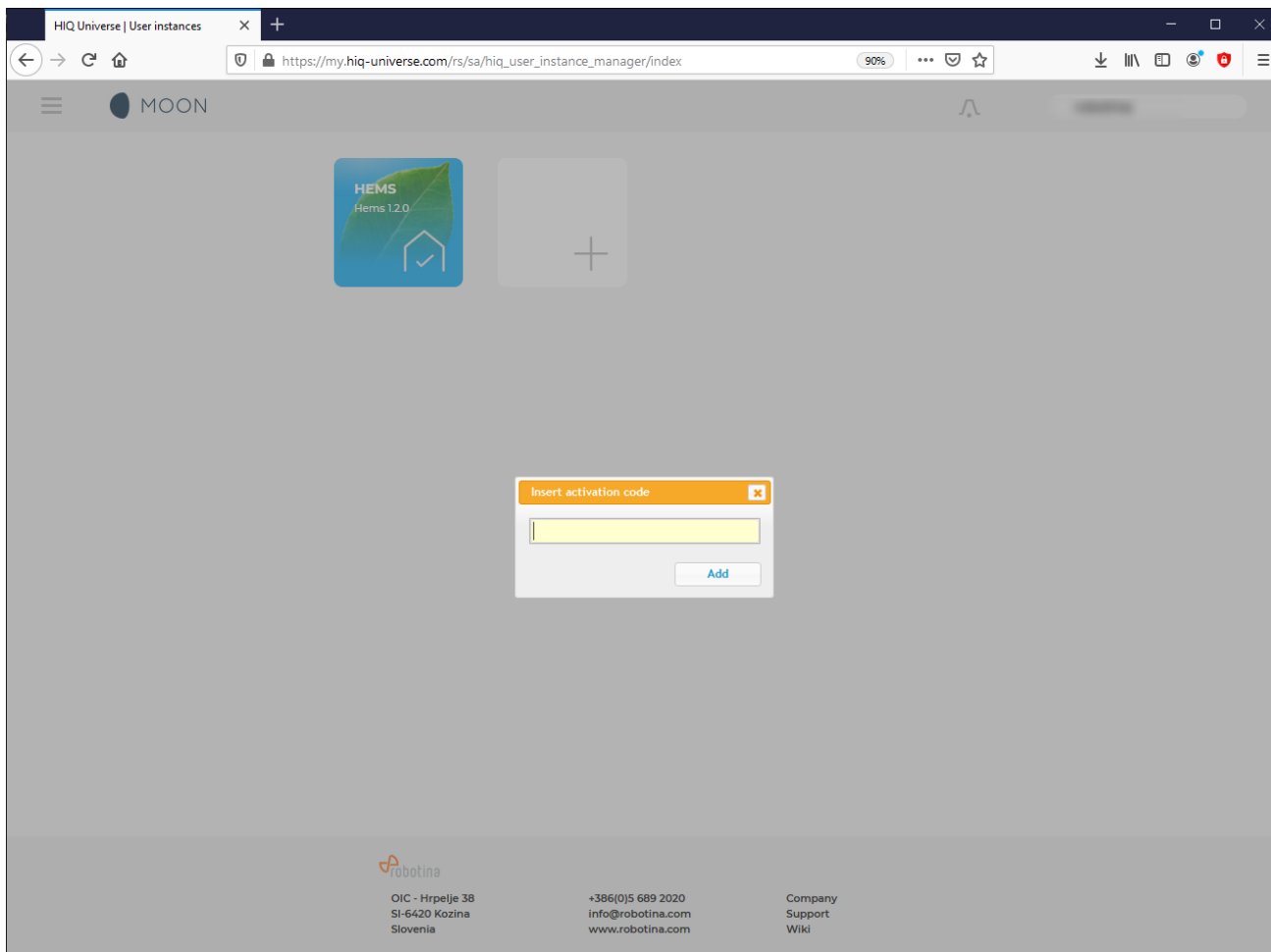

Enter HEMS activation code from “HEMS Quick Set-Up Guide” found in HEMS box.



HIQ Universe subscription dashboard

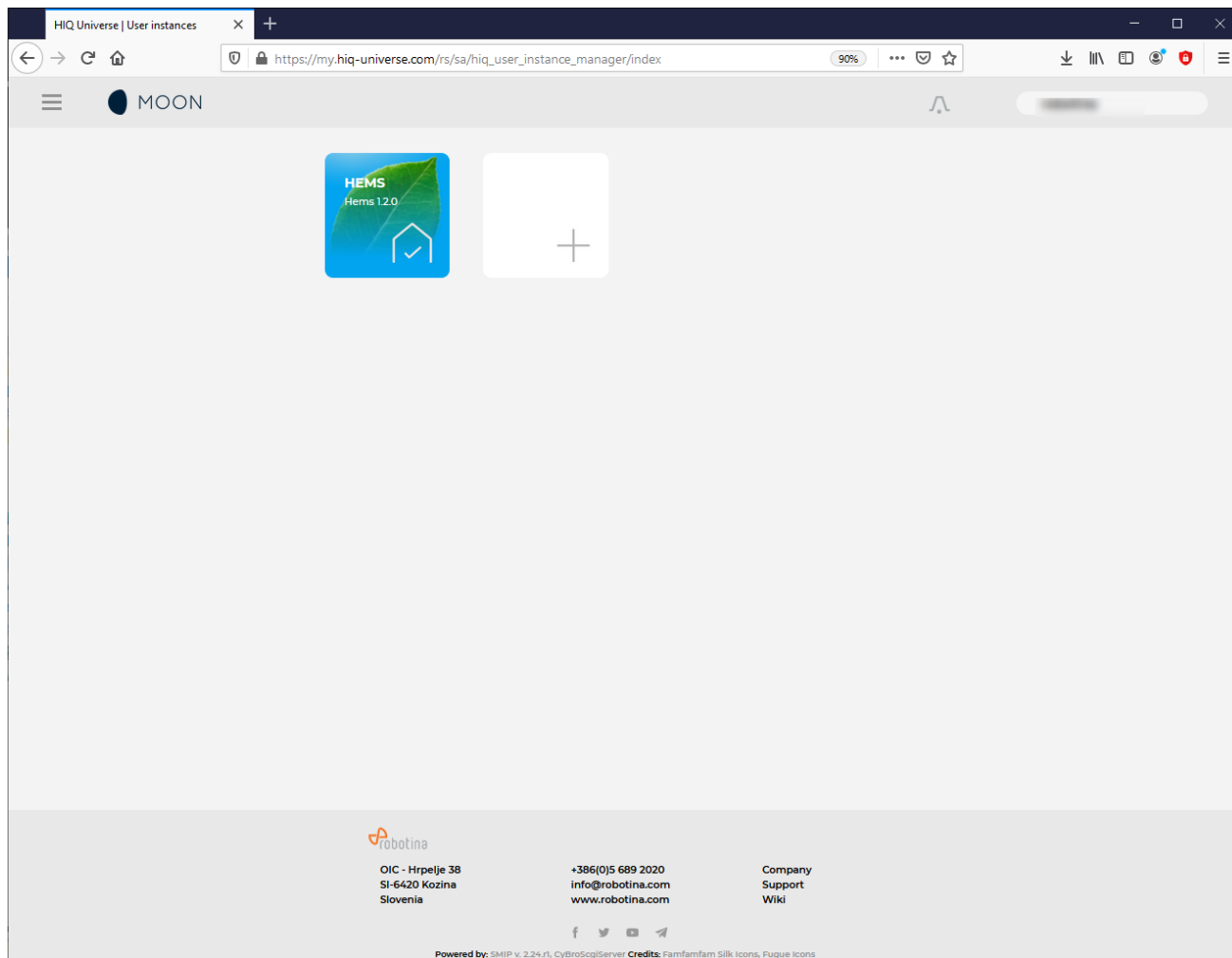

You will see tiles for all your subscribed HIQ Universe devices and services.

Go to [Main HEMS view](#) by clicking on HEMS tile or

add [new HEMS device](#) by clicking on blank tile with + sign.

["User profile set-up"](#) is invoked by clicking on user name on top right.

Main HEMS view

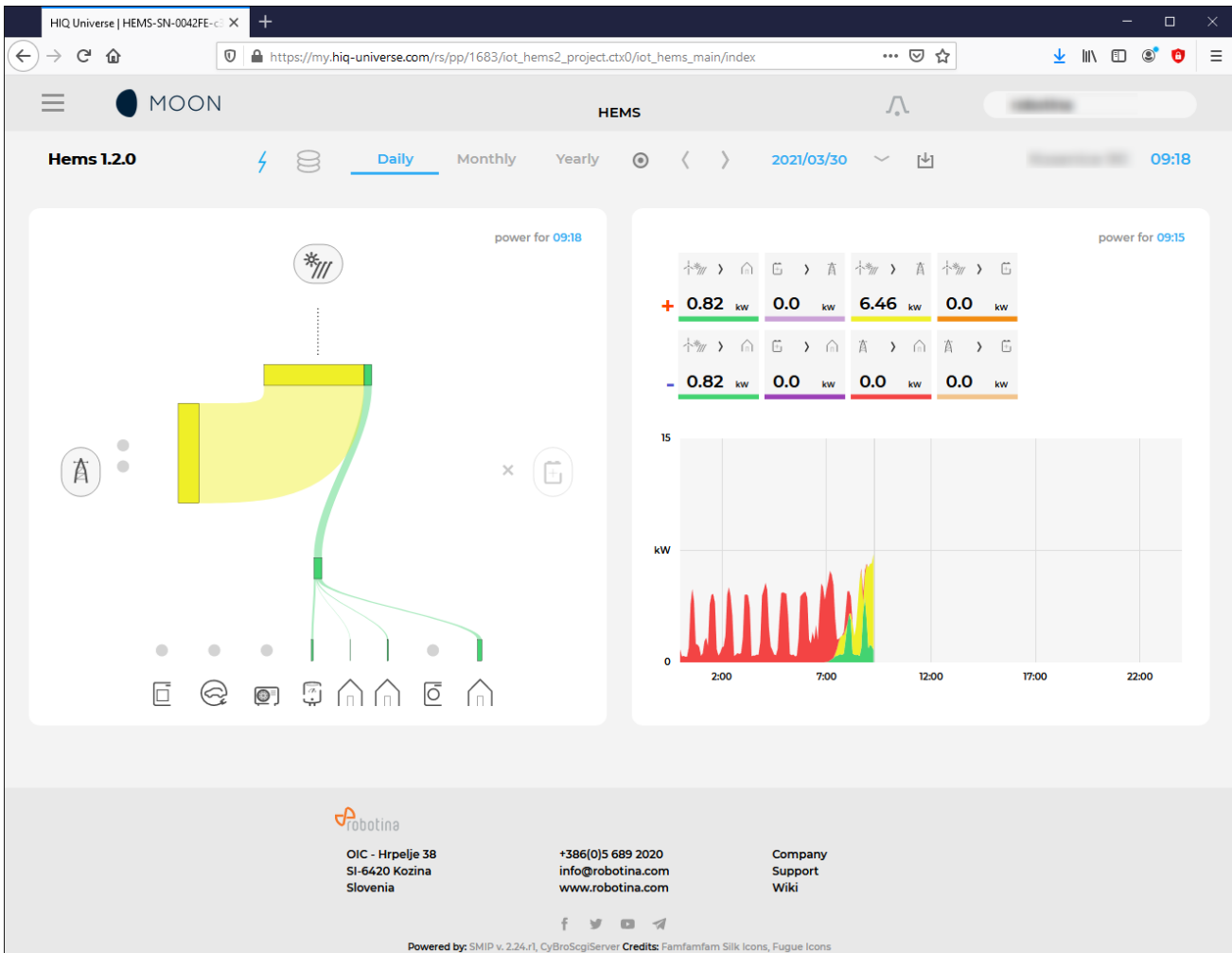

Main HEMS page consists of 3 sections:

- "Title and view selection row" at the top
- "Power flow chart" on left side
- "Power and energy time-plot" on right

Title and view selection row



From the left:

- HEMS name
- Lighting icon → time-plot displays energy or power
- Money icon → time-plot overlays currency graph
- Daily → time-plot displays power
- Monthly → time-plot displays energy per day
- Yearly → time-plot displays energy par month
- Target icon → time-plot go to now
- < → time-plot goes to previous term
- > → time-plot goes to next term
- Date → Select term for time-plot

- Download icon → Download “csv” data for displayed time-plot period
- Location of HEMS installation
- Time at HEMS installation site.

Power flow chart

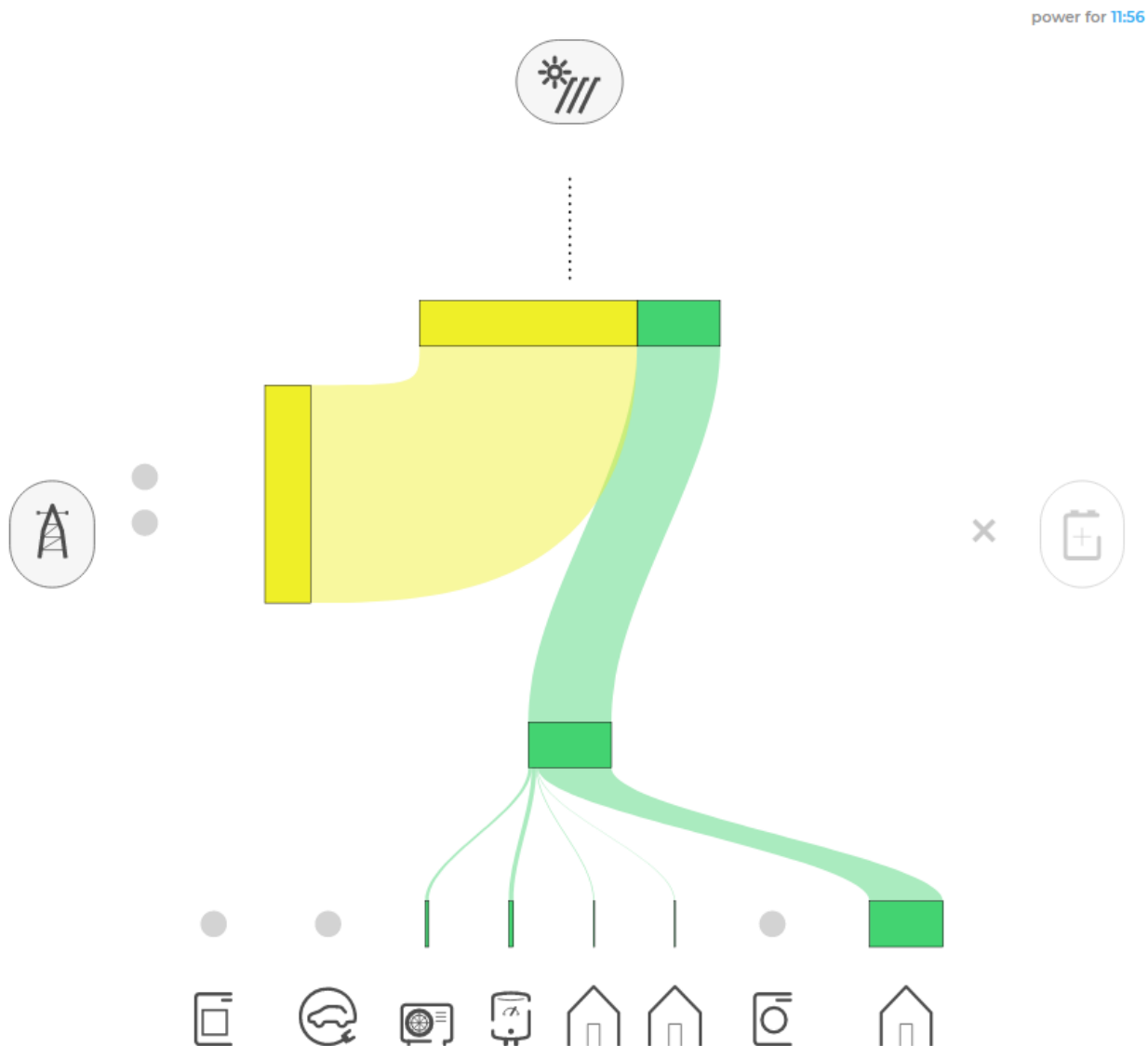

Displays actual power flow with:

- Power sources (Local PV, wind, co-generation plants) at top
- Grid (divided by tariffs) on left side
- Storage (battery) systems on right side and
- Consumers on bottom.

Unused items are soft greyed out with X. Items without actual power are displayed as dots. Clicking on a devices displays current power flow for selected device.

Power and energy time-plot

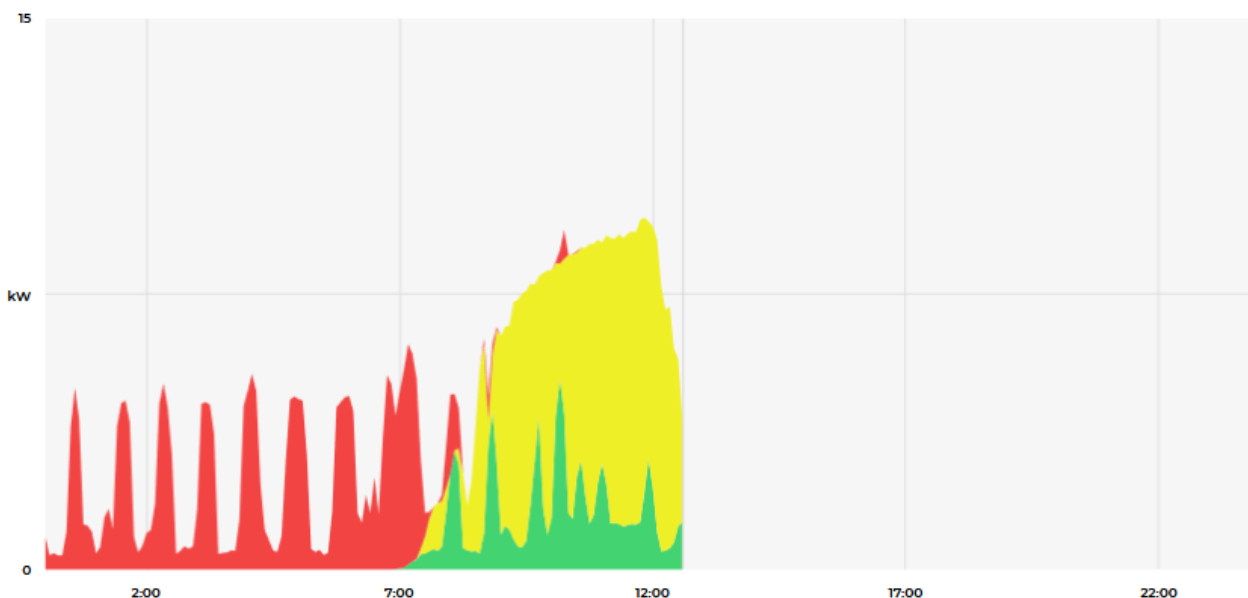
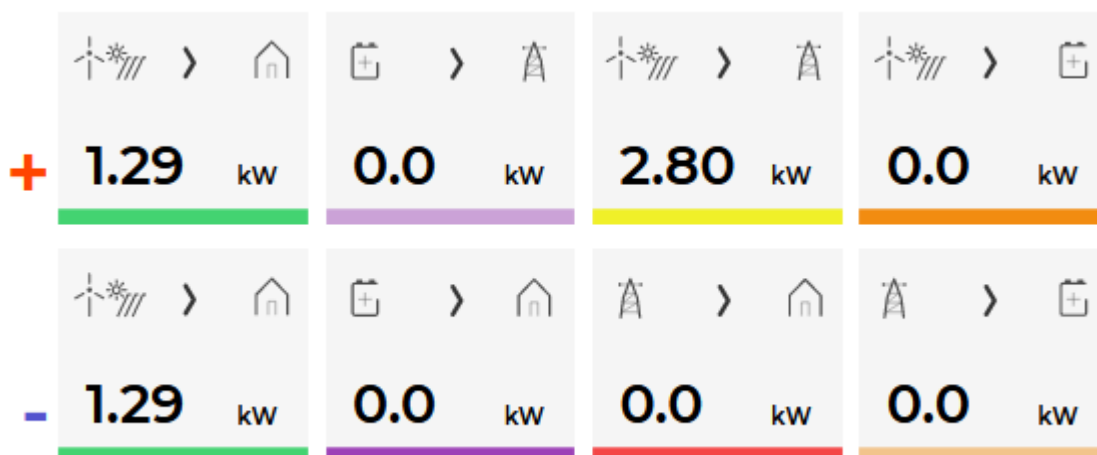

On bottom is time-plot for selected time period (in title row). By clicking on time plot a term for legend display is selected. Above there is power/energy legend.

Side menu

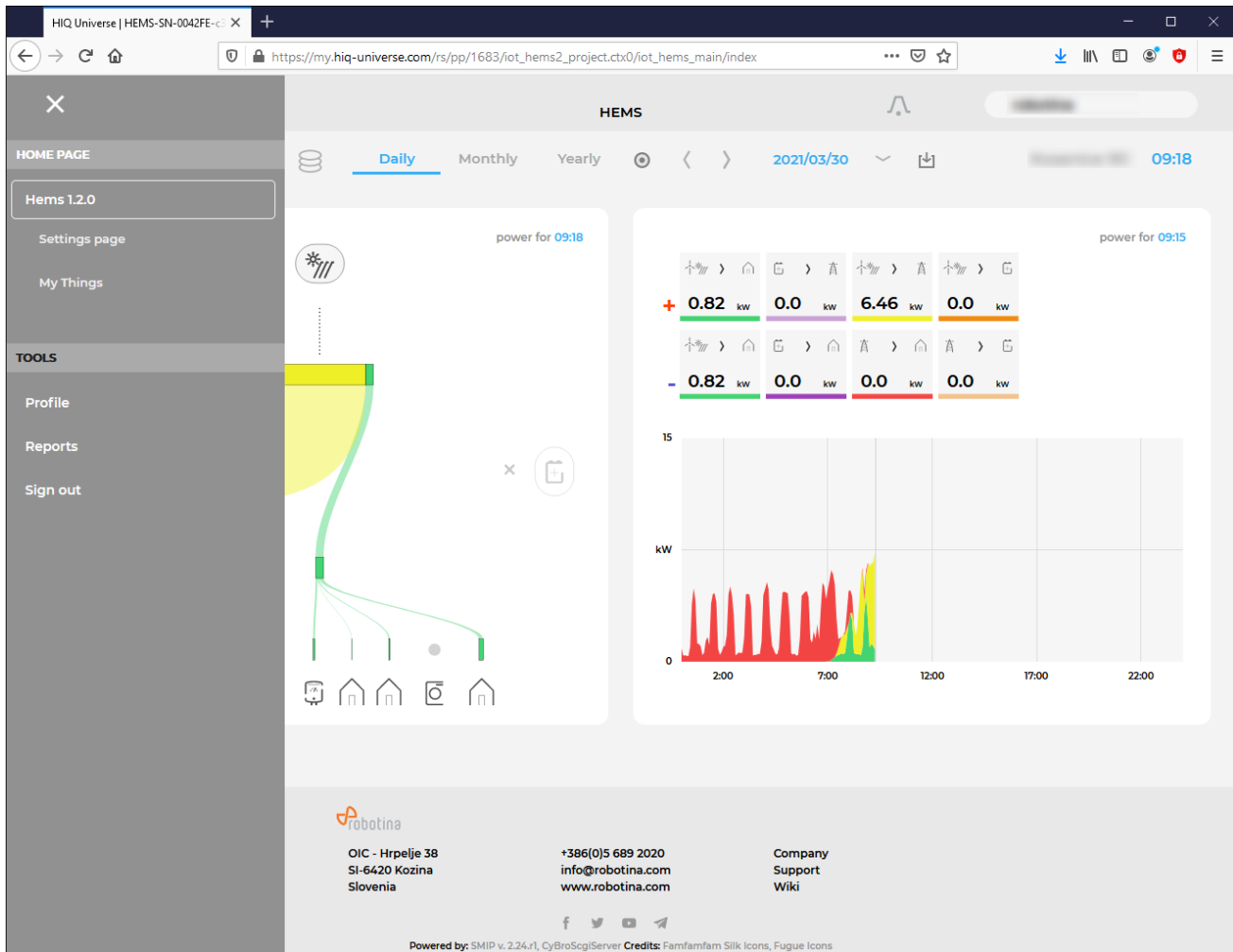

Side menu is activated by clicking menu icon (tree vertical lines at top-left). Menu items are dynamic created so can be different for each user. Typical menu items from top:

- Home page → section with all your subscribed HIQ Universe devices and services
 - Hems 1.2.0 → "Main HEMS view"
 - Settings page → "HEMS settings"
 - My Things → "My Things"
- TOOLS → section with general site tools
 - Profile → "User profile set-up"
 - Reports → "System reports"
 - Sign out → Log off from HIQ Universe

HEMS settings

HIQ Universe | Settings page

https://my.hiq-univer: 70%

Settings page

Device

HEMS-SN-0042FE-c30567-Dorniz-Wiki

MC serial number ?

Device name

Location

Location name

Location latitude

Location longitude

Time Zone

Energy price

Currency

Low tariff price (€/kWh)

High tariff price (€/kWh)

Feed-in tariff price (€/kWh)

Timeplots range

Electricity

Max daily power (kW)

Max daily energy (kWh)

Max monthly energy (kWh)

Cost

Max daily value (€)

Max monthly value (€)

Share your device

Owner

Guest account

Guest email address **Remove guest**

Basic settings and info about HEMS.

Sections:

- Settings:
 - Device serial number
 - Device name
 - Location name and coordinates, timezone
- Energy price: per tariff energy price
- Timeplots range: ranges for various timeplots
- Share your device: manage device sharing guest accounts

My Things

The screenshot displays the 'My Things' dashboard in a web browser. The page is organized into several sections:

- Consumers:** A grid of eight cards showing power consumption for different areas:
 - Poraba pritičje: 181 W
 - 1. nadstropje: 27 W
 - Mansarda: 325 W
 - TČ ogrevanje: 0 W
 - TČ sanitarna: 135 W
 - Kuhinja: 0 W
 - Pečica: 0 W
 - Polnilnica: Available, 3 phases, 0 W power, 20 A max current, 0 h 0 min last session, 0 Wh energy.
- Production and grid:**
 - PV:** 7728 W
 - Grid:**

Voltage L1:	225 V
Voltage L2:	226 V
Voltage L3:	230 V
Frequency:	50.02 Hz
Tariff:	LO
Current L1:	-11.8 A
Current L2:	-11.8 A
Current L3:	-11.3 A
- Storage:** (Section header)
- Sensors:** (Section header)

System overview of connected devices.

Sections:

- Consumers:
 - Up to 8 consumers
 - On/Off control
 - Overview of energy and status
 - Settings:
 - Manual override (Minute countdown of manual control until cloud can perform optimizations again)
 - Cloud optimizations with timetable
 - Current limiter with priorities
 - History:
 - Power overview
- Production and grid:
 - Overview of grid and up to 3 other energy sources
- Storage
 - Overview of up to 2 battery sources
- Sensors
 - Supported for temperature and humidity sensor

Consumers

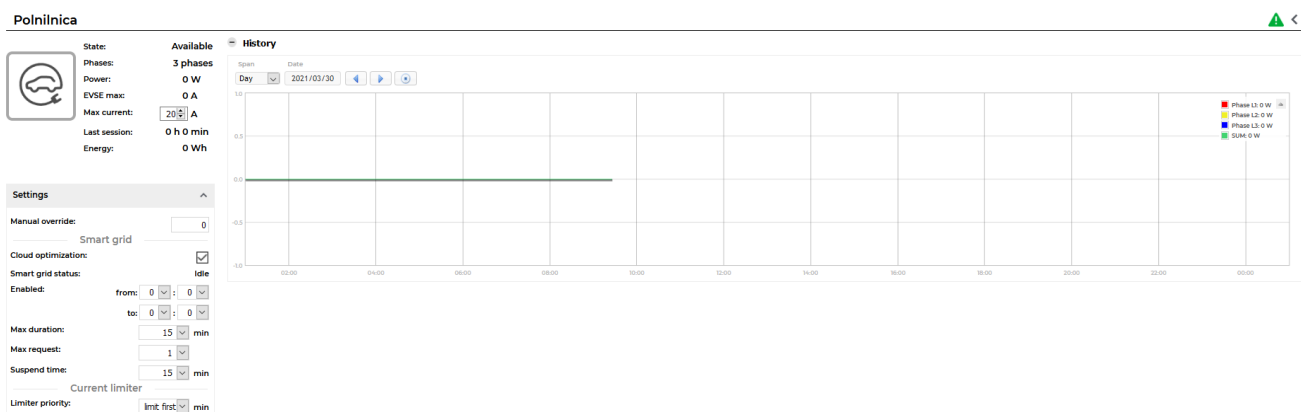

Overview of energy and status of consumers, on/off control and additional settings.

Example EV charger:

- EV charger on/off control¹
- EV charger info
- User set max charging current
- Charging session duration and energy
- Cloud optimizations with timetable
- Current limiter settings²
- History power graph

¹ Icons with square border can be turned on or off. Thick solid grey border state ON, slim grey border OFF, no border control is disabled.

² Consumers with enabled limiter have green icon when limiter is inactive and yellow icon when active. If limiter is disabled there is no icon.

Production and grid

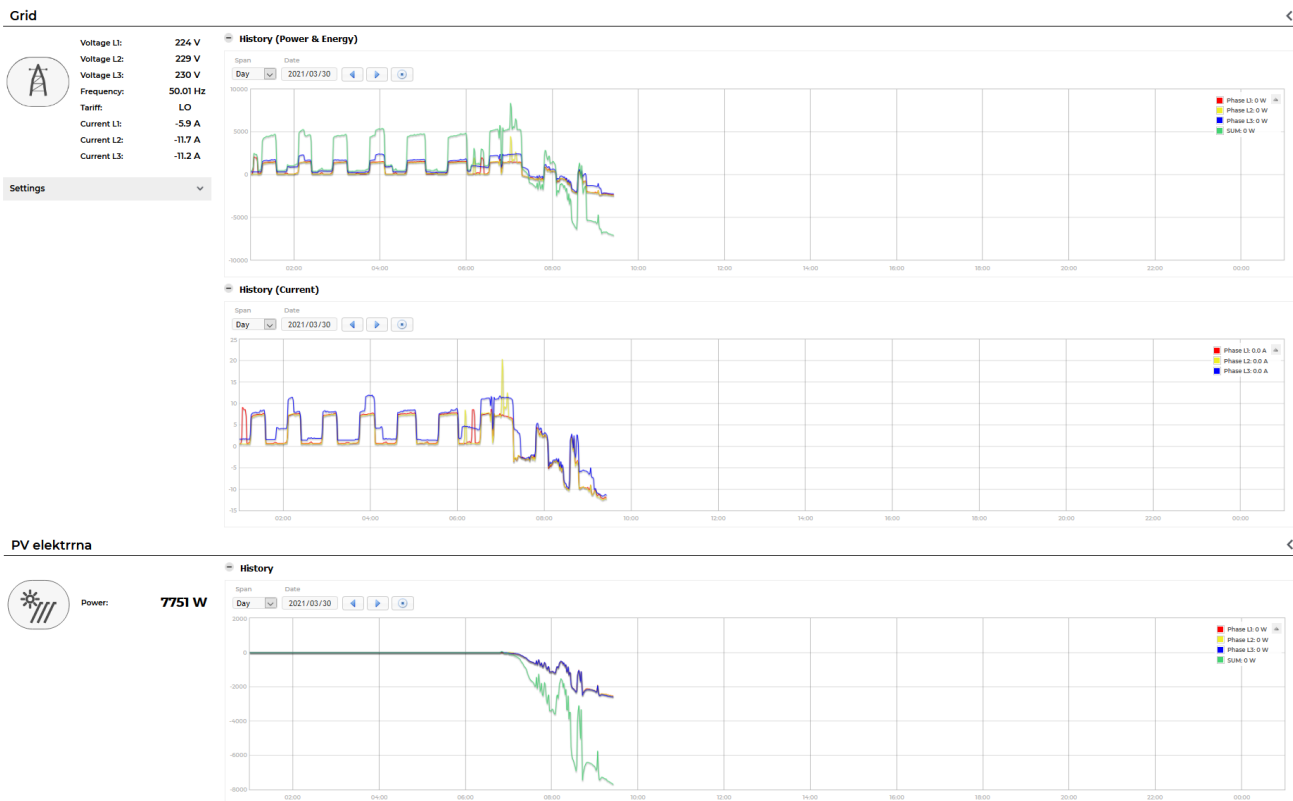

Overview of energy from grid and other sources.

Status:

- Voltage
- Frequency
- Tariff
- Current
- Power

User profile set-up

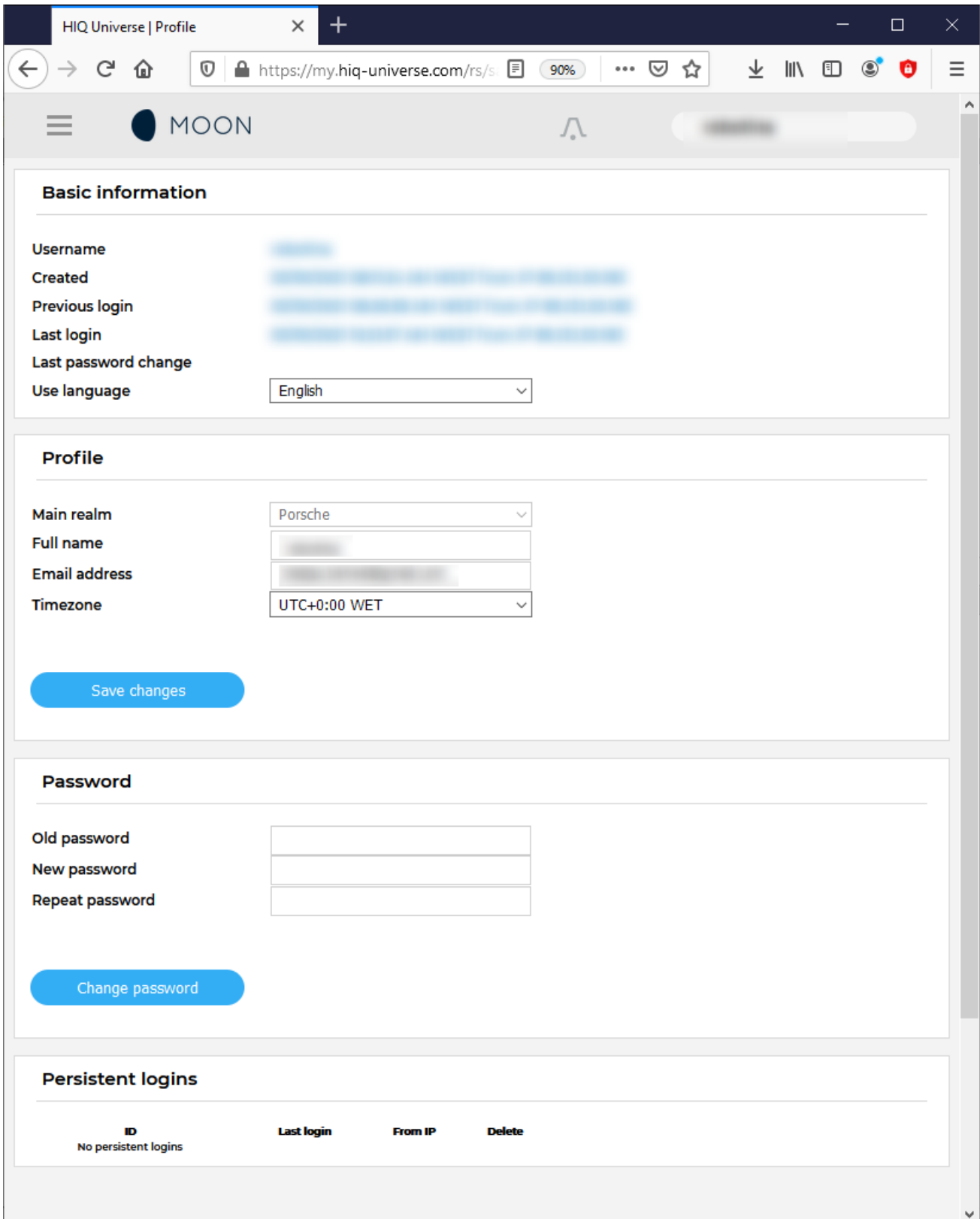

Basic information section:

- Username
- Created date and IP
- Previous and last login date and IP
- Last password change date and IP
- User language

Profile section:

- Main realm display
- Full name, email address and timezone edit fields

Password:

- Fields for password changing

Persistent logins:

- Data of access from persistent logins

System Reports

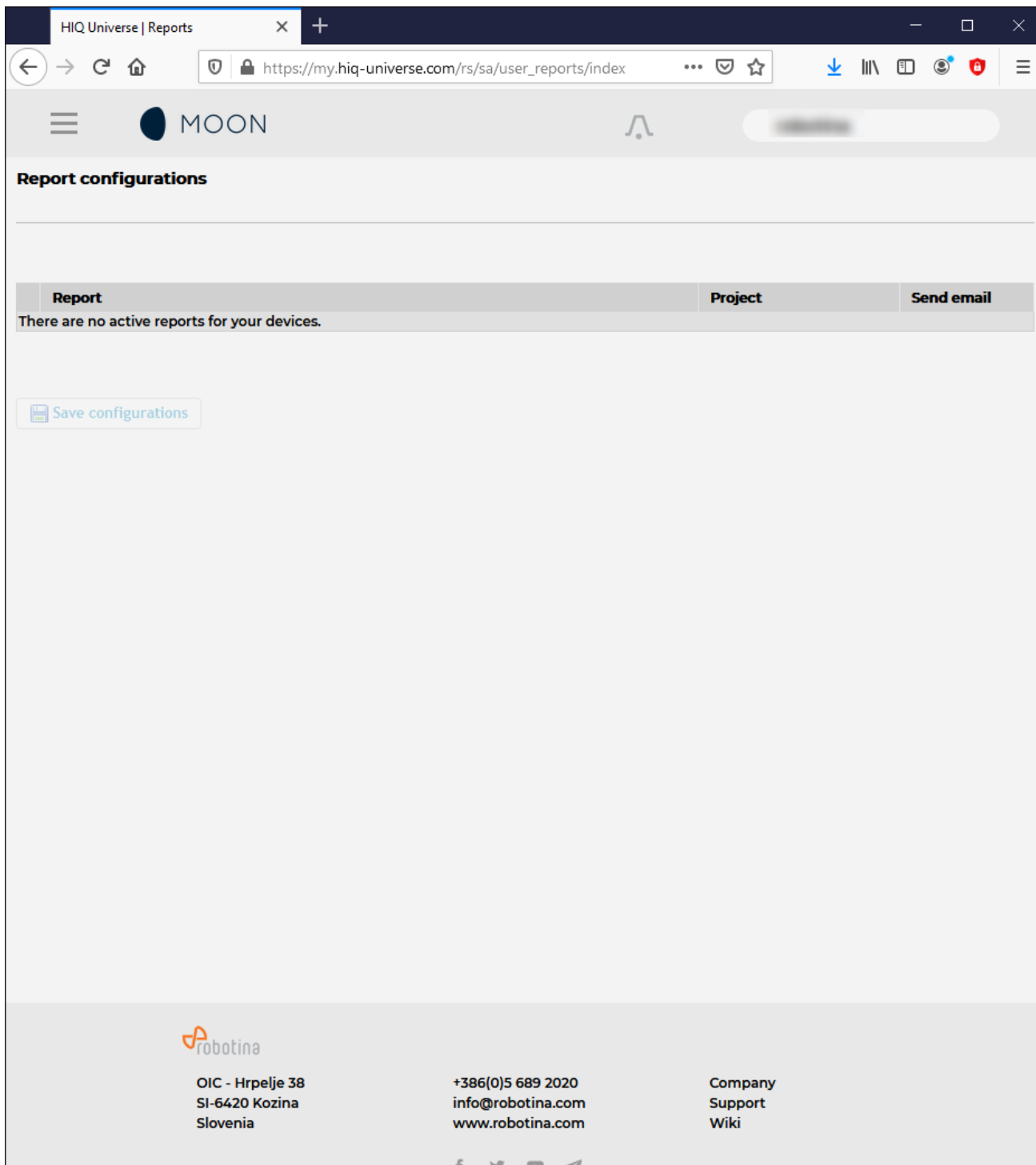

System generated reports can be found here.