

Project number

Project name

Date

16-ROB-036

HIQ Mobile Demonstration Set

6/7/2016

Drawing number

Drawing version

Year of construction

01

01

2016

Supplier

Customer

Robotina d.o.o.

OIC Hrpelje 38

6240 Kozina

Slovenia

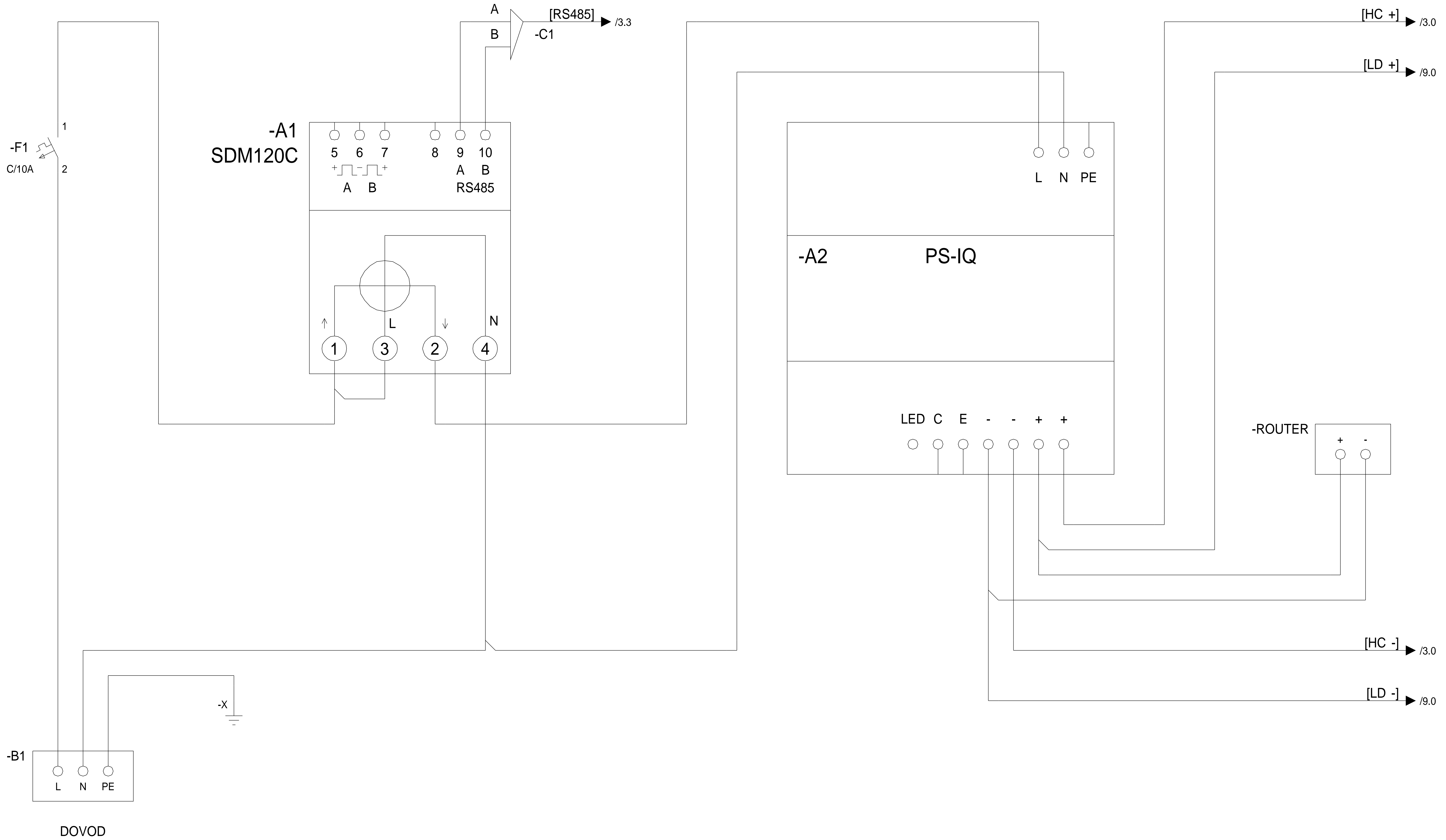

				Last changed by GK	 Robotina d.o.o. OIC Kozina 38 SI-6240 Kozina	WIRING DIAGRAM HIQ Mobile Demonstration Set	Drawing number	Installation =
			Last changed 6/7/2016	01			Location +	
Rev	Revision text	Signature	Date	Print date 6/7/2016			Pages 10	Page number 2

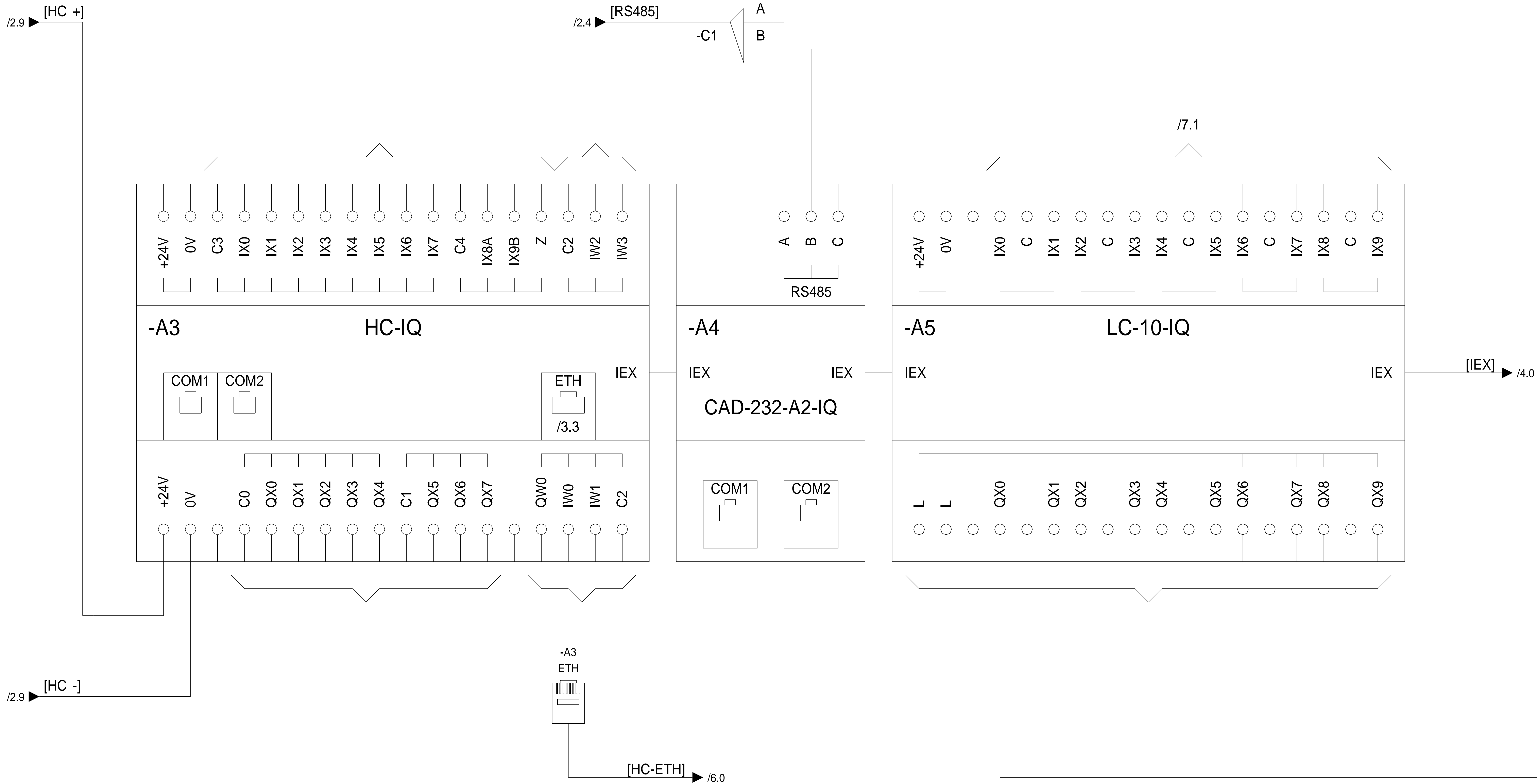

HIQ Firmware preinstalled
 For additional info see: wiki.hiq-home.com

Rev	Revision text	Signature	Date
-----	---------------	-----------	------

Last changed by GK	 Robotina d.o.o. OIC Kozina 38 SI-6240 Kozina
Last changed 6/7/2016	
Print date 6/7/2016	

WIRING DIAGRAM
HIQ Mobile Demonstration Set

Drawing number	01
Pages	10

Installation	=
Location	+
Page number	3

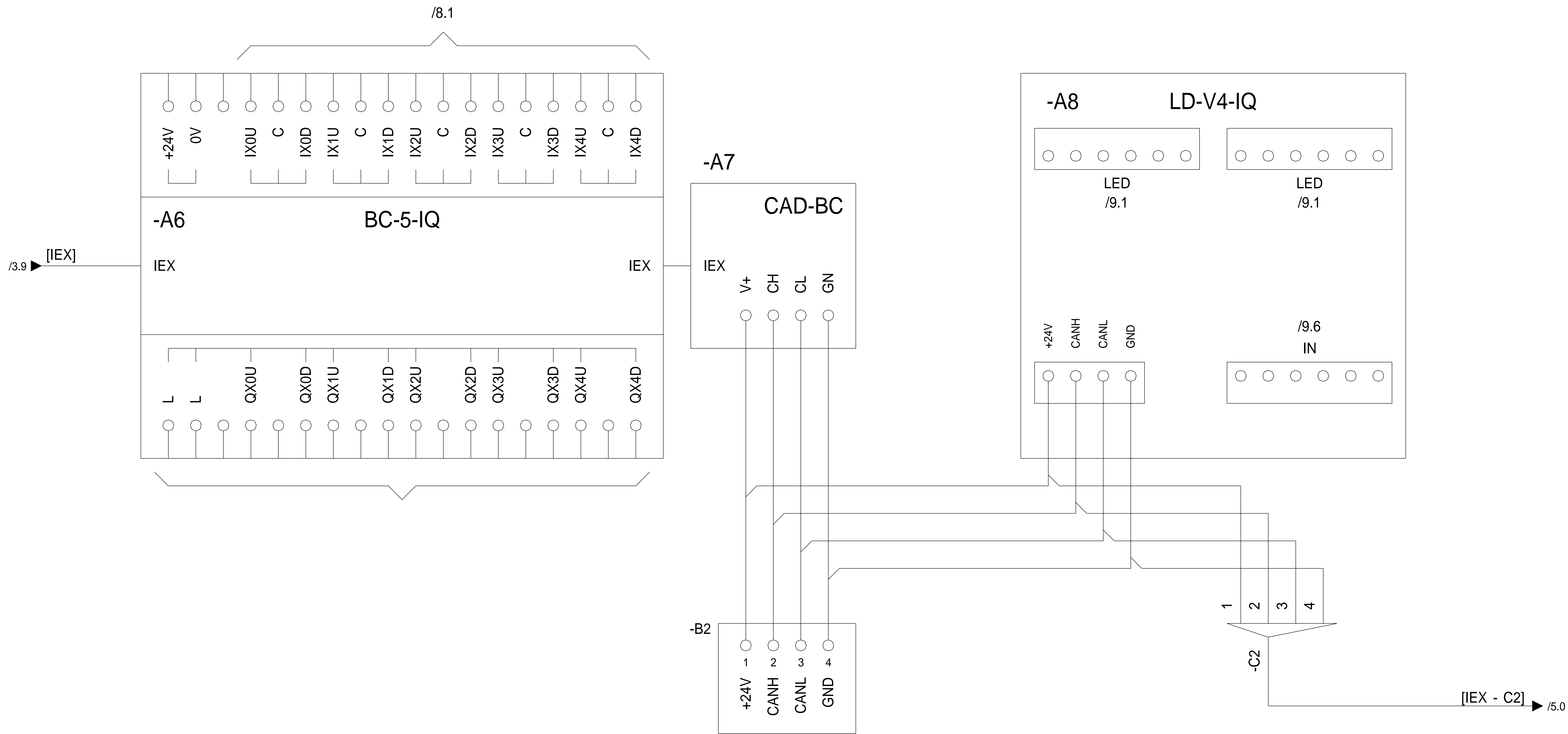

IEX
FIELD MODULES

				Last changed by GK	 Robotina d.o.o. OIC Kozina 38 SI-6240 Kozina	WIRING DIAGRAM HIQ Mobile Demonstration Set	Drawing number	Installation =
			Last changed 6/7/2016	01			Location +	
Rev	Revision text	Signature	Date	Print date 6/7/2016			Pages 10	Page number 4

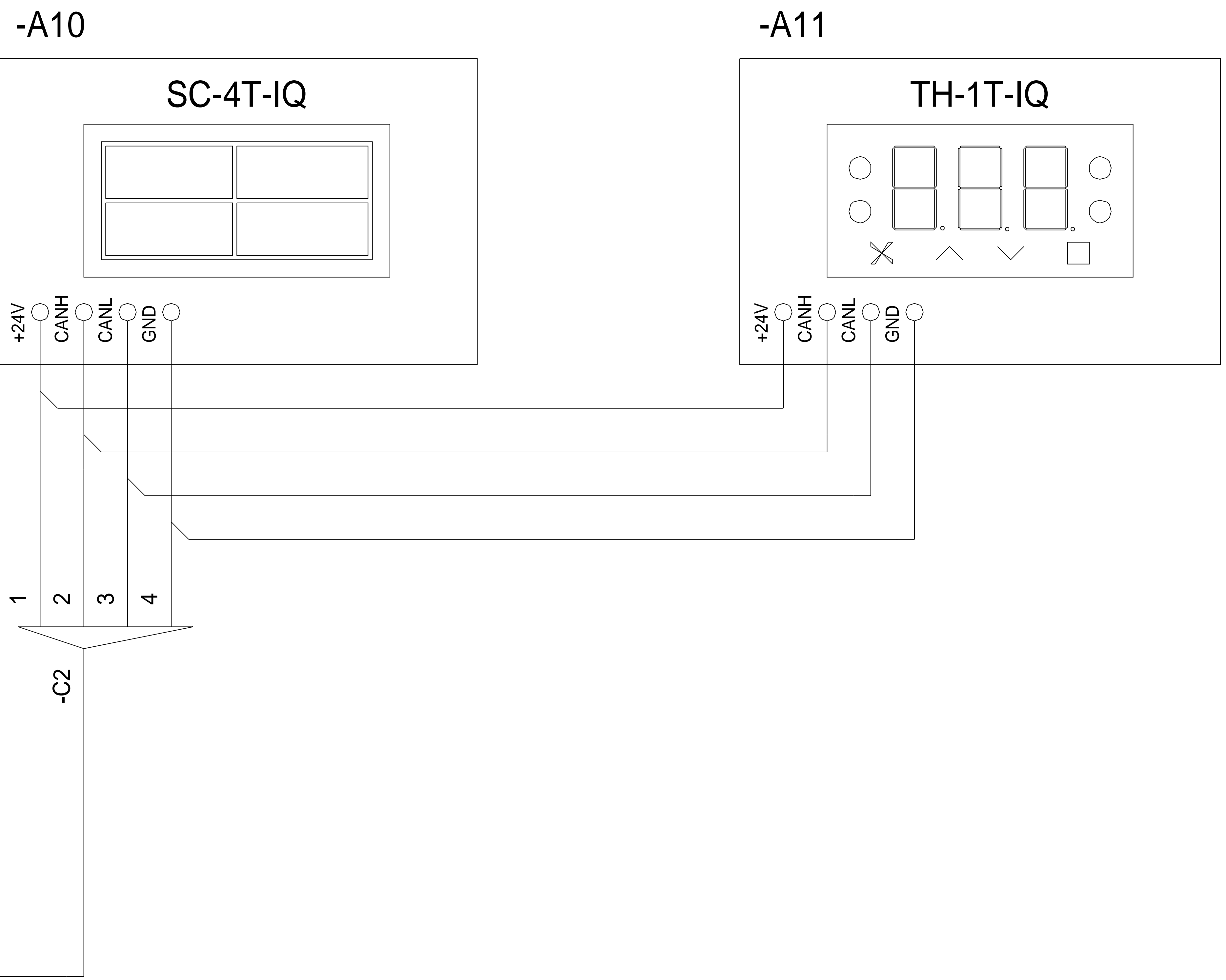

4.9 [IEX - C2]

Rev	Revision text	Signature	Date
-----	---------------	-----------	------

Last changed by GK	 Robotina d.o.o. OIC Kozina 38 SI-6240 Kozina
Last changed 6/7/2016	
Print date 6/7/2016	

WIRING DIAGRAM
HIQ Mobile Demonstration Set

Drawing number	01
Pages	10

Installation	=
Location	+
Page number	5

-A9

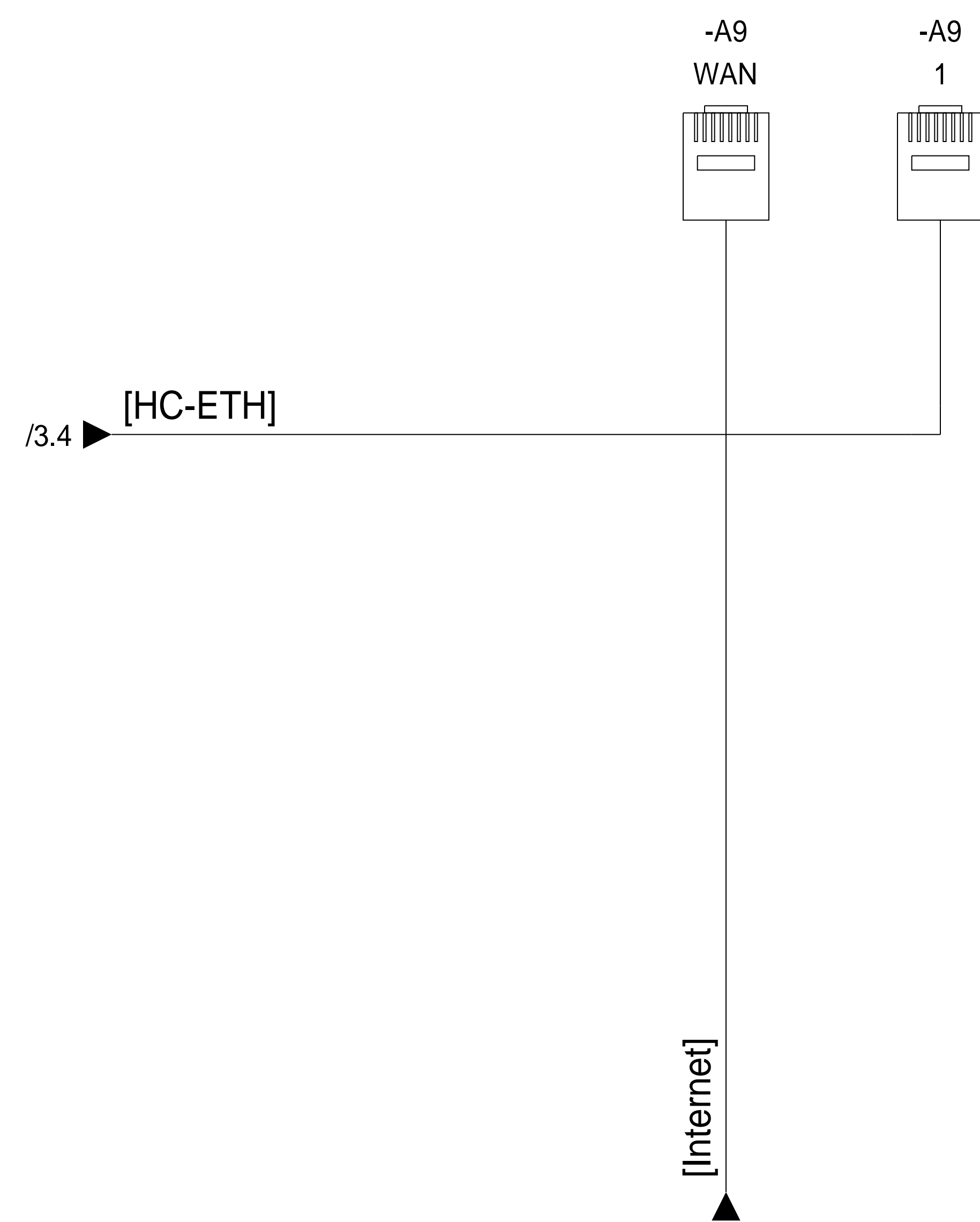
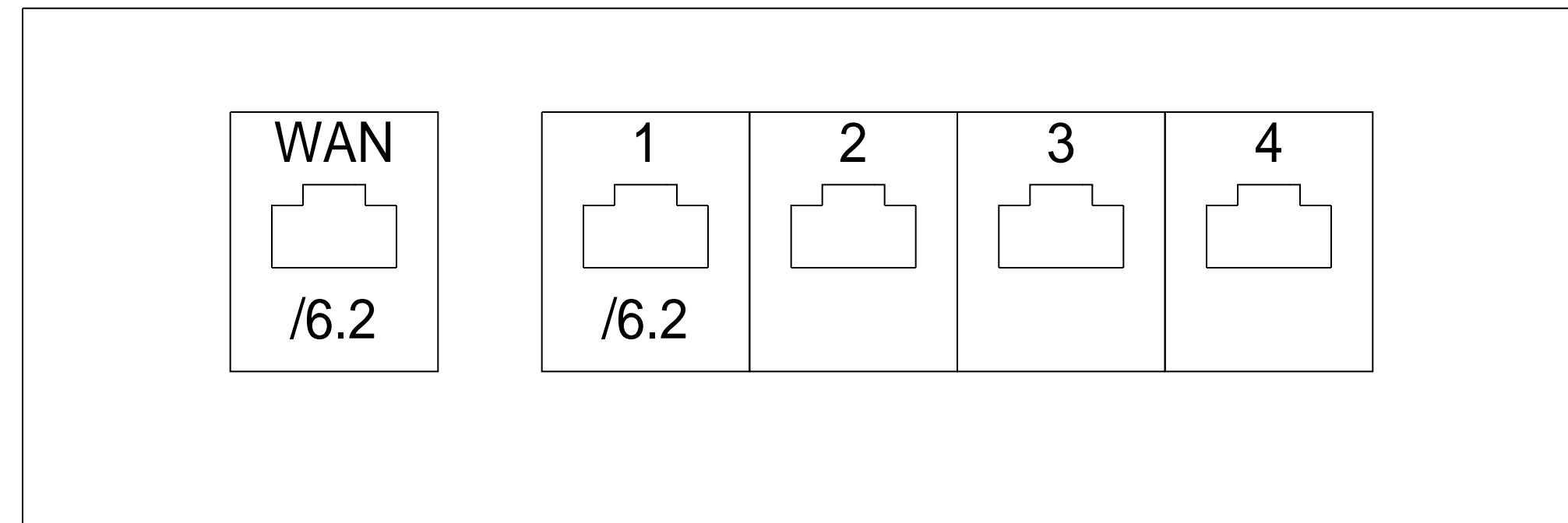

Router:

- IP: 192.168.88.1
- Pass.: robo1990

DHCP server:

- IP range: 192.168.88.100-150
- Mask: 255.255.255.0
- GW: 192.168.88.1
- DNS server: 192.168.88.1

WiFi:

- SSID: HIQDEMO
- PASS: HIQ2016

DHCP enabled LAN with Internet access

				Last changed by GK	 Robotina d.o.o. OIC Kozina 38 SI-6240 Kozina	WIRING DIAGRAM HIQ Mobile Demonstration Set	Drawing number		Installation =
			Last changed 6/7/2016	01			Location +		
Rev	Revision text	Signature	Date	Print date 6/7/2016			Pages 10	Page number 6	



Rev	Revision text	Signature	Date
-----	---------------	-----------	------

Last changed by	GK
Last changed	6/7/2016
Print date	6/7/2016



WIRING DIAGRAM
HIQ Mobile Demonstration Set

Drawing number	01
Pages	10

Installation	=
Location	+
Page number	7

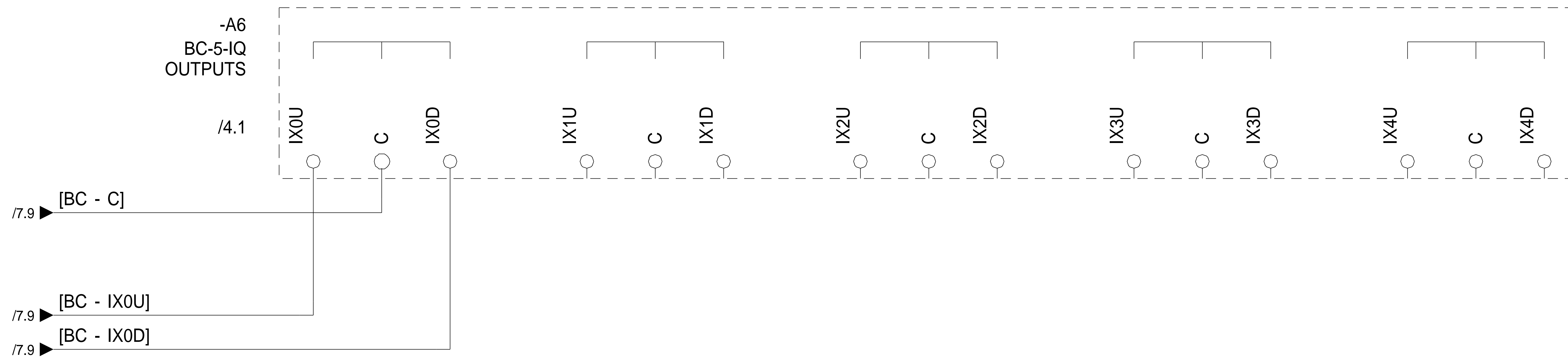

				Last changed by GK	 Robotina d.o.o. OIC Kozina 38 SI-6240 Kozina	WIRING DIAGRAM HIQ Mobile Demonstration Set	Drawing number	Installation =
			Last changed 6/7/2016	01			Location +	
Rev	Revision text	Signature	Date	Print date 6/7/2016			Pages 10	Page number 8

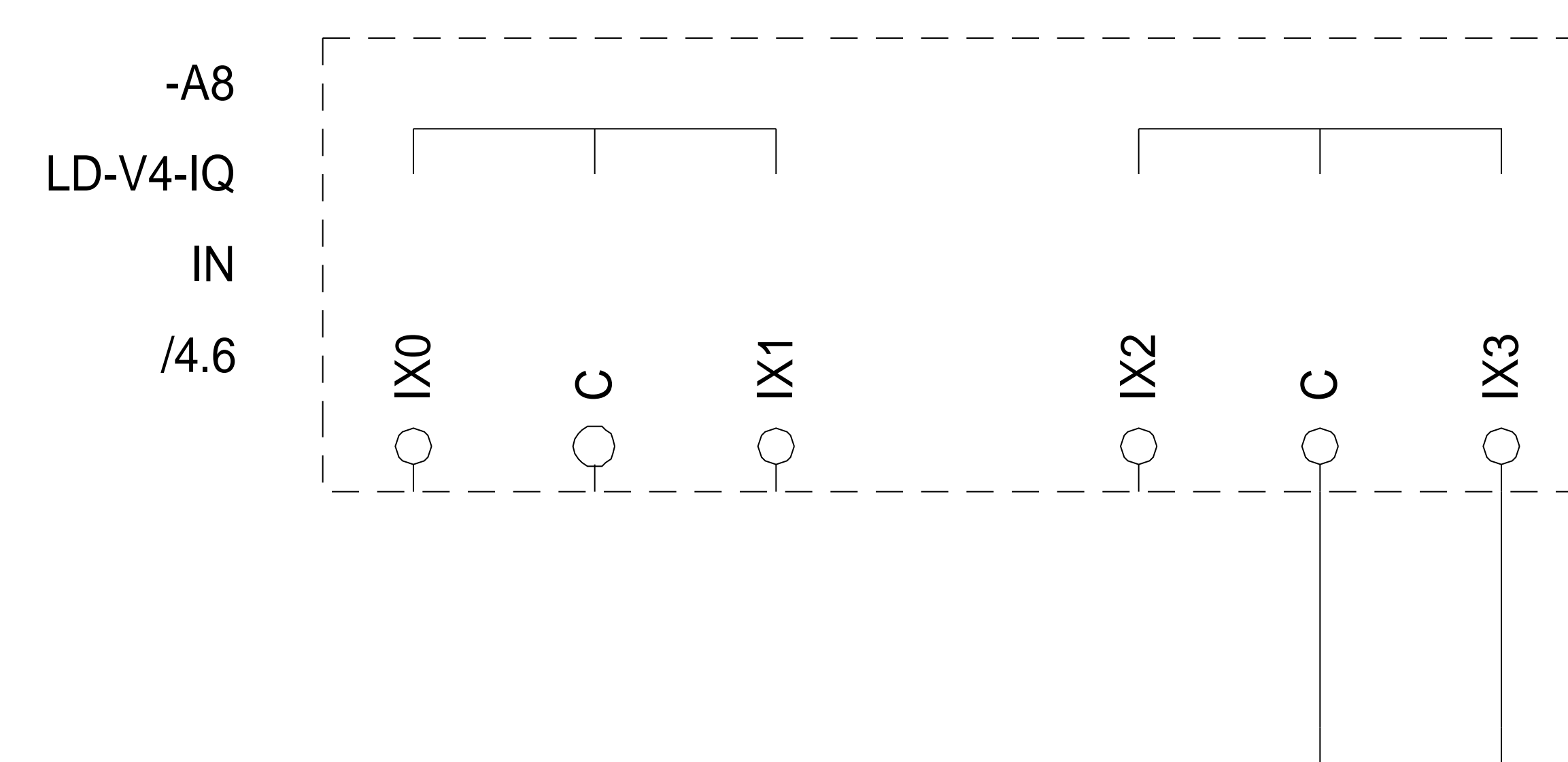
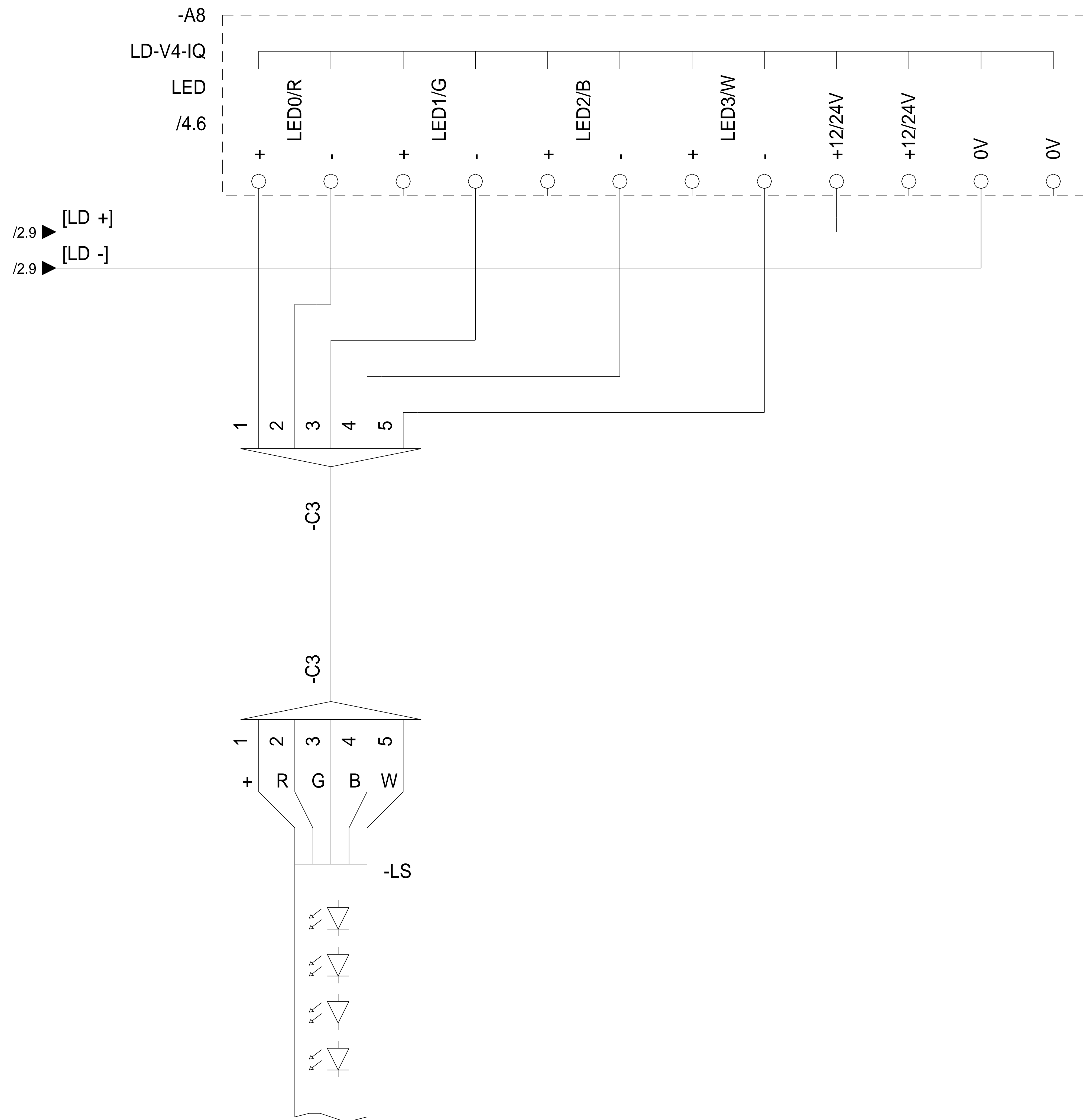

Rev	Revision text	Signature	Date
-----	---------------	-----------	------

Last changed by GK	 Robotina d.o.o. OIC Kozina 38 SI-6240 Kozina
Last changed 6/7/2016	
Print date 6/7/2016	

WIRING DIAGRAM
HIQ Mobile Demonstration Set

Drawing number	01
Pages	10

Installation	=
Location	+
Page number	9

IEX CASE TERMINALS

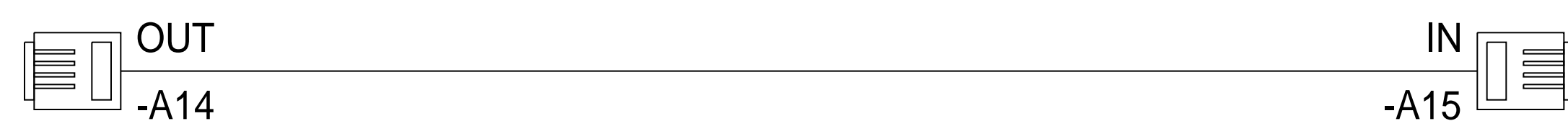
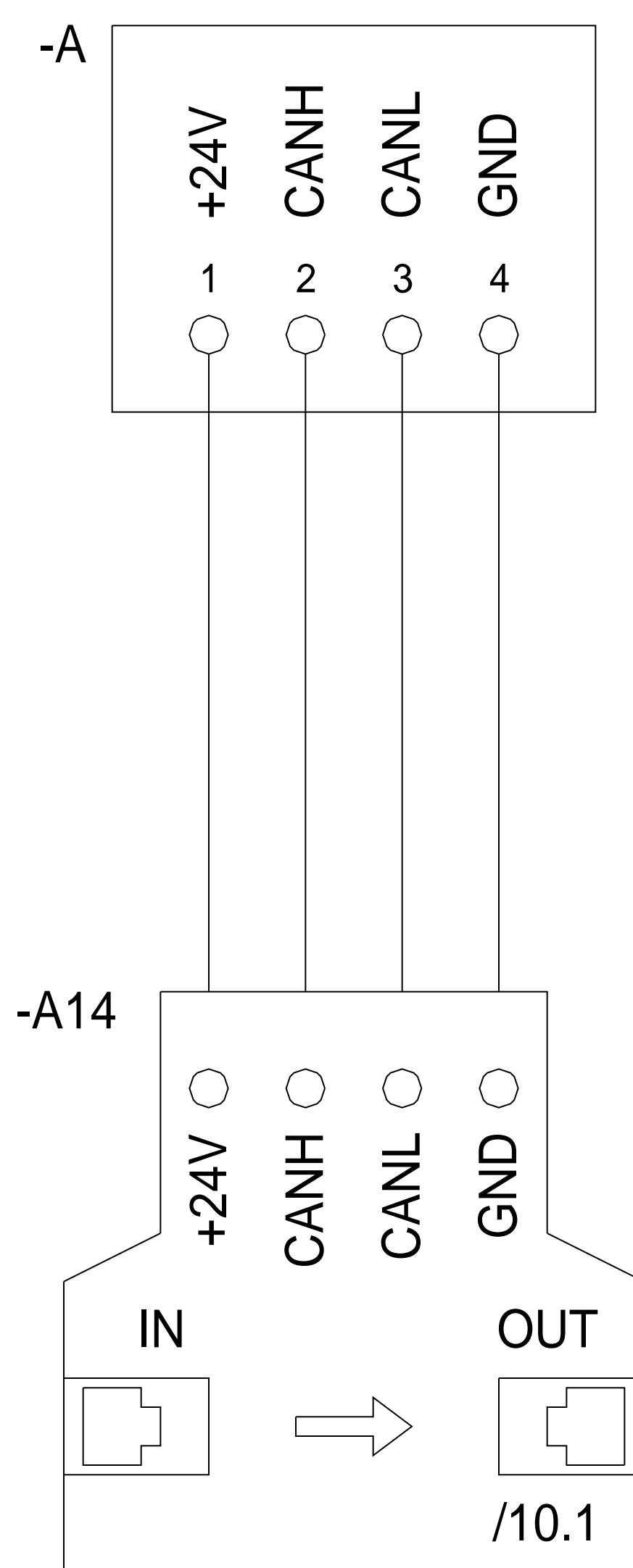

-A12

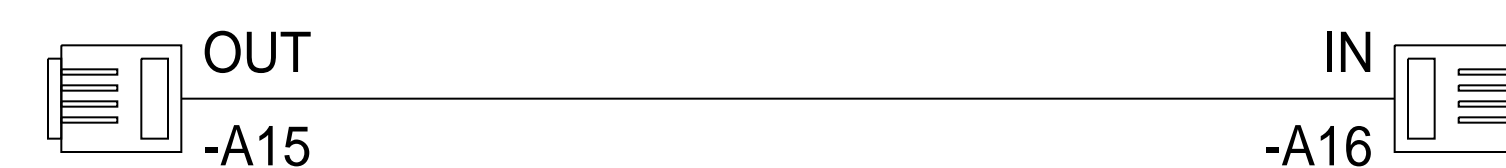
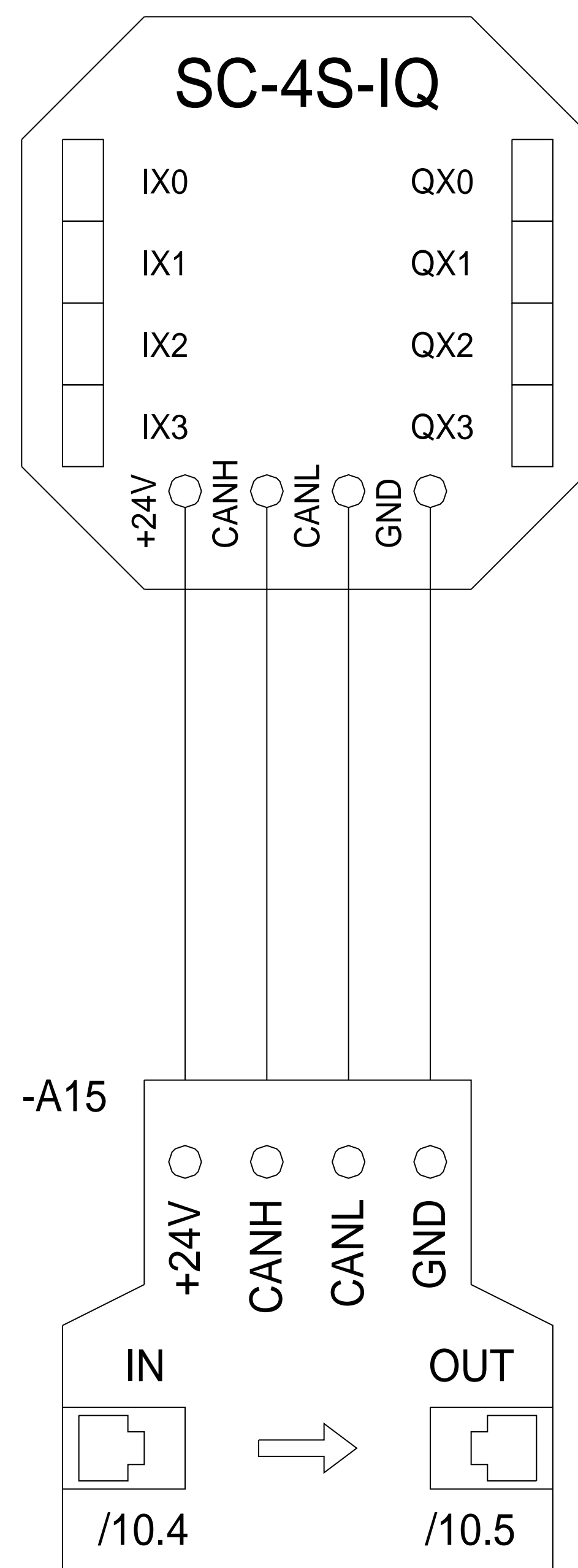

-A13

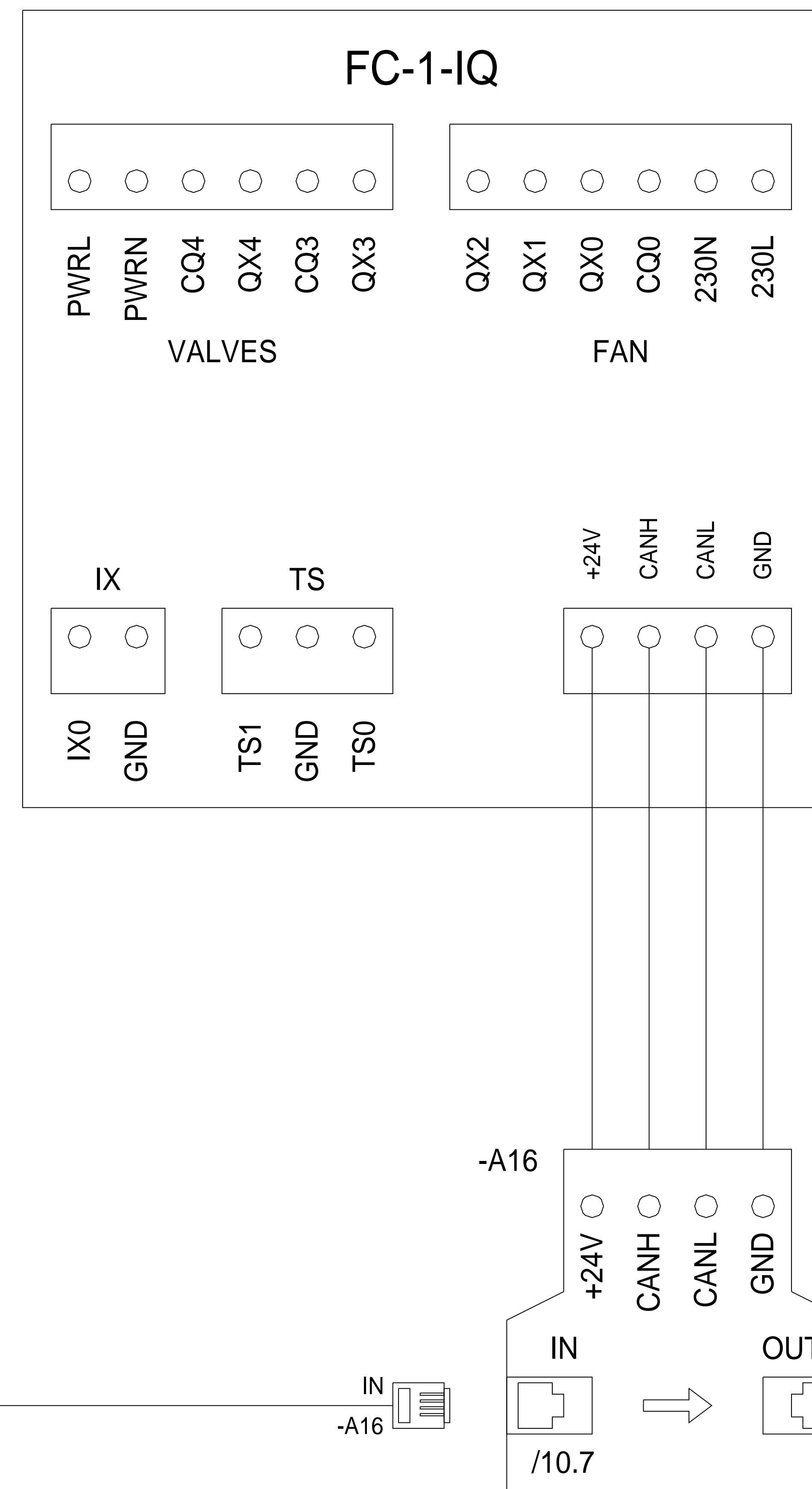

				Last changed by GK	 Robotina d.o.o. OIC Kozina 38 SI-6240 Kozina	WIRING DIAGRAM ACCESSORIES HIQ Mobile Demonstration Set	Drawing number	Installation =
				Last changed 6/7/2016			01	Location +
Rev	Revision text	Signature	Date	Print date 6/7/2016			Pages 10	Page number 10